

PM-238T-96

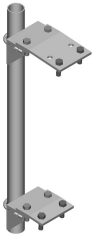

Adjustable Tapered Pipe Mount, 2-3/8 in OD x 96 in

Product Classification

Product Type Pipe mount

General Specifications

Mounting Saddle mounts

Note One 96 in x 8 in panel antenna per pipe mount

Pipe, quantity 1

Tower Taper Tapered

Dimensions

Height 2,438.4 mm | 96 in

Width 152.4 mm | 6 in

Length 152.4 mm | 6 in

Pipe Length 2,438.4 mm | 96 in

Pipe Outer Diameter 60.96 mm | 2.4 in

PM-238T-96

Outline Drawing

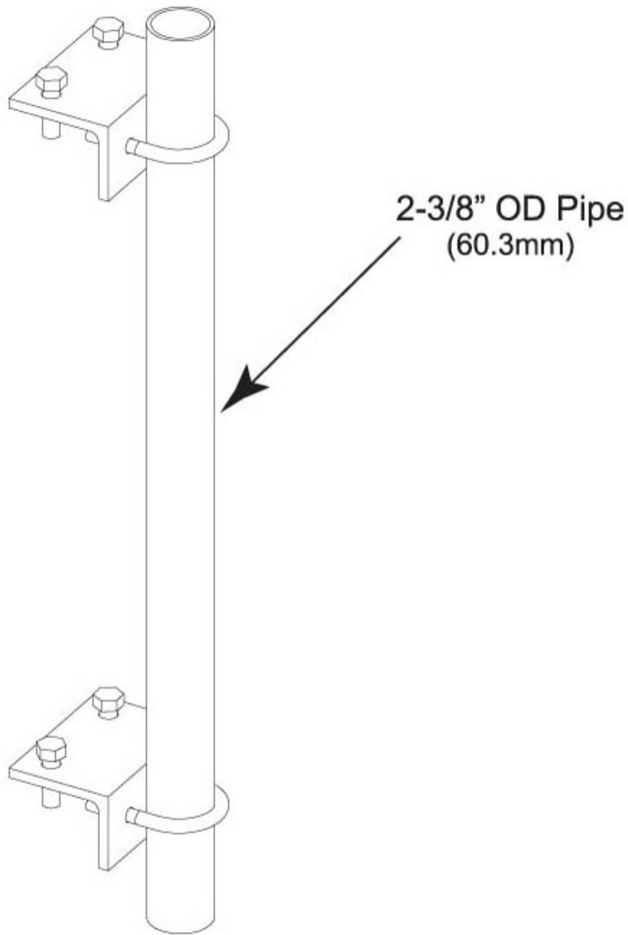

Material Specifications

Material Type Hot dip galvanized steel

Mechanical Specifications

Wind Rating 120 mph (BWS) at 150 ft AGL

Wind Rating Test Method TIA/EIA-222

Packaging and Weights

Included Brackets | Hardware | Pipe

Packaging quantity 1

PM-238T-96

Weight, net

15.2 kg | 33.51 lb

Regulatory Compliance/Certifications

Agency

ISO 9001:2015

Classification

Designed, manufactured and/or distributed under this quality management system



Included Products

- MT-651-96 - Plain End Pipe, 2-3/8 in OD x 96 in .120" A500C 46Ksi
- PM-TK - Pipe Mount Taper Kit

* Footnotes

Wind Rating

BWS—Base Wind Speed; FBC—Florida Building Code