



NG4 access

Optical distribution frame (ODF) platform

2023 PRODUCT CATALOG | 4TH EDITION

COMMSCOPE®

Contents

Meeting the challenges	3
Understanding the NG4access ODF platform	4
Empty frame	7
Rear fiber optic terminal storage panel (FOTSP)	8
Empty frame with integrated FOTSP	9
Equipment frame	10
Universal chassis	11
E-series chassis	12
8-Inch FCM Optical Distribution Frame Fiber Termination Panel	13
9-Inch LSX Optical Distribution Frame Fiber Termination Panel	14
5-Inch LSX Optical Distribution Frame Fiber Termination Panel	15
NG4access Optical Distribution Frame Solutions (2RU NG4 Chassis)	16
Universal adapter packs	17
Cabled modules with preterminated IFC	18
Cabled modules with rollable ribbon indoor/outdoor jacketing	20
Cabled modules with 24-fiber microcable	21
Cabled modules with 24-fiber rollable ribbon cable	22
Microcable fanout mounting bracket kits	23
MPO modules	24
Value-added modules	25
Splice chassis	30
Splice tray	30
Pigtail cabled module with 24-fiber microcable	31
Accessories	32
Splice protection sleeves	32
Cable clamp kits	32
Raised floor cable entry clamp kit	32
Mesh breakout kits	33
Breakout kit for ribbon in loose buffer tube (RLBT) OSP cable	34
Breakout kit for ribbon central tube (RCT) OSP cable	35
RCT breakout kit typical configurations	36
Breakout kit for intrafacility (IFC) ribbon cables	37
IFC breakout kit typical configurations	38
Frame extender	39
End guard	39
Frame installation kits	39
Frame transition kits	39
Isolation pad	40
Replacement access tray	40
Replacement access tray door kit	40
Rear chassis door kits	40
Designation cards	40
1.2 mm patch cords	41
FiberGuide FlexExit	42

Meeting the challenges of tomorrow's high fiber count networks

Today's data-intensive services are driving the need for ever-increasing network speeds and bandwidth capacity in the central office, head end and data center environment. This is creating the need for more connections between active equipment, and more fiber is being brought in to serve those connections. For service providers, these higher fiber counts and fiber densities can create challenges at the optical distribution frame, particularly where it comes to ease of access and identification of fibers and connectors.

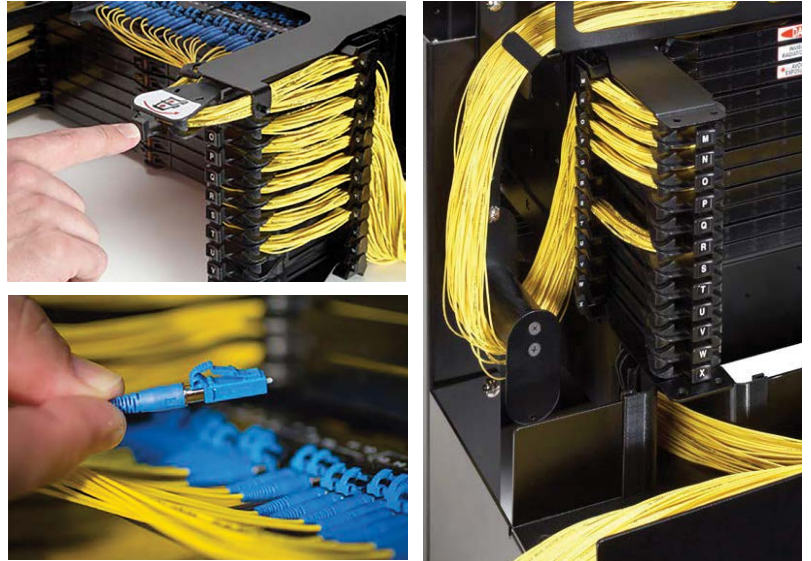

Today's ODF solutions need to be engineered and configured for fast deployment, ease of connectivity and with the least amount of risk to the network as possible, as well as the ability to reconfigure, expand the network and implement new services. CommScope's NG4access optical distribution frame (ODF) platform was built from the ground up to provide superior access to high density fiber terminations. With innovations such as CommScope's access trays, universal adapter packs, cabled modules and MPO modules, installing and maintaining large amounts of fiber can be done faster, easier and less expensively than any previous ODF solution available on the market.

CommScope's NG4access ODF Platform delivers the crucial elements of fiber cable management: connector and cable accessibility, bend radius protection, cable routing paths and physical protection. If these elements are executed correctly, the network can deliver its full competitive advantages.

Connector and cable access: Allowing easy access to connectors and installed fibers is critical in maintaining proper bend radius protection. The NG4access ODF ensures that any fiber can be installed or removed without inducing a macrobend on an adjacent fiber. The accessibility provided by features such as CommScope's craft friendly access trays can have a significant impact on network

reconfiguration time. Accessibility is most critical during network reconfiguration operations and directly impacts operation costs and network reliability.

Bend radius protection: Simply put, optimal signal flow ensures network performance and reliability. CommScope's NG4access ODF ensures that the proper bend radius is maintained to prevent attenuation and deliver the highest possible performance as well as long-term reliability.

Note: Reduced bend radius cable solutions, while offering a tighter bend radius, are not a substitute for well-engineered cable management.

Cable routing paths: Improper technician routing of fibers is one of the major causes of bend radius violations. The NG4access ODF is extremely craft friendly, and provides routing paths that are clearly defined and easy to follow—leaving no room for guesswork and ensuring that technicians can easily trace and locate fibers.

Physical protection: All fibers should be protected throughout the network from accidental damage by technicians and equipment. Fibers routed between pieces of equipment without proper protection are susceptible to damage, which can critically impact network reliability. CommScope's robust fiber cable management technology ensures that every fiber is well protected and designed to withstand daily wear and tear.

Understanding the NG4access ODF platform

CommScope's NG4access ODF frame is Telcordia® GR-449-CORE, Issue 3 compliant and designed to meet today's high-density network needs. The frame is designed with an emphasis on superior cable management and ease of use, including features such as ample trough space for cable and jumpers, front and rear access to cable and connectors and storage for jumpers. The frame sections are shipped from the factory fully equipped with all cable management hardware including integrated jumper slack storage. The frame will hold six universal chassis.

Chassis

CommScope's NG4access universal chassis supports configurations up to 576 terminations with LC adapter packs or 288 terminations with SC adapter packs. Each chassis includes 24 access trays that can hold adapter packs, cabled modules, MPO modules, or a combination of each. Craft-friendly design, the chassis features the same interface on the front and back side of unit.

Adapter packs

Adapter packs are available in LC-12 and SC-6 pack configurations. Two adapter packs snap into a single access tray. Each chassis can be loaded with up to 48 adapter packs. Adapter ports are staggered for easy connector insertion/removal, and help to clearly identify individual adapter ports. A single adapter pack will promote universal applications, including singlemode and multimode, and angled and ultra polished connectors.

Cabled modules

LC and SC cabled modules enable the routing of fiber cable to the frame, where multiple connectors are terminated to the frame with a single click. Cabled modules with integrated connectors ensure the cables are kept in sequential order, and help prevent accidental fiber breakage or disruption to adjacent fibers during installation. Cabled modules are available in a pigtail version for splicing on frame or preterminated to 24-fiber microcable or conventional IFC cable.

MPO Modules

The MPO module offers the same craft-friendly interface for LC and SC connectors as the cabled module, but include a rear low-loss MPO adapter to allow the installer to connect an MPO trunk cable to turn up services in rapid installation applications.

Value-added modules

NG4access VAMs help enhance optical transport systems by providing flexible, easy to incorporate optical components into the network for increasing fiber capacity, troubleshooting, or distributing signals to multiple subscribers.

1.2 mm patch cords

The NG4access ODF leverages CommScope's revolutionary 1.2 mm patch cords. These microcable patch cords require half the space of traditional 1.6 mm patch cords and a third of the space of traditional 2.0 mm patch cords, while maintaining equal performance and handling. 1.2 mm cable incorporates reduced bend radius fiber technology, which is less susceptible to attenuation caused by handling and macrobends.

Splice chassis and trays

The optional splice chassis installs on the NG4access frame and holds up to 48 splice trays. Each tray provides up to 72 fibers, for a total of 3,456 fibers per splice chassis. The splice chassis can be installed without sacrificing overall frame termination density.



Product overview

A detailed list of product specifications are available in the application and planning guide TECP-90-701.

Recommended applications:	Medium to large fiber count applications. GR-449-CORE, Issue 3 compliant
Description:	High density ODF uses 24-position access trays in configurations of up to 576 terminations in a single chassis
Number of Fibers, future growth potential:	Up to 3,456 per frame
Flexibility/ability to grow:	Yes
Footprint:	30" W x 24" D
Interconnect:	Excellent
Cross-connect:	Excellent
Accommodates on-frame splicing:	Yes. Up to 3456 splices without sacrificing termination capacity
Rear access:	Yes
Front access:	Yes
Density – terminations per frame:	3456 LC terminations per frame, 1728 SC terminations per frame
Slack storage location:	On-frame (integrated jumper slack storage). Optional rear storage panel
Connector access:	Access tray front and rear
Horizontal trough space available to accommodate a 20 bay line-up:	Yes, using 1.2 mm jumpers. 10 sq. inches trough x 6 troughs = 60 sq. inches total space.

Jumper capacities

Front side NG4access ODF jumper wireways are optimized when using 1.2 mm diameter patchcords. At full frame capacity, 1.2 mm patchcords can be used in both interconnect or cross-connect applications while maintaining compliance with the interoperability objectives of GR-449 CORE. Based on packing densities defined by GR-449 CORE, the adjacent chart outlines frame capacities when using different patchcord sizes. Only patchcords using reduced bend radius fiber (G.657.A2) should be used in NG4access ODF's. Rear side NG4access wireways will accept patchcords up to 2.0 mm while achieving maximum capacities for both interconnect and cross-connect applications.

	Jumper diameter (mm)	Cross connect	Interconnect	Interconnect with FOTSP
SC/1728 Terminations	1.2	100%	100%	100%
	1.6	100%	100%	100%
	1.7	100%	100%	100%
	2.0	100%	78%	100%

LC/3456 Terminations	1.2	100%	100%	100%
	1.6	100%	61%	100%
	1.7	100%	54%	100%
	2.0	78%	39%	78%

Overhead fiberguide layouts

FiberGuide and the Flex Exit were designed to ensure a proper fiber protection and a precise drop from the raceway system into CommScope's NG4access optical distribution frame (ODF) or other high-density frame solutions. See more information on page 35.

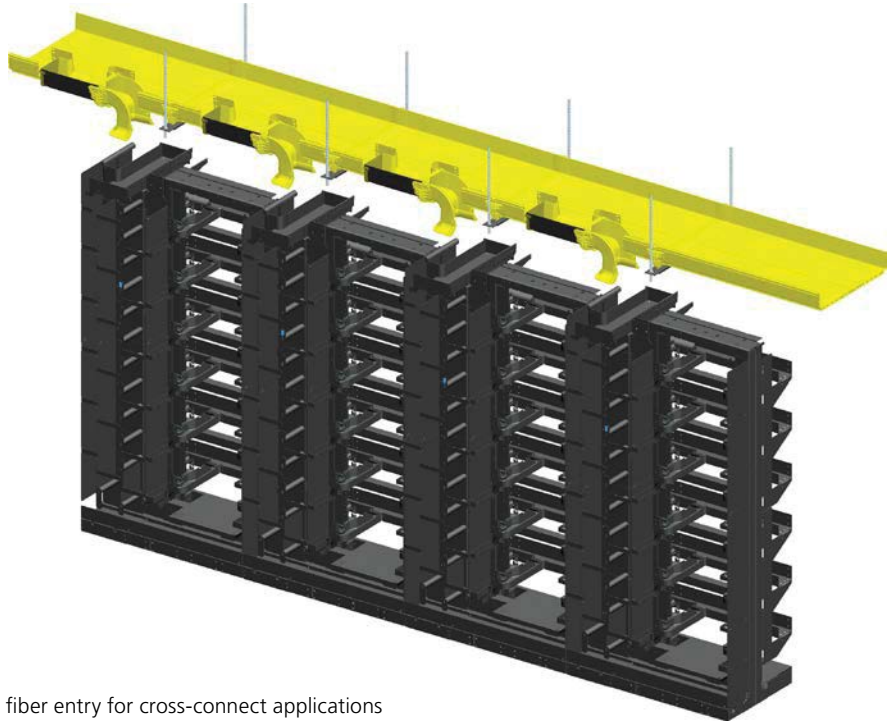

Rear fiber entry for cross-connect applications using NG4 frame with rear FOTSP

FiberGuide and the Flex Exit were designed to ensure a proper fiber protection and a precise drop from the raceway system into CommScope's NG4access optical distribution frame (ODF) or other high-density frame solutions. See more information on page 35.

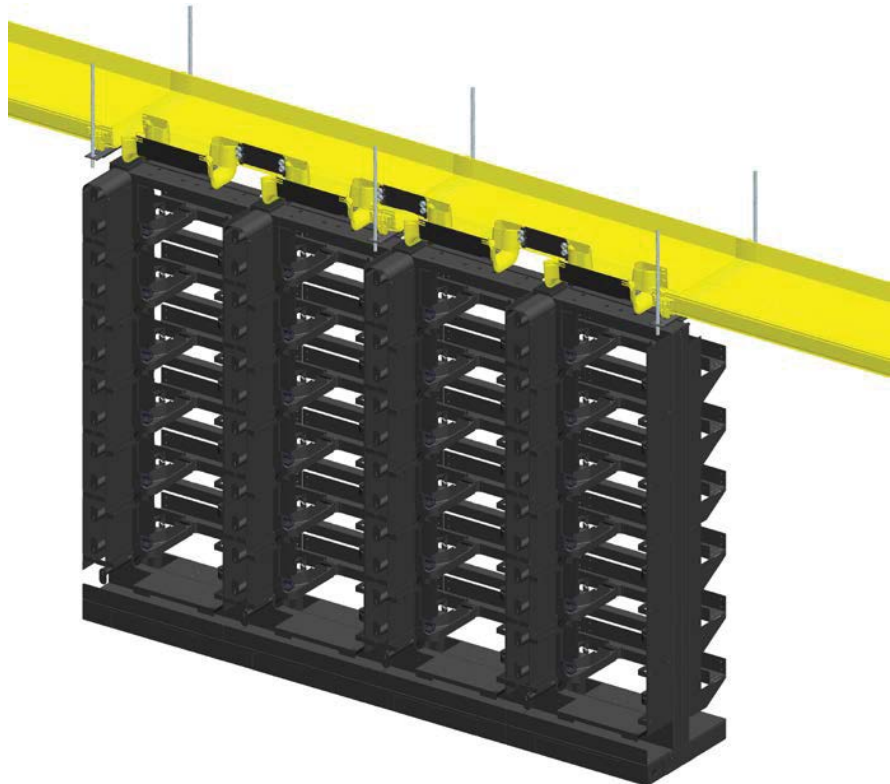

Dual front fiber entry for interconnect applications

Empty frame

The NG4access frame is the cornerstone of the NG4access ODF product line. This seismic GR-63 Zone 4 certified frame utilizes an industry-standard base frame and has six horizontal rear troughs and lower trough. This abundant trough space minimizes fiber pileup and congestion, leading to easier jumper traceability and removal. The frame has mounting positions for (6) NG4access 7-inch high chassis, which will hold up to 576 LC or 288 SC connections. On the rear of the frame, a mounting location is available for a single splice chassis without sacrificing an available chassis position for standard chassis. The vertical cable guides and slack storage system are designed to accommodate 3,456 LC terminations using 1.2 mm patch cords while maintaining a 15 mm bend radius protection at all bending locations. For additional flexibility in cable routing, the frame also includes a built-in jumper storage area on the left side. The NG4access frame meets interoperability standards covered in GR-449-CORE, Issue 3 and accommodates standard 19-inch wide frame mount equipment.



Front view



Rear view

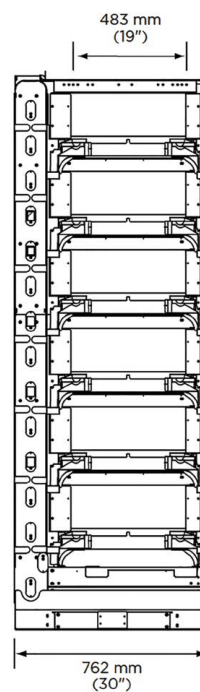

Front view

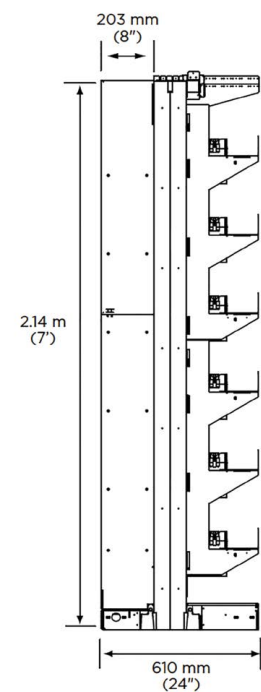

Side view

Ordering information

Description	Dimensions (H x W x D)	Max. termination capacity	Part number
Empty NG4access frame	2.14 m x 762 mm x 610 mm (7' x 30" x 24")	3,456 LC or 1728 SC terminations or per frame	NG4-FR100000

See page 11 for more information on the chassis. See page 13 for more information on the adapter packs.
See page 31 to order frame installation kits.

Rear fiberoptic terminal storage panel (FOTSP)*

The fiber optic terminal storage panel is a filler that mounts next to the NG4access frame and provides storage capacity for up to 3.6 meters (12 feet) of excess jumper slack. The panel is mounted to the right side of the frame it is serving (looking from rear of the frame) and has front and rear fiber storage.

***Not required when ordering integrated NG4access frame, NG4-FR1000A1**

Ordering information

Description	Dimensions (H x W x D)	Part number
Rear FOTSP; for use with single and dual jumpers	2.14 m x 305 mm x 610 mm (7' x 12" x 24")	NG4-ACCFOTSP

NG4 door kit

The NG4 Door Kit provides all of the materials to install doors (left and right) that provide refined aesthetics and full coverage on the front and rear of the NG4 frame.

Includes:

- Front doors (2)
- Rear doors (2)
- Support brackets, door guides and mounting brackets
- All hardware and fasteners

Ordering information

Description	Part number
NG4 Door Kit	NG4-ACCFRMDRKT2

Note: Used with Frame NG4-FR100000



Front view

Rear view

Empty frame with integrated FOTSP

For applications where a rear FOTSP will be used next to an NG4access frame, consideration should be made to order the Empty NG4access Frame with Integrated FOTSP. In this configuration, the functions of the two items are captured under a single ordering number with the added benefit of enhancing the front side cable management. Specifically, the integrated frame with FOTSP allows for larger front side vertical wireways on the slack storage interbay management panel. The rear side jumper storage wireways and slack management system are identical in size regardless of ordering the empty frame with integrated FOTSP part number or ordering the empty frame and FOTSP as separate items. The overall width (42 inches wide x 24 in deep) is also the same if ordering the integrated version or if ordering the two items separately.

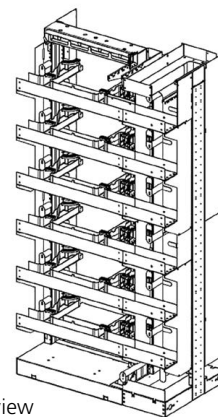

Rear view

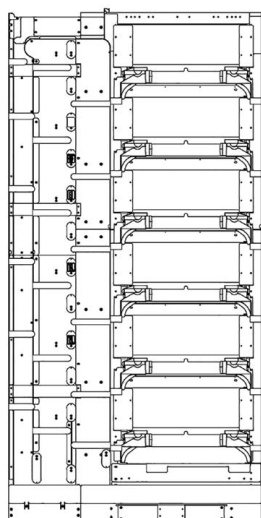

Front view

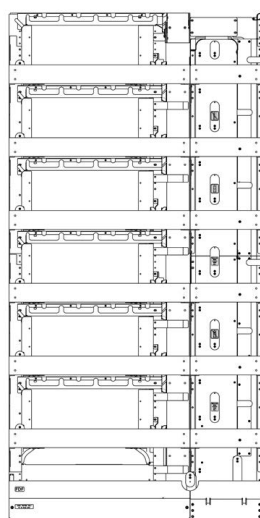

Rear view

Integrated FOTSP

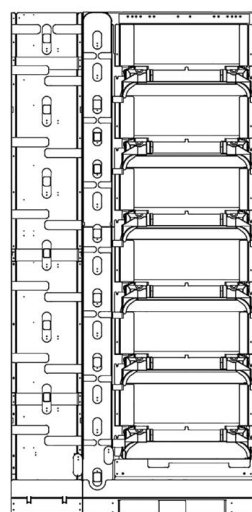

Front view

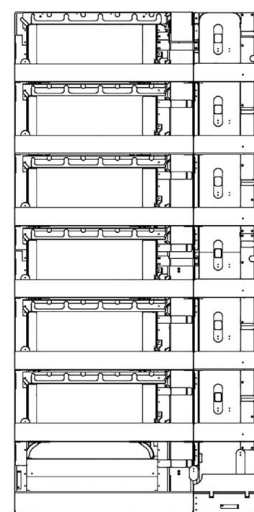

Rear view

Separate FOTSP and Frame

Ordering information

Description	Dimensions (H x W x D)	Max. termination capacity	Part number
Empty NG4access frame with integrated FOTSP	2.14 m x 1067 mm x 610 mm (7' x 42" x 24")	3,456 LC or 1,728 SC terminations per frame	NG4-FR1000A1

* Does not work with FOTSP

NG4 door kit

The NG4 Door Kit provides all of the materials to install doors (left and right) that provide refined aesthetics and full coverage on the front and rear of the NG4 frame.

Includes:

- Front doors (2)
- Rear doors (2)
- Support brackets, door guides and mounting brackets
- All hardware and fasteners

Description	Part Number
NG4 Door Kit	NG4-ACCIFRMDRKT1

Note: Used with Frame NG4-FR1000A1

Equipment frame

The NG4 Equipment Frame allows mounting of standard 23" active equipment in the same form factor as standard NG4 frames, providing seamless alignment through rear troughs and cable pathways.

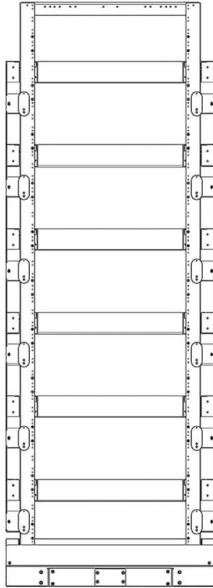

Front view

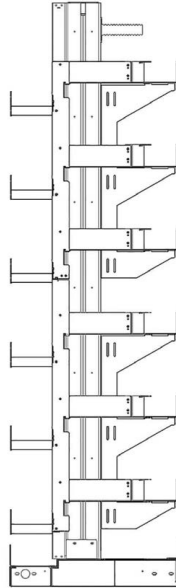

Side view

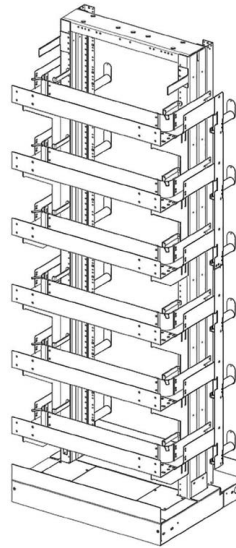

Front view

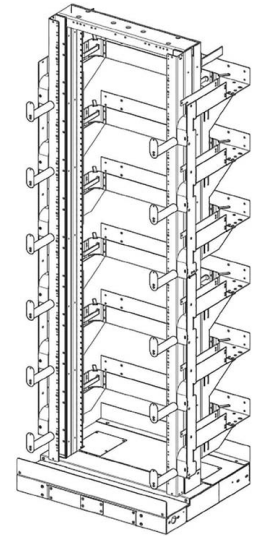

Rear view

Ordering information

Description	Dimensions (H x W x D)	Max. termination capacity	Part number
NG4access Equipment Frame	2.14m x 762 mm x 610 mm (7' x 30" x 24")	76 1.00" WECO 23" Mounting Spaces	NG4-FR1EQ001

Universal chassis

The 7" universal chassis will hold up to 576 LC or 288 SC terminations. Each chassis includes 24 access trays. A single access tray can hold (2) LC12 or SC6 adapter packs, or a cabled module, MPO module or VAM module, any of which can be mixed and matched in the same chassis. Designed for easy technician access, the chassis features the same user interface on the front and back side of unit. During service turn-up and maintenance, the access trays pull open and lock in place for easy access to connectors. Pivot points on the access trays prevent the fiber from moving when opening and closing trays, which helps prevent any unwanted disturbances to live services. A front door with a circuit designation booklet ships with every chassis. The chassis will install in a 19" standard equipment rack and occupies (4) 1.75" rack spaces.

Ordering information

Description	Dimensions (H x W x D)	Part number
Universal chassis with access trays; front door and designation cards	483 x 457 x 175 mm (19" x 18" x 6.9")	NG4-CH100000



Front chassis view



Front chassis view
door open



Front chassis view
access tray open



Access trays with (2) LC 12 and (2) SC 6 adapter packs installed

E-series chassis

The 7" (4RU) E-Series chassis is a cost-efficient option for NG4 deployment.

- Holds up to 576 LC or 288 SC terminations in 24 access trays.
- A single access tray can hold
 - (2) LC12 adapter packs
 - (2) SC6 adapter packs
 - (1) cabled module, MPO module or VAM module
- Modules may be mixed and matched in the same chassis.
- Installs in NG4 frames or standard 19" racks
- Non GR and Seismic rated
- Front doors may be ordered separately

Ordering information

Description	Dimensions (H x W x D)	Part number
E- Series chassis with access trays	483 x 457 x 175 mm (19" x 18" x 6.9")	NG4-CH100000-E



Chassis

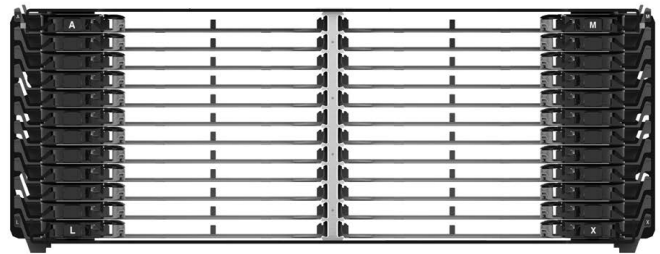

Front chassis view

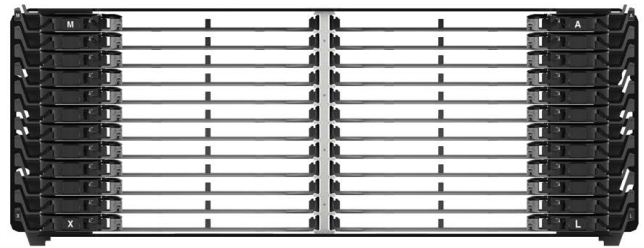

Back chassis view

8-Inch FCM Optical Distribution Frame Fiber Termination Panel Featuring NG4 CMOD's

The addition of the 8-inch FCM ODF Fiber Termination Panel updates the FDF style chassis with a higher density NG4 quick termination cable using CMODs for plug-and-play installation.

- Designed to be mounted in an FDF rear load frame equipped with cable management hardware.
- Holds up to 288 LC or 144 SC terminations (12 CMODs).
- Each panel opening cabled module, MPO module, or VAM module will fit in each opening with tray adapter insert.
- Modules may be mixed and matched in the same chassis.
- Rear cable management addressed cable management.

Ordering information

Description	Dimensions (H x W x D)	Part number
FCM-100000-CMOD: FCM 288 C-MOD EMPTY PANEL	584 x 305 x 203 mm (23" X 12" X 8")	760245372



FCM-10000-CMOD
(Front)



FCM-10000-CMOD
(Rear)

9-Inch LSX Optical Distribution Frame Fiber Termination Panel Featuring NG4 CMOD's

The 9-inch LSX ODF Fiber Termination Panel updates the LGX style chassis using a higher density NG4 quick termination cable and CMODs for plug-and-play installation.

- Designed to be mounted in a 19" or 23" frame.
- Up to 288 LC or 144 SC terminations (12 CMODs).
- Each panel opening fits a cabled module, MPO module, or VAM module with tray adapter insert.
- Modules may be mixed and matched in the same chassis.
- Rear cable management addressed cable management.



LSX-70000-CMOD
(Front)

Ordering information

Description	Dimensions (H x W x D)	Part number
LSX 288 C-MOD EMPTY PANEL	483/584 x 280 x 229 mm (19/23" X 11" X 9")	LSX-700000-CMOD



LSX-70000-CMOD
(Rear)

5-Inch LSX Optical Distribution Frame Fiber Termination Panel Featuring NG4 CMOD's

The 5-inch LSX ODF Fiber Termination Panel updates the LGX style chassis using a higher density NG4 quick termination cable and CMODs for plug-and-play installation.

- Designed to be mounted in a 19" or 23" frame.
- Up to 144 LC or 72 SC terminations (6 CMODs).
- Each panel opening fits a cabled module, MPO module, or VAM module with tray adapter insert.
- Modules may be mixed and matched in the same chassis.
- Rear cable management addressed cable management.



LSX-300000-CMOD
(Front)

Ordering information

Description	Dimensions (H x W x D)	Part number
LSX 144 C-MOD EMPTY PANEL	483/584 x 280 x 127 mm (19/23" X 11" X 5")	LSX-300000-CMOD



LSX-300000-CMOD
(Rear)

NG4access Optical Distribution Frame Solutions (2RU NG4 Chassis)

The NG4 chassis is also available for non-NG4 frame application, such as equipment frame and 2 post rack installations. The smaller 2 RU version making it ideal for equipment frame installations where the higher capacity 4 RU chassis may provide more density than what's needed.

The 2 RU chassis includes 12 access trays, holds up to 288 LC connectors, and also supports MPO and cabled modules.



NG4 2 RU Chassis
For Non-NG4 Application Installations
(NG4-CH100000-2B)

Ordering information

Description	Rack Units	Dimensions (H x W x D)	Part number
Universal Chassis, Empty With access trays, front door and designation cards	2	3.82" x 17.44" x 19.48" (97.0 x 442.98 x 494.80 mm)	NG4-CH100000-2B (760242618)

Universal adapter packs

Adapter packs are designed to accept a variety of connector types, including singlemode and multimode, angled and ultra polished connections. The flexibility of the adapter pack helps service providers reduce ordering SKU's and total inventory requirements. The staggered adapter pack design help installers access connectors without pinching or moving adjacent connections; they also eliminate the need for installers to use extraction tools, and help clearly identify individual fiber ports. Two LC12 or SC6 adapter packs can be installed per tray, and up to 48 total adapter packs per chassis. A specially designed latch window on the rear of the LC adapter pack (see photo below) and key slot window on the SC adapter pack allow easy identification of the connector type on the opposite side of the unit. As a result, technicians will always know the connector type installed in the adapter, no matter if they are working from the front or rear side of the ODF.

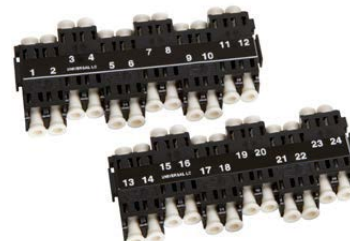

LC12 Universal adapter packs

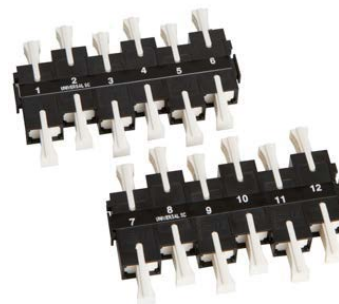

SC6 Universal adapter packs

Ordering information

Description	Fibers	Dimensions (H x W x D)	Part number
Snap-in LC12 universal adapter pack. Kit of 2 packs with labels.	24	84 x 33 x 10 mm (3.3" x 1.3" x .4")	NG4-APLC120000
Snap-in SC6 universal adapter pack. Kit of 2 packs with labels.	12		NG4-APSC060000
Snap-in MPO universal adapter pack. Kit of 2 packs with labels. (Method A Polarity)	8 MPOs		NG4-APMP040000



NG4 MPO Adapter packs

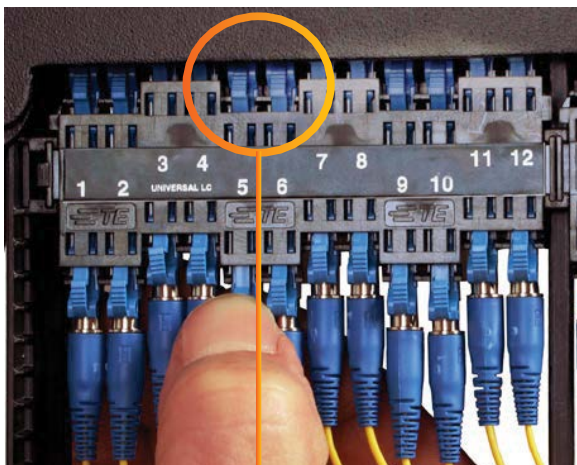

Latch window on LC adapter pack allows for easy connector identification

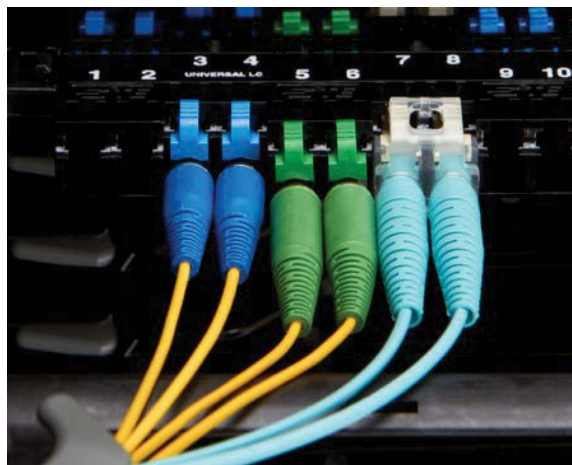

Adapter packs accept a variety of connector types

Preterminated cable modules

NG4access cabled modules will save operators significant time and cost in their cable deployments. Using the LC cabled module, for example, an installer can route a 24-fiber cable to any access tray in a universal chassis, then rapidly terminate the module's 24-fiber connectors using a single click, rather than installing 24 individual connectors. Cabled modules are available in LC and SC, singlemode configurations. Each module is designed for craft friendliness. Individual adapter ports are labeled for easy identification. Two cable options are available with cabled modules, conventional IFC or 24-fiber microcable IFC cable.



LC Cabled Module with Preterminated IFC



LC Cabled module with 24-fiber microcable

Cabled modules with preterminated IFC

With IFC cabled module solutions, multiple cabled modules are preterminated to IFC cable. For example, a 144 LC configuration would include six 24-fiber cabled modules secured to a 144 IFC cable. Rather than handling and installing 144 discrete connectors, the six cabled modules quickly snap into place on the access tray saving installation time and greatly reducing wiring errors and the potential for breaking adjacent fiber connectors. IFC cabled modules are available with stub ends or with connectors or cabled modules on the far end. All IFC cabled modules utilize reduced bend radius fiber and have the appropriate break out length to be installed in any access tray on any chassis in the frame. IFC cabled modules ordered with far end connectors can be used as tie cables to existing legacy ODF's. The far end breakouts for these assemblies are designated by the last three digits in the ordering configurations. All IFC cabled modules ship with the cable clamp required on the NG4access frame and at the far end if required for double ended assemblies.

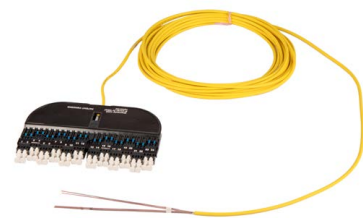

LC cabled module with preterminated IFC

Cabled modules with preterminated IFC (continued)

Ordering information



Cabled module connector type #1

Singlemode	
K	LC ultra polish
M	LC angled polish
7	SC ultra polish
L	SC angled polish

Far end connector type #2*

Singlemode	
0	No connector/stub end
K	LC ultra polish
M	LC angled polish
7	SC ultra polish
L	SC angled polish
N	Cabled Module**

Far end breakout style

If not a stub or cabled module, enter an option from below.

Blank	Stub or cabled module
NG3	NG3 72 and 144 position panel
NG	NGF 96 and 144-position FTB
NO	NGF 48 and 72-position FTB
A	7" FCM
B	8" FCM
LA	LSX 72 and 96-position panel
LB	LSX 144-position panel

Standard cable length***

016	16 m (50')
023	23 m (75')
031	31 m (100')
046	46 m (150')
061	61 m (200')
092	92 m (300')

Cable type

		Diameter	
		mm	"
GQ	72 Loose tube stranded IFC	11.9 mm	.47"
KQ	96 Loose tube stranded IFC	13.7 mm	.54"
HQ	144 Loose tube stranded IFC	17.7 mm	.70"
GL	72 Loose tube Stranded Indoor/Outdoor	11.9 mm	.47"
KL	96 Loose tube Stranded Indoor/Outdoor	13.7 mm	.54"
HL	144 Loose tube Stranded Indoor/Outdoor	17.7 mm	.70"

* Far end connector option only available with stranded cable

** Far end cabled module connector type is always same as type #1 connector type

*** Use XXX for non-standard lengths in meters

Cabled modules with rollable ribbon indoor/outdoor jacketing

Cabled modules with Rollable Ribbon Indoor/Outdoor Jacketing

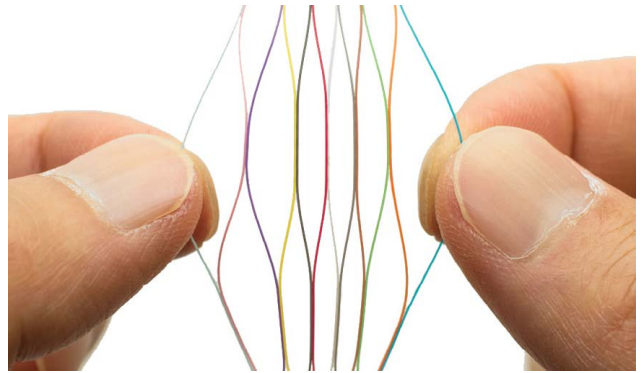
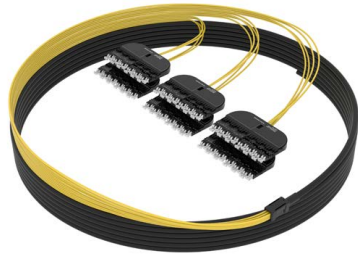

Rollable Ribbon Cable

Ordering information

NG4 - CMD

Cabled module connector type #1

Singlemode	
K	LC ultra polish
M	LC angled polish

Far end connector type #2*

Singlemode	
0	No connector/stub end

Cable type

	Number of Fibers	Outer Diameter	
RG	72	10.5 mm	.41"
RK	96	10.5 mm	.41"
R3	144	10.5 mm	.41"
RJ	216	12.5 mm	.49"
R4	288	12.5 mm	.49"
R5	432	15.5 mm	.61"
R6	576	17.0 mm	.67"
R8	864	19.5 mm	.77"

Standard cable length***

016	16 m (50')
023	23 m (75')
031	31 m (100')
046	46 m (150')
061	61 m (200')
092	92 m (300')
122	122 m (400')
138	138 m (450')
153	153 m (500')
183	183 m (600')
305	305 m (1000')

***Use XXX for non-standard lengths in meters
76" breakout on LC end

Cabled modules with 24-fiber microcable

For LC configurations, a single cabled module is connected to a 24-fiber microcable. For SC configurations, two cabled modules are connected to a 24-fiber microcable. The 24-fiber microcable is a plenum rated dual zip-cable containing reduced bend radius 250 micron fiber in a loose tube design. The 24-fiber microcable has the same compression, tensile strength and crush rating as conventional IFC cable and is fully compliant with GR-409. It can be secured to overhead cable racking or is flexible to be placed in FiberGuide or any fiber cable management system. Cabled modules are available with a stub end or with connectors on the far end. The breakout length for 24 fiber microcable IFC with far end connectors is 45 inches. This breakout length will accommodate all legacy CommScope ODF solutions however, a fanout mounting bracket kit must be ordered separately to match the far end clamping requirements.



Two SC cabled modules with 24-fiber microcable
2 modules stacked for photo

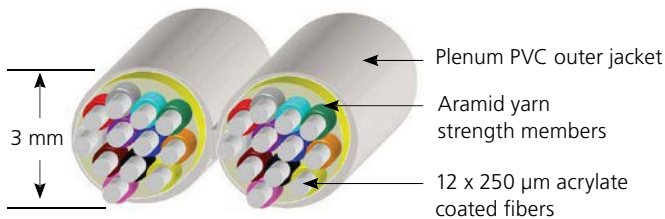

Ordering information

NG4 - CMD M2

Cabled module connector type #1

Singlemode	
K	LC ultra polish
M	LC angled polish
7	SC ultra polish
L	SC angled polish

Far end connector type #2

Singlemode	
0	No connector/stub end
K	LC ultra polish****
M	LC angled polish****
7	SC ultra polish****
L	SC angled polish****
N	Cabled Module**
E	MPO Connector

Standard cable length***

016	16 m (50')
023	23 m (75')
031	31 m (100')
046	46 m (150')
061	61 m (200')

Cable type

M2	24-fiber microcable
----	---------------------

** Far end cabled module connector type is always same as type #1 connector type

*** Use XXX for non-standard lengths in meters

**** Far End Fanout 900um upjacketing.

Contact CommScope's Technical Assistance Center for availability of other upjacketing options.

Cabled modules with 24-fiber rollable ribbon cable

For LC configurations, a single cabled module is connected to a 24-fiber Rollable ribbon. The 24-fiber rollable ribbon is a plenum rated cable containing reduced bend radius 250 micron rollable fiber in a loose tube design.

The 24-fiber cable is flexible enough to be placed in FiberGuide or any fiber cable management system. Cabled modules with rollable ribbon are available with a stub end.

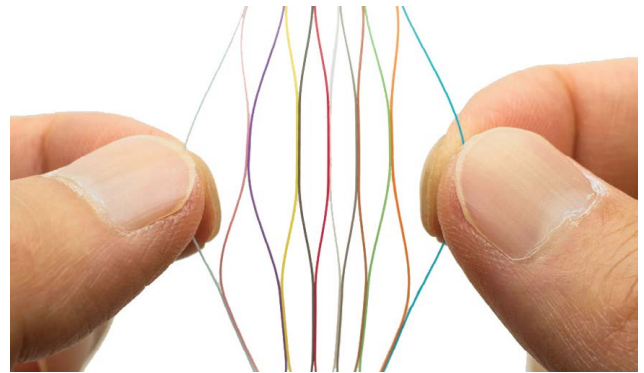
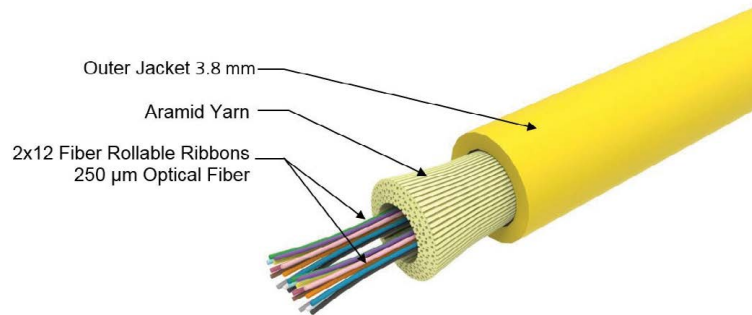

Rollable Ribbon Cable

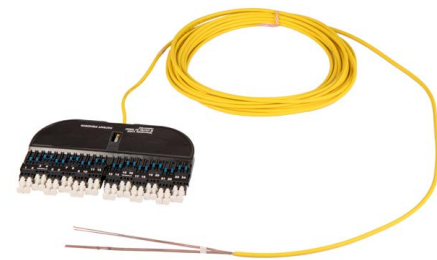

Ordering information

NG4 - CMD R2

Cabled module connector type #1

Singlemode	
K	LC ultra polish
M	LC angled polish

Far end connector type #2

Singlemode	
0	No connector/stub end

Standard cable length***

016	16 m (50')
023	23 m (75')
031	31 m (100')
046	46 m (150')
061	61 m (200')

Cable type

R2	24-fiber rollable ribbon
----	--------------------------

*** Use XXX for non-standard lengths in meters
Contact CommScope's Technical Assistance Center for availability of other upjacketing options.

Microcable fanout mounting bracket kits

Microcable fanout mounting bracket kits for 45" 900 micron breakouts

Additional hardware is required if loading cabled modules with 24- fiber microcables with far end connectors into an adapter-only legacy ODF panel. Microcable fanout mounting brackets convert adapter-only panels to accept preterminated microcables with 900 micron breakouts. The bracket kits contain the cable management hardware, brackets and cable clamps to convert the panel to accept microcables and properly secure fanouts.

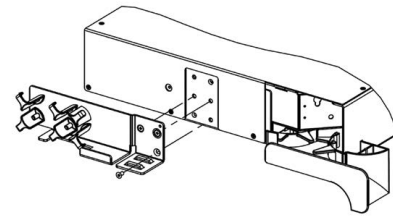

NG3 Panel bracket kit

Ordering information

	Description	Part number
Microcable Fanout Kits	7" FCM panels	RCP-CLPKITSBFCM
	8" FCM panels	RCP-CLPKITFCM
	LSX panels (all sizes)	RCP-CLPKITLSX
	NGF Left 144 FTB	NGF-ACCRCMSLU
	NGF Right 144 FTB	NGF-ACCRCMSRU
	NG3 panel	RCP-CLPKITNG3



NG3 Fanout Bracket

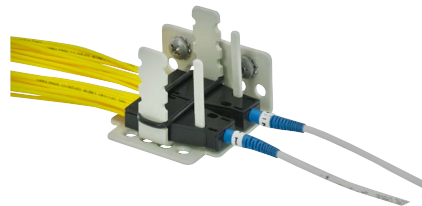

LSX Fanout Bracket

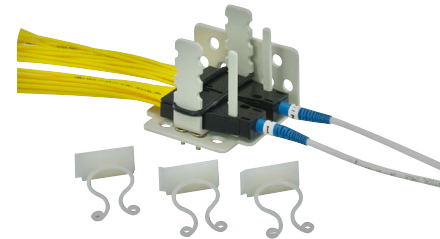

FDF Fanout Bracket

MPO modules

The MPO module offers a craft-friendly interface for 24 LC or 12 SC connectors to MPO adapters—enabling a rapid connection to electronics or a fiber tie panel such as CommScope’s Rapid fiber panel solution. Leveraging an MPO architecture, technicians can route and install higher fiber counts faster and easier, while simplifying cable inventory and ordering requirements. The MPO module occupies one access tray position and easily snaps into place.

Unless noted modules employ Method A (straight) polarity.



Left Exit LC MPO Module with 2 rear MPO Adapters



Right exit SC MPO module with 1 rear MPO adapter

Ordering information

NG4 - MMD 000

Cabled module connector type #1

Singlemode	
K	LC ultra polish
M	LC angled polish
7	SC ultra polish
L	SC angled polish
Multimode	
C	LC
T	SC

Cabled module connector type #2

Singlemode	
E	MPO 12 fiber
Multimode	
M	MPO Elite 12 fiber OM4

Exit direction

0L	Left exit (for MPO module)
0R	Right exit (for MPO module)

Order right exit MPO modules for access trays on this side of chassis

Order left exit MPO modules for access trays on this side of chassis



Universal chassis rear view

Value-added modules

The NG4access Value-Added Modules (VAMs) product family features an array of monitor, CWDM and DWDM devices for use in CommScope's NG4access optical distribution frame (ODF). NG4access VAMs help enhance optical transport systems by providing flexible, easy to incorporate optical components into the network for increasing fiber capacity, troubleshooting, or distributing signals to multiple subscribers.

Technician-friendly, the NG4access VAMs features staggered adapter ports for easy connector access and identification without pinching or moving adjacent connections – minimizing unwanted disturbances to live services. Craft-friendly module design promotes easy integration into CommScope's NG4access ODF: one NG4access VAM can be loaded per tray, with up to 24 total VAMs per chassis. The VAMs are available in 24 LC connector interfaces with angled and ultra polished configurations.

Module types

- Monitor VAMs
- Splitter VAMs
- CWDM VAMs
- DWDM VAMs

Applications

- Non-intrusive circuit monitoring
- Service turn-up verification and troubleshooting
- CWDM/DWDM upgrades for metro networks
- CWDM/DWDM upgrades for wireless backhaul



NG4access VAM



NG4access ODF platform
(sold separately)

Splitter VAMS

Splitter VAMs are used to split (or combine) optical signal power from one fiber to multiple fibers. NG4access VAM splitters can be used for signal distribution in PON networks or for redundant path route protection. NG4access splitter VAMs occupy up to three access trays in the universal chassis and snap easily into place.

Ordering information

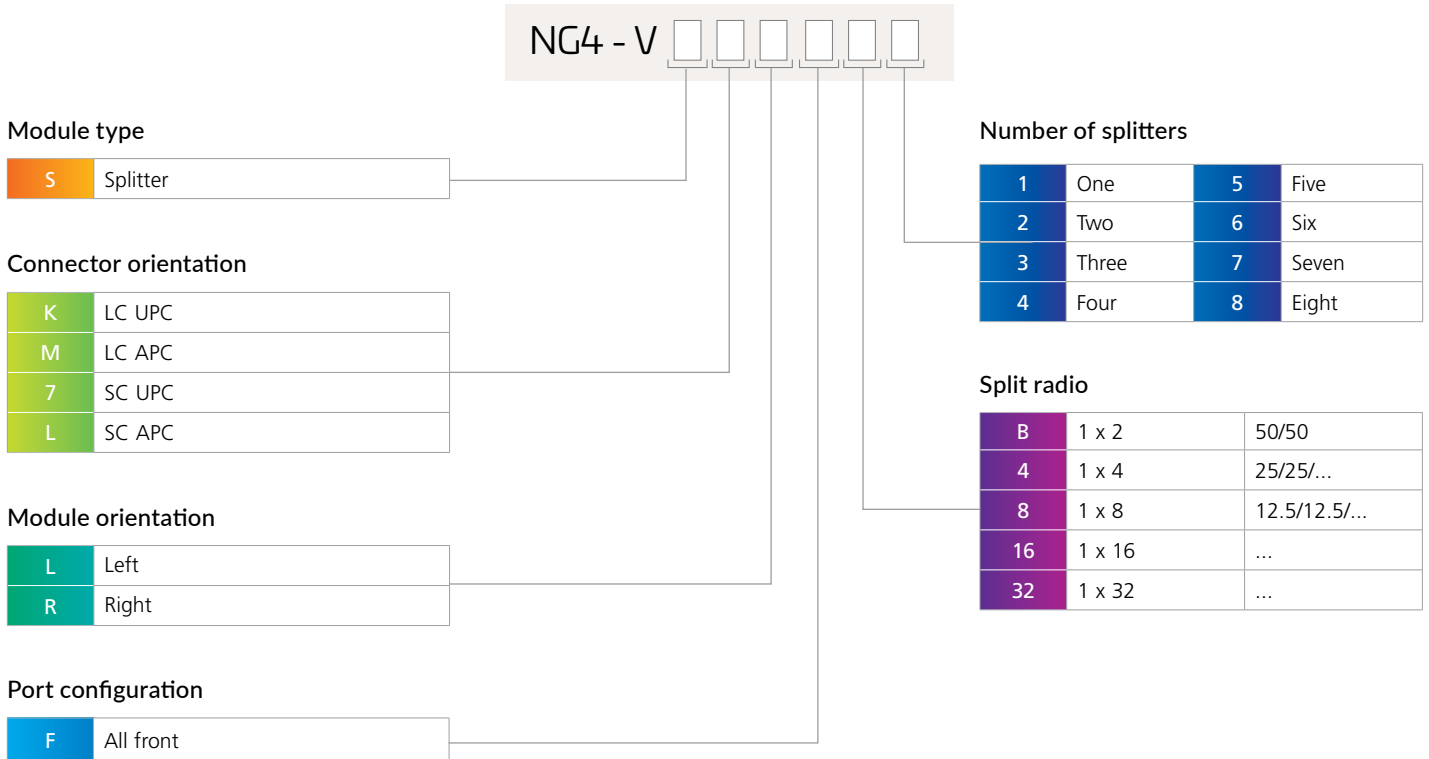

Example shown:

NG4-VSMLF132 (NG4access VAM Splitter, LC APC, left orientation, all front ports, one splitter, 1x32 split ratio)

Note: Most splitter modules will occupy one tray in the NG4 universal chassis. 1x32 splitters will occupy three trays.



Single high NG4access VAM



Triple high NG4access VAM

Singlemode monitor VAMs

Singlemode Monitor VAMs are used for non-intrusive monitoring and testing of fiber optic network signals. VAM modules provide a wide range of tap ratios to accommodate specific application requirements.

The ability to easily monitor both directions at a single point greatly reduces the time necessary to analyze traffic patterns, locate failures, and monitor signal degradation. NG4access Monitor VAMs occupy one access tray in the universal chassis and easily snap into place. The NG4access universal chassis holds up to 12 left and 12 right orientation VAMs.

Ordering information

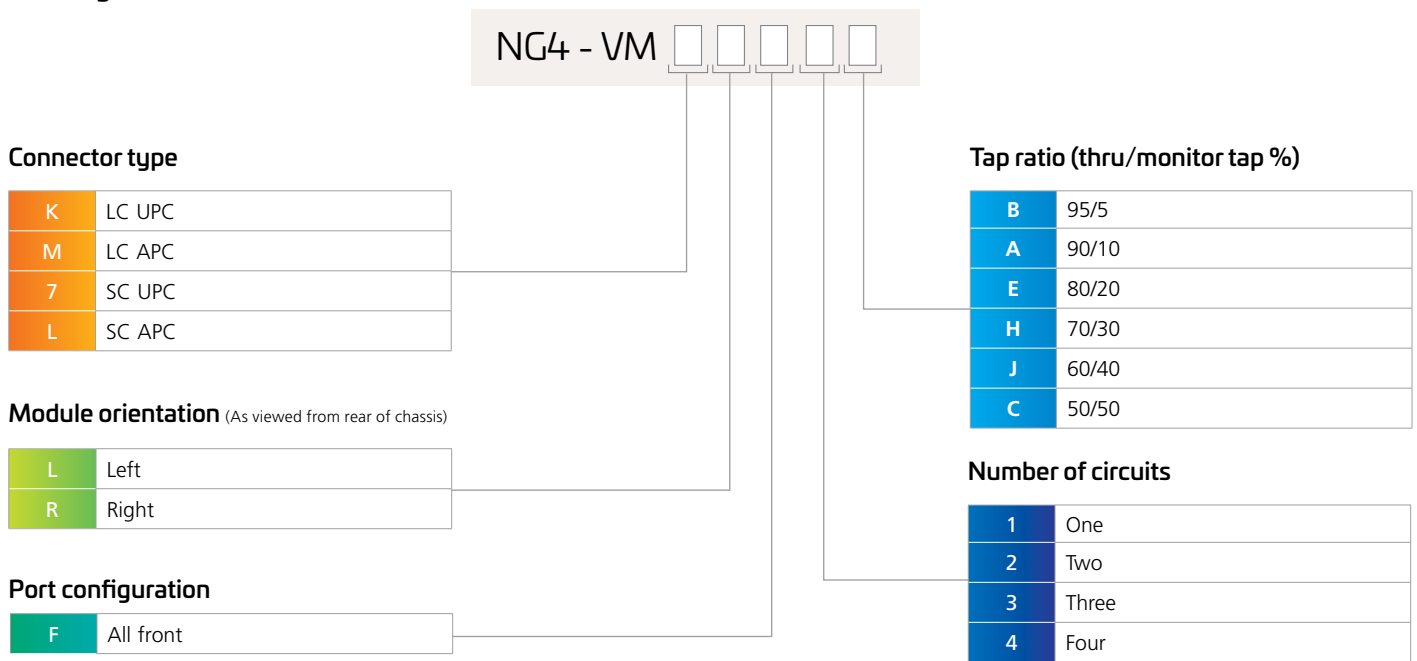

Example shown:

NG4-VMMLF4A (NG4access VAM monitor, LC UPC, left orientation, all front ports, four circuits, 90/10 tap ratio)



All front port configuration

Multimode monitor VAMs

Multimode Monitor VAMs are used for non-intrusive monitoring and testing of fiber optic network signals. VAM modules provide a wide range of tap ratios to accommodate specific application requirements.

The ability to easily monitor both directions at a single point greatly reduces the time necessary to analyze traffic patterns, locate failures, and monitor signal degradation. NG4access Monitor VAMs occupy one access tray in the universal chassis and easily snap into place. The NG4access universal chassis holds up to 12 left and 12 right orientation VAMs. Multimode Monitor VAMs work at data rates of 10Gbps and lower.

Ordering information

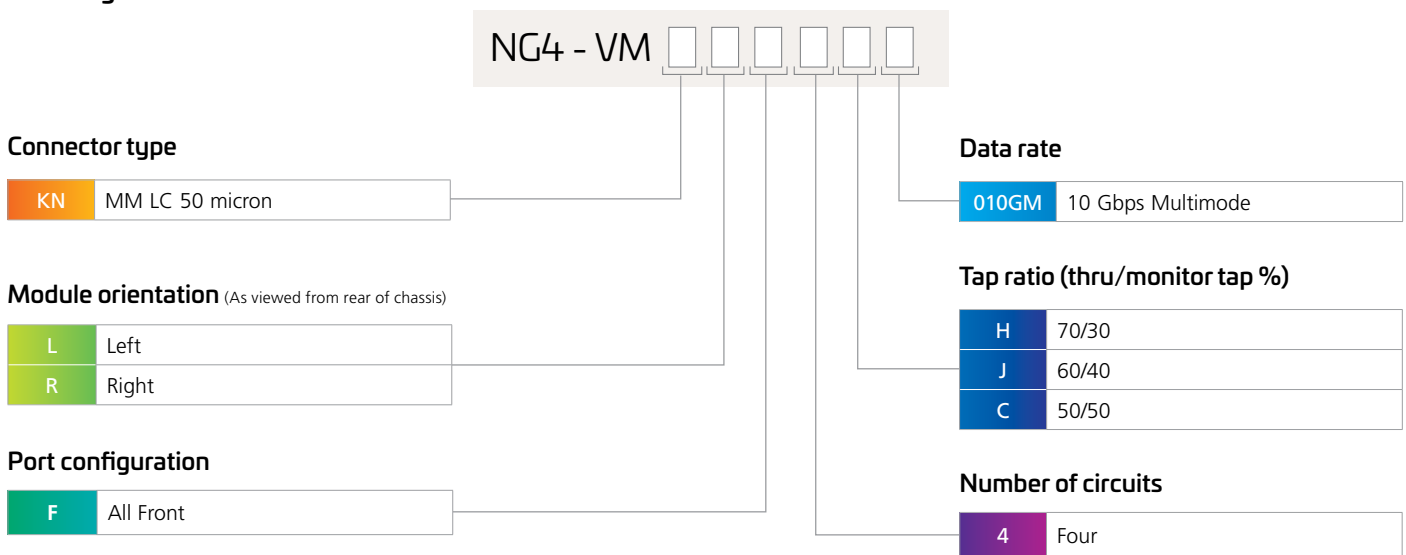

All front port configuration

CWDM & DWDM VAMs

Coarse Wavelength Division Multiplexing (CWDM) and Dense Wavelength Division Multiplexing (DWDM) VAMs are used to combine (or separate) two or more signals with different wavelengths.

CWDM VAM modules provide a wide range of wavelength combinations from 4 to 8 channels while DWDM VAM modules are typically used for higher channel count requirements and combine 8 to 40 channels based on the ITU DWDM wavelengths.

Both CWDM and DWDM modules are available with up to 12 SC or 24 LC front facing connectors. Test ports are available for signal turn-up and test access. NG4access CWDM VAMs occupy one access tray in the universal chassis. NG4access DWDM VAMs occupy either one, two or three access trays in the universal chassis. The NG4access universal chassis holds up to 12 left and 12 right orientation single high VAMs. Which easily snap into place.

For details please contact your account manager or field application engineer in regards to [available configurations](#).



Single high NG4access VAM



Double high NG4access VAM



Triple high NG4access VAM

Splice chassis

The splice chassis installs on the back side of the NG4access frame below the bottom horizontal trough and holds up to 48 splice trays. The single fusion splice tray has a maximum capacity of 24 fibers for 1152 fiber maximum capacity per chassis. The ribbon splice tray has a maximum capacity of 72 fibers for 3456 fiber maximum capacity per chassis. Pigtail 24-fiber microcable cabled modules connect any universal chassis to the splice chassis.

Ordering information

Description	Dimensions	Part number
Splice chassis; empty	686 x 314 x 406 mm (27" x 12.36" x 15.99")	NG4-CH200000

Individual splice trays not included.



Splice chassis installed at bottom of frame (rear cover removed)

Splice tray

Splice tray holds up to six mass fusion protection sleeves for 72-fiber capacity or up to 24 single fusion protection sleeves. Each tray provides for storage of 6 feet of jacketed cable and an additional 3 feet of unjacketed fiber inside the tray.

Ordering information

Description	Dimensions	Splice Chip	Part number
Splice tray	148 x 191 x 19 mm (5.83" x 7.53" x .745")	single fusion	NG4-ACCWHSFS
		mass fusion	NG4-ACCWHMFS



Pigtail not included

Pigtail cabled module with 24-fiber microcable

Pigtail cabled modules can be installed in any of the 6 universal chassis loaded in a frame and can be routed to the splice chassis to reach the splice tray with appropriate storage.

Ordering information

Description	Dimensions	Part number
24-fiber pigtail* cabled module	LC ultra polish connectors	NG4-CMDK0M2008
	LC angled polish connectors	NG4-CMDM0M2008
	SC ultra polish connectors	NG4-CMD70M2008
	SC angled polish connectors	NG4-CMDL0M2008

* Stranded microcable construction. When splicing to ribbon IFC/OSP cable, microcable fiber will need to be ribbonized



LC pigtail cabled module

Pigtailed cable modules with 24-fiber rollable ribbon cable

Rollable ribbon pigtail cabled modules can be installed in any of the 6 universal chassis loaded in a frame and can be routed to the splice chassis to reach the splice tray with appropriate storage.

Ordering information

Description	Dimensions	Part number
24-fiber Rollable ribbon pigtail cabled module	LC ultra polish connectors	NG4-CMDK0R2008
	LC angled polish connectors	NG4-CMDM0R2008

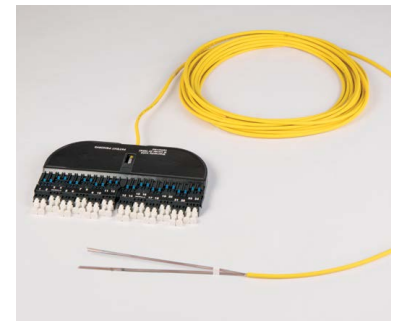

Rollable ribbon pigtail cabled module

Splice protections sleeves

The splice protector sleeve is constructed to protect a splice post fusion. It is made from heat shrinkable material and contains a built-in strength member for physical protection of the fusion splice. The splice protector sleeve is placed on the fiber before making a splice, moved over the splice when the splice fusion is complete and shrunk into place. They are available in either single fiber or mass fusion sleeves.



Splice protector sleeve

Ordering information

Description	Dimensions	Part Number
Splice protector sleeve for	Single fiber–single fusion; 40 mm (1.6") length, 1 each	FST-ACC005
	12-fiber–mass fusion–heat shrink; 40 mm (1.6") length, 1 each	FST-ACC006

Cable clamp kits

Ordering information

Description	Part number
Cable clamp kit; Includes clamps and grommets for securing 6 OSP or IFC cables with diameters up to 0.8 inches at the top of the frame*	NG4-ACCCLMPEXP1
Large cable clamp kit; Includes clamps and grommets for securing 4 OSP or IFC cables with diameters from 0.8 inches to 1.2 inches at the top of the frame*	NG4-ACCCLMPEXP2

* CommScope preterminated IFC cabled modules include a cable clamp

Raised floor cable entry clamp kit

Ordering information

Description	Part number
Raised floor cable entry clamp kit; Includes mounting brackets, a management spool and clamps and grommets for 24 cables (diameter up to 0.8 inches)	NG4-ACCRFCLMP1
Raised floor large cable clamp kit; Includes one cable clamp and grommet for cables with diameters from 0.8 inches to 1.2 inches. This clamp kit mounts to the raised floor cable entry clamp mounting bracket	NG4-ACCRFCLMP3
Raised floor IFC slack management kit; spool kit for managing IFC sub-unit slack. Kit includes one spool.	NG4-ACCSPoolKIT1

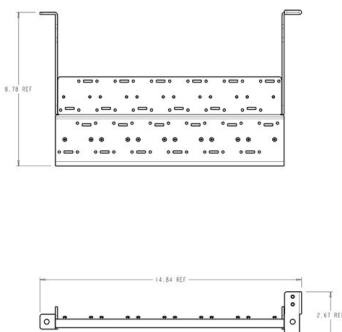

NG4-ACCRFCLMP1

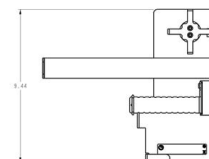
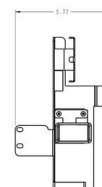
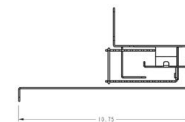
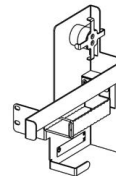
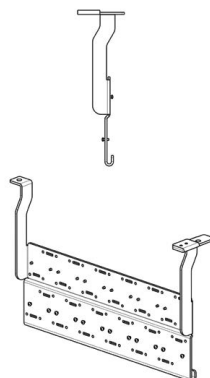

NG4-ACCSPoolKIT1

Mesh breakout kits

Mesh Breakout Kits create a simple and craft friendly installation with a significant reduction in time compared to plastic, transportation tube style breakout kits.

- Supports both standard matrix style ribbon and pliable ribbon fibers.
- Allows for easier routing with reduced congestion.
- Lower cost versus plastic transportation tube style breakout kits.

Ordering information

Material ID	Part Number	Description
760244143	RIBCBOU-1/4-35-144	Use for all ribbon applications

Note: To calculate number of kits required, divide number of fibers in cable by 72. Divide that number by three and round up to whole number. Example - $1152f/72f=16$; $16/3=5.3$ or 6 kits per 1152f cable

Fiber Count	Number of Kits Needed
288f	2 Kits
432f	2 Kits
864f	4 Kits
1152f	6 Kits
1728f	8 Kits
3456f	16 Kits

Accessories

Material ID	Description
NG4-SNKT-BULK	Snap-in Cable Retention Rings (Qty. 40)
NG4-SPCAB-MTBKT	Optional External Trunk Mounting Bracket
NG4-CBOU-288	Breakout kit 288 fiber cable
NG4-CBOU-1728	Kit of 6 - 288 fiber breakouts
NG4-CBOU-BULK	Kit of 24 - 288 fiber breakouts



Ribbon Breakout kits contain combinations of bases and protective tubes that are used to protect the fiber ribbon matrix as it transitions from clamped OSP and IFC cables to a splice tray used in the NG4access splice chassis.

Breakout kit for ribbon in loose buffer tube (RLBT) OSP cable

Ribbon in loose buffer tube OSP cables are constructed as shown in Figure 1. All RLBT cables feature six subunits surrounding a central strength member. Depending on the fiber count of the cable, some of the subunits may be used as filler subunits (a solid plastic unit without any fiber). Each subunit containing fiber is comprised of six or twelve ribbons featuring 12 fibers per ribbon.

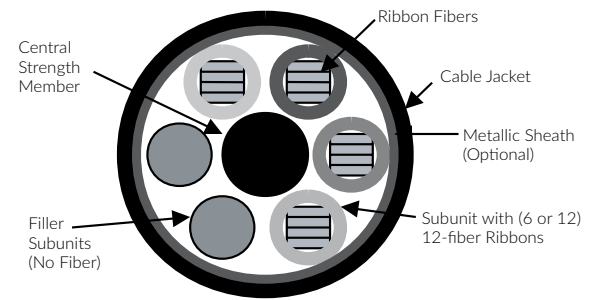

Figure 1
Ribbon buffer tube (RLBT) OSP cable

Breakout kits for RLBT cables contain multiple breakout bases, each with 5-meter lengths of protective tubing (see Figure 2). The protective tubing accommodates up to six ribbons. One breakout kit fits into each individual subunit. For mass fusion ribbon splicing applications, CommScope recommends splicing up to 72 fibers (six ribbons) in a splice tray. The tray should be equipped with an “MT” splice chip (see page 93 for information on mechanical or mass fusion ribbon trays). For single fusion splicing applications, CommScope recommends 24 fibers per tray using either two single trays or one dual tray. This kit is used to protect fiber ribbons between the cable clamp and the splice tray.

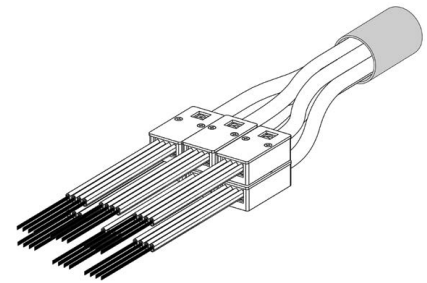

Figure 2
Breakout kit for RLBT OSP cable

Breakout kits are designed for use in controlled environments only.

Ordering information

BLK - RLBT - A 0

Number of protective tubes per subunit¹

01	One
02	Two
03	Three
04	Four
05	Five
06	Six

Number of subunits containing fiber

01	One
02	Two
03	Three
04	Four
05	Five
06	Six

1-6 ribbons may be placed in each protective tube
Protective tubing length = 5 meters

¹ The number of protective tubes per subunit is calculated as follows:

Divide the number of fibers per subunit (typically 72 or 144) by the number of fibers (12, 24, 36, 48, 72) to be spliced in each splice tray.
Example: If each subunit has 144 fibers with 36 fibers per tray, then each subunit would require four protective tubes.

Breakout kit for ribbon central tube (RCT) OSP cable

Ribbon central tube OSP cables are constructed as shown in Figure 1. The ribbons in RCT cables feature 12 or 24 fibers per ribbon. Cables with 288 or more fibers are typically built with ribbons featuring 24 fibers per ribbon. Each cable consists of a single central tube that encloses the ribbons.

Breakout kits for RCT cables contain a single breakout base attached to the central tube. Protective tubing is attached to the breakout base in 5-meter lengths (see Figure 2). Smaller protective tubing can accommodate up to six ribbons featuring 12 fibers per ribbon. Larger tubing is used for ribbons with 24 fibers per ribbon.

For mass fusion ribbon splicing, CommScope recommends splicing 72 fibers per tray. For ribbon featuring 12 fibers per ribbon, six ribbons would be spliced in each tray. For ribbon featuring 24 fibers per ribbon, three ribbons would be spliced in each tray.

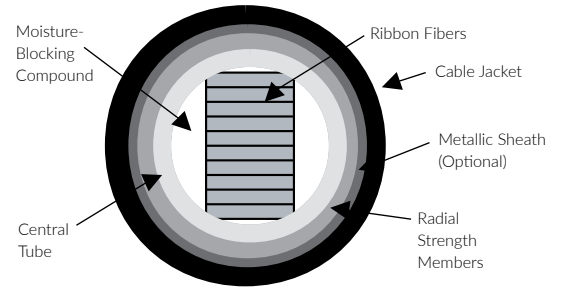

Figure 1
Ribbon central tube (RCT) OSP cable construction

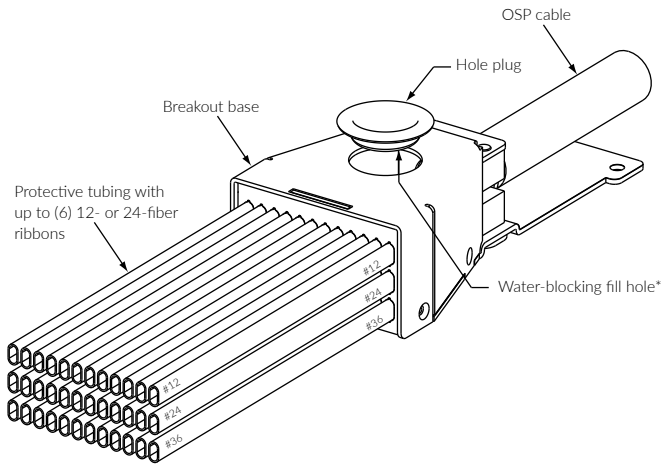

Figure 2
Breakout kit for RCT cable

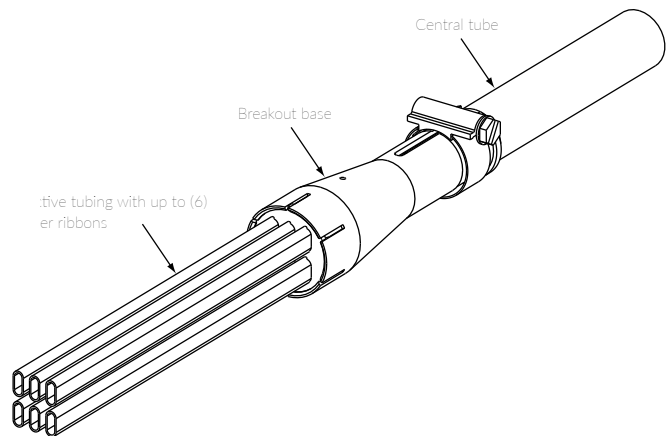

Figure 3
Breakout kit for RCT cable

RCT breakout kit typical configurations

432- and 864-fiber ribbon in central tube (RCT) OSP cables featuring 24 fibers per ribbon are common. The table below shows the number of protective tubes per breakout base required for 432- and 864-fiber cables based on the number of fibers per tray. This kit is used to protect fiber ribbons between the cable clamp and splice tray.

Number of fibers per Tray	Number of ribbons per protective tube	432-fiber central tube OSP cable, 24-fiber ribbon	864-fiber central tube OSP cable, 24-fiber ribbon
24	1	18	36
48	2	9	18
72	3	6	12

Breakout kits with 36 protective tubes use a large breakout base, kits with 9–18 protective tubes use a medium breakout base and kits with 6 protective tubes use a small breakout base.

Ordering information

BLK - RCT - 0

Ribbon type

A	< / = 12-fiber
B	24-fiber

Number of protective tubes per breakout base¹

01	Refer to figure 3 (Pg 27) for kit style
02	
03	
04	
05	
06	
09	Refer to figure 3 (Pg 27) for kit style
12	
16	
18	
24	
36	

General tube outside diameter

	General tube outside diameter	Fiber count	Number of fibers per ribbon
B	5 mm – 8 mm (0.2" – 0.33")	12-96	12
C	8 mm – 11 mm (0.33" – 0.43")	108-216	12
D	11 mm – 15 mm (0.43" – 0.6")	240-432	24
E	15 mm – 20 mm (0.6" – 0.8")	576, 720, 864	24, 36

¹ 1-6 ribbons may be placed in each protective tube with either 12 or 24 fibers per ribbon. Protective tubing length = 5 meters

¹ Divide the number of fibers per central tube (typically between 144 and 864) by the number of fibers (12, 24, 36, 48, 72) to be spliced in each splice tray.

Example: If the central tube has 864 fibers with 36 fibers per splice tray, then the breakout base would require 24 protective tubes.

For installation instructions, refer to user manual ADCP-93-305.

Breakout kit for intrafacility (IFC) ribbon cables

CommScope's ribbon IFC cables have a central tube construction. The ribbons in IFC cables feature 12 fibers per ribbon. A central tube encloses the ribbons and features fiber counts ranging from 24 fibers to 216 fibers. Central tubes with 72, 96, 144 and 216 fibers are most common.

Breakout kits for these cables can be configured from the information listed on page 31. The breakout kits for IFC cables contain a single breakout base attached to the central tube. Protective tubing is attached to the breakout base in 5-meter lengths and can accommodate up to six ribbons featuring 12 fibers per ribbon.

For mass fusion ribbon splicing, CommScope recommends splicing 72 fibers per tray. For ribbon featuring 12 fibers per ribbon, six ribbons would be spliced in each tray. For ribbon featuring 24 fibers per ribbon, three ribbons would be spliced in each tray.

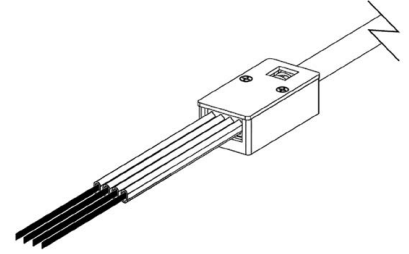

Breakout kit for IFC ribbon cables

Ordering information

IFC cable fiber count	Number of fibers per tray	Part number
72	36	BLK-RIFC-A02B0
72	72	BLK-RIFC-A01B0
96	48	BLK-RIFC-A02B0
144	36	BLK-RIFC-A04C0
144	72	BLK-RIFC-A02C0
216	36	BLK-RIFC-A06C0
216	72	BLK-RIFC-A03C0
432	72	BLK-RIFC-A06E0

IFC breakout kit typical configurations

When splicing IFC ribbon cables, CommScope recommends 72 fibers per tray.

Ordering information



Number of protective tubes per breakout base ^{1,2}

01	One
02	Two
03	Three
04	Four

General tube outside diameter

B	5 mm – 8 mm (0.2" – 0.33")
C	8 mm – 11 mm (0.33" – 0.43")
D	11 mm – 15 mm (0.43" – 0.6")
E	15 mm – 20 mm (0.6" – 0.8")

¹ 1–6 ribbons may be placed in each protective tube CommScope recommends 6 ribbon units (72 fibers) per tube. Protective tubing length = 5 meters

² The number of protective tubes per central tube is calculated as follows:
Divide the number of fibers per central tube (typically between 72 and 216) by the number of fibers (12, 24, 36, 48, 72) to be spliced in each splice tray.

Example: If the central tube has 144 fibers with 36 fibers per splice tray, then the breakout base would require four protective tubes.

For installation instructions, refer to user manual ADCP-93-305.
Please contact CommScope Technical Assistance Center.

Frame extender

The frame extender is used to extend the height of a 7-foot frame to the appropriate super structure height so that it can be secured overhead. NG4access chassis are designed to be mounted up to 7 feet. Frame extenders do not extend the chassis mounting capacity.

Ordering information

Description	Part number
Frame Extender 610 mm (24")	NG4-ACCFR1EXT-24
Frame Extender 1.37 m (54")	NG4-ACCFR1EXT-54

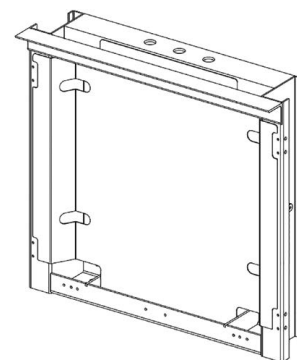

End guard

Ordering information

Description	Dimensions (HxWxD)	Part number
End guard mounts on NG4access frame	2.14 m x 64 mm x 610 mm (7' x 2.5" x 24")	NG4-ACCEGDB1

Frame installation kits

Ordering information

Description		Part number
Frame installation kits for	Computer floor	FDF-ACC146
	Overhead support	RINST-TOP7
	Concrete floor	RINST-FLR

Frame transition kits

Frame transition kits are available to cap and grow from existing legacy ODF line-ups to new NG4access line-ups. Transition kits allow for cross-connect jumpers to route between old and new frames.

Ordering information

Description	Width	Part number
NG4access to NG3 frames	0"	NG4-ACCNG3TRANS
NG4access to NGF frames	2.5"	NG4-ACCNGFTRANS
NG4access to 8" FDF frames	12"	NG4-ACC8TRANS
NG4access to 15" LGX frames	12"	NG4-TRNGEN2TWNFF15

Isolation pad

A template for frame installation providing isolation between the frame, fiber optic terminal storage bay, end guard and the floor.

Ordering information

Description		Part number
Isolation pad for	NG4access frame	NG4-ACCISOPFRM
	Fiber optic terminal jumper storage panel	NG4-ACCISOPFOTSP
	NG4access end guard	NG3-ACCISOPEGD

Replacement access tray

Ordering information

Description	Part number
Single access tray; (empty) for replacement in NG4access chassis. This kit can replace access trays on either the left or right side of the chassis.	NG4-ACCTRAYKIT1



Replacement access tray

Replacement access tray door kit

Ordering information

Description	Part number
Kit of 5 access tray doors, springs and laser eye protection label	NG4-ACCTRAYKIT5



NG4-ACCTRAYKIT5

Rear chassis door kits

Flip down door kits are available for rear chassis installation and include the mounting bracket and designation cards.

Ordering information

Description	Part number
Rear door, bracket and designation labels	NG4-ACCRDOORKIT1



Rear chassis door kit and designation cards

Designation cards

Designation cards for universal chassis.

Ordering information

Description	Part number
Kit of 24 cards; for front or rear door	NG4-ACCCARDKIT1

1.2 mm cable patch cords

CommScope's revolutionary 1.2 mm small form factor patch cords are available with LC or SC connectors and occupies half the space of traditional 1.6 mm patch cords and a third of the space of traditional 2.0 mm patch cords. In environments where space constraints and cable routing prove most challenging, the 1.2 mm patch cords offer the necessary flexibility and quality to realize significant labor and cost savings for service providers.

Features

- SC/UPC, SC/APC, LC/UPC and LC/APC connector versions
- Reduced Bend Radius fiber OFNP cable
- Compatible with industry standard fiber cable and SC and LC connectors
- Same tensile strength and crush rating as 1.6 mm, 2.0 mm or 3 mm patch cords

Recommended patch cord length (in meters)

Number of adjacent frames

	1	2	3-4	5-6	7-8	9-10	11-12	13-14
Without FOTSPs	6	7	8	9	11	13	14	15
With FOTSPs	6	7	9	11	13	15	16	18



1.2 mm SC patch cord



1.2 mm LC patch cord

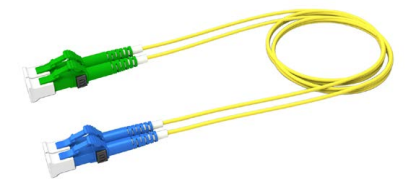

Dual LC patch cord

Ordering information

Description			Part number
Singlemode, ONFP jacket; 1.2 mm fiber jumper	SC - SC	SC/UPC - SC/UPC	FPCA-77YPxxxM
		SC/UPC - SC/APC	FPCA-7EYPxxxM
		SC/APC - SC/APC	FPCA-EEYPxxxM
	LC - LC	LC/UPC - LC/UPC	FPCA-KKYPxxxM
		LC/UPC - LC/APC	FPCA-KMYPxxxM
		LC/APC - LC/APC	FPCA-MMYPxxxM
	Hybrid SC- LC	SC/UPC - LC/UPC	FPCA-7KYPxxxM
		SC/UPC - LC/APC	FPCA-7MYPxxxM
		SC/APC - LC/UPC	FPCA-EKYPxxxM
		SC/APC - LC/APC	FPCA-EMYPxxxM

Description			Part number
Singlemode, ONFP jacket; 1.2 mm duplex fiber jumper	SC - SC	SC/UPC - SC/UPC	FPCC-77YPxxxM
		SC/UPC - SC/APC	FPCC-7EYPxxxM
		SC/APC - SC/APC	FPCC-EEYPxxxM
	LC - LC	LC/UPC - LC/UPC	FPCC-KKYPxxxM
		LC/UPC - LC/APC	FPCC-KMYPxxxM
		LC/APC - LC/APC	FPCC-MMYPxxxM
	Hybrid SC- LC	SC/UPC - LC/UPC	FPCC-7KYPxxxM
		SC/UPC - LC/APC	FPCC-7MYPxxxM
		SC/APC - LC/UPC	FPCC-EKYPxxxM
		SC/APC - LC/APC	FPCC-EMYPxxxM

** xxx = length in meters: 006 = 6 m, 007 = 7 m, 010 = 10 m, 015 = 15 m

Contact CommScope's Technical Assistance Center for availability of custom lengths.

FiberGuide FlexExit

FiberGuide raceway systems offer the greatest breadth of optical raceway products in the industry. FiberGuide systems add greater flexibility and drive down installation time to ensure a smooth deployment. It is designed to protect and route fiber optic patch cords, multi-fiber cable assemblies and intrafacility fiber cable (IFC) to and from fiber splice enclosures, fiber distribution frames and fiber optic terminal devices.

FiberGuide flex exit was designed to ensure a precise fiber drop from the raceway system into CommScope's NG4access optical distribution frame (ODF) or other high-density frame solutions. It easily installs on the sidewall of the existing raceway system, and promotes 4, 6 or 12 inch fiber drops. The FiberGuide flex exit easily adjusts vertically, side-to-side and forward for precise alignment with the ODF equipment.

Benefits

- Accommodates large fiber drops into high-density optical distributions frames
- Eliminates the need for custom engineering of raceway
- Accommodates large 12" and 24" raceway systems
- Increases flexibility of existing 12 or 24" raceway systems
- Provides optimal bend radius protection
- Durability built to provide long-lasting protection for your network

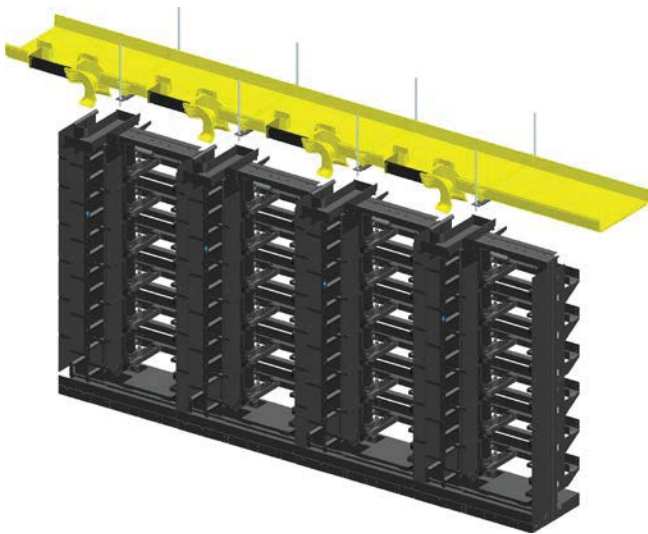

Rear fiber entry for cross-connect applications

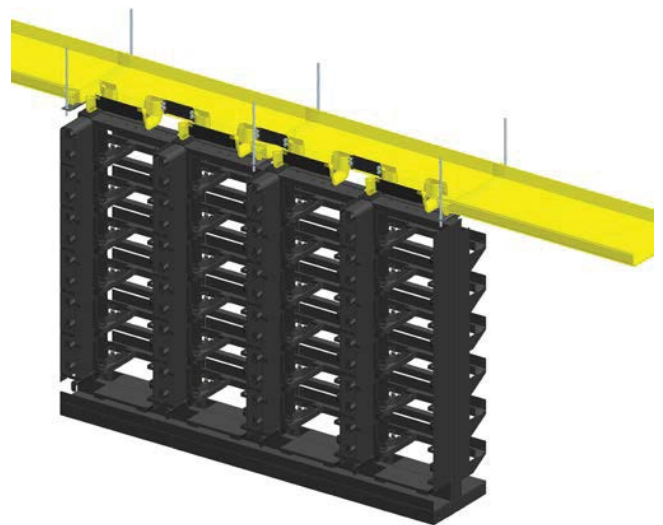

Dual front fiber entry for interconnect applications



Flex exit kit

Includes molded flex exit, sliding expansion plate and misc. support and configuration hardware. Trumpet flare or 90° down elbows must be purchased separately (see below).



Cut-in jig

The cut-in jig provides a protective guide to remove FiberGuide side wall to install the flex exit. The cut-in jig also provides a protection guide for preparing the FiberGuide raceway for cut-in depths applications.

Description	Catalog number*	
Flex exit kit	FGS-FLEXEXIT-F/H	
Cut-in Jig	FGS-FLEXJIG-F/H	
Trumpet flares (Any size trumpet flares can be attached to either exit side or both sides of the flex exit and does not require a snap fit junction kit.)		
4" trumpet flare (no junction required)	FGS-MTRM-A	
6" trumpet flare (no junction required)	FGS-MTRM-B	
12" trumpet flare (no junction required)	FGS-MTRM-H	
90° down elbows and snap fit junctions* (Any size 90° down elbow can be attached to either exit side or both sides of the flex exit and requires a snap fit junction kit to secure to the flex exit.)		
	90° down elbow	Snap fit junction
4" 90° down elbow and junction	FGS-MD9E-A	FGS-MTRM-A
6" 90° down elbow and junction	FGS-MD9E-B	FGS-MTRM-B
12" 90° down elbow and junction	FGS-MD9E-H	FGS-MTRM-H

CommScope pushes the boundaries of communications technology with game-changing ideas and ground-breaking discoveries that spark profound human achievement.

We collaborate with our customers and partners to design, create and build the world's most advanced networks. It is our passion and commitment to identify the next opportunity and realize a better tomorrow. Discover more at commscope.com

COMMSCOPE®

commscope.com

Visit our website or contact your local CommScope representative for more information.

© 2023 CommScope, Inc. All rights reserved. CommScope and the CommScope logo are registered trademarks of CommScope and/or its affiliates in the U.S. and other countries. For additional trademark information see <https://www.commscope.com/trademarks>. All product names, trademarks and registered trademarks are property of their respective owners.

BR-3141209-EN (05/23)