

VHLPX4-23-3WH/C

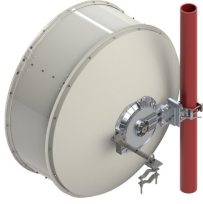

1.2 m | 4 ft ValuLine® High Performance Low Profile Antenna, dual-polarized, 21.200–23.600 GHz, UBR220, white antenna, flexible woven polymer gray radome without flash, standard pack—one-piece reflector

Product Classification

Product Type	Microwave antenna
Product Brand	ValuLine®

General Specifications

Antenna Type	VHLPX - ValuLine® High Performance Low Profile Antenna, dual-polarized
Polarization	Dual
Antenna Input	UBR220
Antenna Color	White
Reflector Construction	One-piece reflector
Radome Color	Gray
Radome Material	Flexible woven polymer
Flash Included	No
Side Struts, Included	1 inboard
Side Struts, Optional	1 inboard

Dimensions

Diameter, nominal	1.2 m 4 ft
--------------------------	--------------

Electrical Specifications

Operating Frequency Band	21.200 – 23.600 GHz
Gain, Low Band	45.7 dBi
Gain, Mid Band	46.1 dBi
Gain, Top Band	46.4 dBi
Boresite Cross Polarization Discrimination (XPD)	30 dB
Front-to-Back Ratio	74 dB
Beamwidth, Horizontal	0.8 °

VHLPX4-23-3WH/C

Beamwidth, Vertical	0.8 °
Return Loss	17.7 dB
VSWR	1.3
Radiation Pattern Envelope Reference (RPE)	7068C
Electrical Compliance	Brazil Anatel Class 2 Canada SRSP 321.8 Part A ETSI 302 217 Class 3 US FCC Part 101A

Mechanical Specifications

Compatible Mounting Pipe Diameter	115 mm 4.5 in
Fine Azimuth Adjustment Range	±15°
Fine Elevation Adjustment Range	±15°
Wind Speed, operational	200 km/h 124.274 mph
Wind Speed, survival	250 km/h 155.343 mph

VHLPX4-23-3WH/C

Antenna Dimensions and Mounting Information

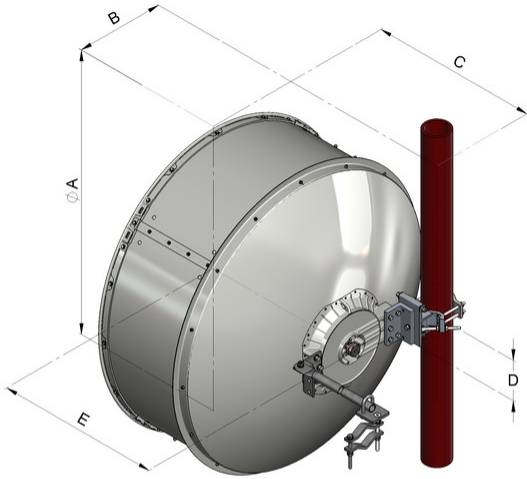

Dimensions in inches (mm)					
Antenna size, ft (m)	A	B	C	D	E
4 (1.2)	50.8 (1291)	16 (407)	30.2 (767)	7.2 (183)	29.5 (748)

Wind Forces at Wind Velocity Survival Rating

Axial Force (FA)	5326 N 1,197.333 lbf
Side Force (FS)	2638 N 593.046 lbf
Twisting Moment (MT)	2162 N-m 19,135.312 in lb
Force on Inboard Strut Side	2862 N 643.403 lbf
Zcg without Ice	43 mm 1.693 in
Zcg with 1/2 in (12 mm) Radial Ice	284 mm 11.181 in
Weight with 1/2 in (12 mm) Radial Ice	74 kg 163.142 lb

VHLPX4-23-3WH/C

Wind Forces at Wind Velocity Survival Rating Image



Packaging and Weights

Height, packed	1520 mm 59.843 in
Width, packed	380 mm 14.961 in
Length, packed	1360 mm 53.543 in
Packaging Type	Standard pack
Volume	0.8 m ³ 28.252 ft ³
Weight, gross	59 kg 130.073 lb
Weight, net	32 kg 70.548 lb

Regulatory Compliance/Certifications

VHLPX4-23-3WH/C

Agency	Classification
CHINA-ROHS	Above maximum concentration value
ISO 9001:2015	Designed, manufactured and/or distributed under this quality management system
ROHS	Compliant/Exempted
UK-ROHS	Compliant/Exempted



* Footnotes

Operating Frequency Band	Bands correspond with CCIR recommendations or common allocations used throughout the world. Other ranges can be accommodated on special order.
Gain, Mid Band	For a given frequency band, gain is primarily a function of antenna size. The gain of Andrew antennas is determined by either gain by comparison or by computer integration of the measured antenna patterns.
Boresite Cross Polarization Discrimination (XPD)	The difference between the peak of the co-polarized main beam and the maximum cross-polarized signal over an angle twice the 3 dB beamwidth of the co-polarized main beam.
Front-to-Back Ratio	Denotes highest radiation relative to the main beam, at $180^\circ \pm 40^\circ$, across the band. Production antennas do not exceed rated values by more than 2 dB unless stated otherwise.
Return Loss	The figure that indicates the proportion of radio waves incident upon the antenna that are rejected as a ratio of those that are accepted.
VSWR	Maximum; is the guaranteed Peak Voltage-Standing-Wave-Ratio within the operating band.
Radiation Pattern Envelope Reference (RPE)	Radiation patterns define an antenna's ability to discriminate against unwanted signals. Under still dry conditions, production antennas will not have any peak exceeding the current RPE by more than 3dB, maintaining an angular accuracy of $\pm 1^\circ$ throughout
Wind Speed, operational	For VHLP(X), SHP(X), HX and USX antennas, the wind speed where the maximum antenna deflection is 0.3 x the 3 dB beam width of the antenna. For other antennas, it is defined as a deflection is equal to or less than 0.1 degrees.
Wind Speed, survival	The maximum wind speed the antenna, including mounts and radomes, where applicable, will withstand without permanent deformation. Realignment may be required. This wind speed is applicable to antenna with the specified amount of radial ice.
Axial Force (FA)	Maximum forces exerted on a supporting structure as a result of wind from the most critical direction for this parameter. The individual

VHLPX4-23-3WH/C

maximums specified may not occur simultaneously. All forces are referenced to the mounting pipe.

Side Force (FS)

Maximum side force exerted on the mounting pipe as a result of wind from the most critical direction for this parameter. The individual maximums specified may not occur simultaneously. All forces are referenced to the mounting pipe.

Twisting Moment (MT)

Maximum forces exerted on a supporting structure as a result of wind from the most critical direction for this parameter. The individual maximums specified may not occur simultaneously. All forces are referenced to the mounting pipe.

Packaging Type

Andrew standard packing is suitable for export. Antennas are shipped as standard in totally recyclable cardboard or wire-bound crates (dependent on product). For your convenience, Andrew offers heavy duty export packing options.