

1.0 General Product Information

Important: Read and follow all safety precautions and warnings documented in the appropriate closure installation instructions.

The FOSC D closure ribbon splice tray is designed for use in CommScope® FOSC 200 D, 400 D, FOSC 450 D, FOSC 600 C, and FOSC 600 D splice closures and related products.

The trays are typically equipped with 4 splice modules attached to a stack module to accommodate 288 mass fusion fibers (12 fiber ribbon x 24 splices). To accommodate ribbon slack storage, D Ribbon Trays are twice the height of the standard CommScope FOSC closure trays, thereby occupying two standard tray positions in a closure.

2.0 Kit Contents

The kit contents may vary depending on version purchased. Each FOSC D closure ribbon splice tray kit consists of:

- Splice tray with cover
- Four SM-6 six-position splice modules and module holder
- Spiral tubing
- Ribbon holders
- Loose buffer tube wrap
- Tie wraps

3.0 Tray Ordering Information

3.1 Description Key

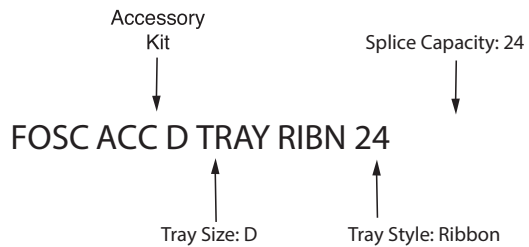

3.2 Tray Kit Information

Tray Kit	Quantity of Modules in Tray Kit	Type of Splice Module Included in Tray Kit	Splice Types Accommodated	Max. Qty. of Splices Accommodated per Tray
D Ribbon Tray Type				
FOSC-ACC-D-TRAY-RIBN-24	4	SM-6 Splice Modules	Mass Fusion	24
D Standard Type				
FOSC-ACC-D-TRAY-36	6	SM-6 Splice Modules	Single Fusion Single Mechanical Mass Fusion	36 36 36 ¹
FOSC-ACC-D-TRAY-48	6	SM-8 Splice Modules	Single Fusion Single Mechanical	48 24
FOSC-ACC-D-TRAY-72	6	SM-12 Splice Modules	Single Fusion or NT-QPAK	72 ²
FOSC-ACC-D-TRAY-96-S45	6	K12/45 (FIST) Splice Modules	Single Fusion (45mm)	96 ³
FOSC-ACC-D-TRAY-96-S60	6	K12/60 (FIST) Splice Modules	Single Fusion (60mm)	96 ⁴

- 1 May vary based on slack capacity required. Requires storing slack in slack basket or sock.
- 2 Use of CommScope SMOUV splice sleeves is highly recommended in these applications.
- 3 Comes equipped with 45mm long CommScope SMOUV splice sleeves required in these applications.
- 4 Comes equipped with 60mm long CommScope SMOUV splice sleeves required in these applications.

4.0 Installation of Tray

1. As the ribbon tray is double-height, the first available slot in the tray support bracket must be skipped (arrow, Figure 1). Holding the tray in a vertical position, insert the tray hinge pin into the second available slot with a rocking motion. (Figure 1)
2. Push the red tray support latch to the up position to lower the splice tray.

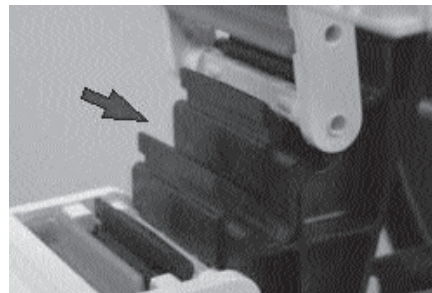

Figure 1

5.0 Preparation and Routing of Ribbons

1. Prepare main cable, strength member(s) and ribbon bundles following the procedures in the appropriate closure installation instructions for your application.
2. Install spiral tubing on ribbon bundles:
For FOSC 200, 400 or 450 closures, the spiral tubing can be secured onto the end of the central core or loose buffer tube and then routed directly to the ribbon tray.
For the FOSC 600 closure, store a single loop of the spiral-wrapped ribbon bundle in the slack tray and route up to the ribbon splice tray.
3. Install ribbon holders:
For 24-fiber ribbons, lay the ribbon bundle in the ribbon holder as shown in Figure 2A.
For 12-fiber ribbons, fold the appropriate number of spacers as shown in Figure 2C. Use the chart at right to determine number of spacers to fold down:
For 6 or less fibers, use 3 spacers.
4. Stand the 12-fiber ribbons in the ribbon holder as shown in Figure 2B.
5. Once ribbons are in the ribbon holder, fold the other half over and snap closed.
6. Slide the ribbon holder into the spiral tubing.

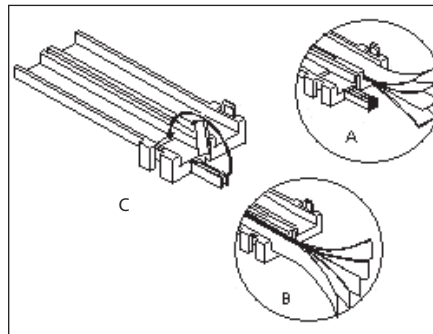

Figure 2

Ribbons	Spacers to Fold Down
24	0
12	2
6 or less	3

- Secure prepared ribbon bundles to the splice tray with tie wraps (Figure 3). Both 24- and 12-fiber ribbons should be oriented vertically when secured to the splice tray. Rotate the ribbon holder accordingly.

Note: Ribbons must measure 39" from top edge of ribbon holder for proper management and storage.

6.0 Ribbon Splicing and Management

- For best management and storage of spliced ribbons, **inner** ribbons from right side of tray should be spliced to **inner** ribbons from left side of tray, outer ribbons to outer ribbons, etc.
- Place one additional ribbon holder on each ribbon bundle to be spliced. Slide toward splicing machine. This will keep the ribbons organized in the needed order for splicing.
- Splice ribbons and store in the splice modules while out of the tray. Remove the temporary ribbon holders when all ribbons have been spliced.
- Modules should be filled in the order specified in Figure 4.
- For best results, rotate filled modules 1 and 2 one complete turn (Figure 5, see arrows) and snap into ribbon tray. This will create a twist on each ribbon and allow them to lie more neatly in the tray.
- For modules 3 and 4, store splices, insert modules into stack module, and rotate entire stack module assembly as described in step 5. Then place the stack module on top of the original splice module as shown in Figure 6.

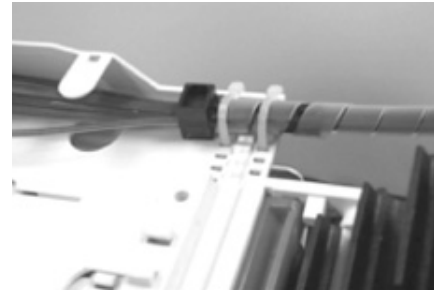

Figure 3

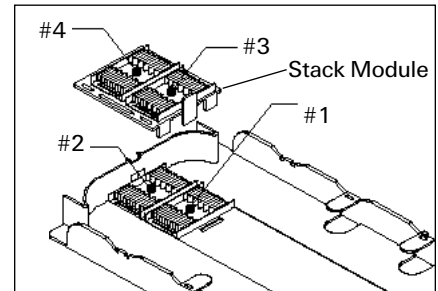

Figure 4

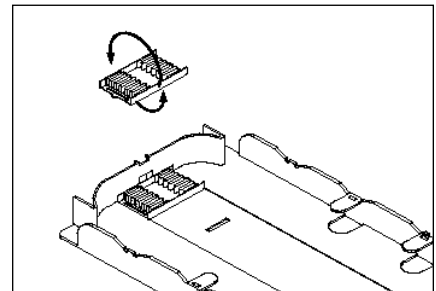

Figure 5

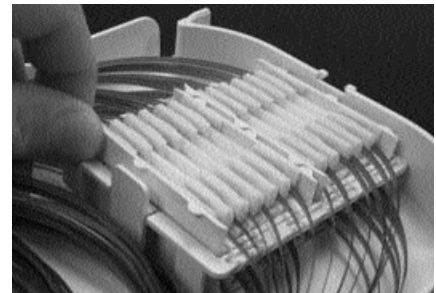

Figure 6

7.0 Additional Ordering Information

Splice modules and SMOUV splice protection sleeves are also available separately. See below for ordering information.

Splice Modules

Splice Module Kit	Quantity per package	Splice Types Accommodated	Splices per Module
FOSC-ACC-SM6-MODULES	48	Single Fusion Single Mechanical Single Mass	6
FOSC-ACC-SM8-MODULES	48	Single Fusion Single Mechanical	8
FOSC-ACC-SM12-MODULES	48	Single Fusion or NT-QPAK	12*

* Use of SMOUV splice protection sleeves is highly recommended in this application.

SMOUV Splice Protection Sleeves

SMOUV 1120 splice protector sleeves provide mechanical and environmental protection for fusion splices of single and ribbonized fiber.

The SMOUV 1120 sleeve consists of:

- clear outer heat-shrink material
- low temperature hot-melt adhesive to encapsulate the splice
- stainless steel rod for single fiber splices and a ceramic rod for ribbonized fiber splices to ensure proper alignment and rigidity.

SMOUV 1120 sleeves for single fibers are ideal for protecting single fusion splices of primary and secondary tight or semi-tight coated fibers.

SMOUV 1120 sleeves for multiple fibers are ideal for protecting mass fusion splices of ribbons with two to twelve fibers. All SMOUV 1120 sleeves are compatible with the full range of CommScope fiber management systems and organizers.

SMOUV Splice Sleeve Sizes and Specifications

Product Name	Fiber Type	Lengths (in millimeters)		
		Tubing	Adhesive	Rod
SMOUV 1120-01-US	Single	62	59	56
SMOUV 1120-02-US	Single	45	42	40
SMOUV 1120-03-US	Single	23	21	18
SMOUV 1120-R2/12-02-US	Ribbon	42	42	40

*Ceramic rod

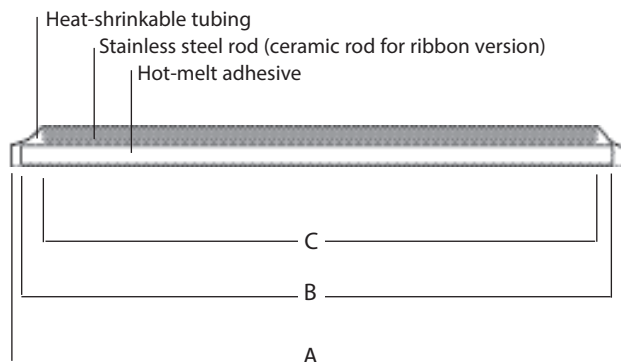

Technical Assistance Center (TAC)

Tel.: 800.830.5056
 Email: TAC.Americas@commscope.com
 www.commscope.com

FOSC 200, FOSC 400, FOSC 450, FOSC 600, SMOUV, CommScope, and the CommScope logo are trademarks.

The information given herein, including drawings, illustrations and schematics which are intended for illustration purposes only, is believed to be reliable. However, CommScope makes no warranties as to its accuracy or completeness and disclaims any liability in connection with its use. CommScope's obligations shall only be as set forth in CommScope's Standard Terms and Conditions of Sale for this product and in no case will CommScope be liable for any incidental, indirect or consequential damages arising out of the sale, resale, use or misuse of the product. Users of CommScope products should make their own evaluation to determine the suitability of each such product for the specific application.