

Installation Instructions

Connector Attachment

For Braided Cable CNT-400/CNT-400-FLEX & C2FP
 7-16 Din Male, Right Angle,
 Solder Pin, Crimp-type Body: 400PDR-CR

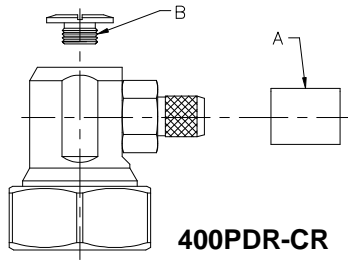

400PDR-CR

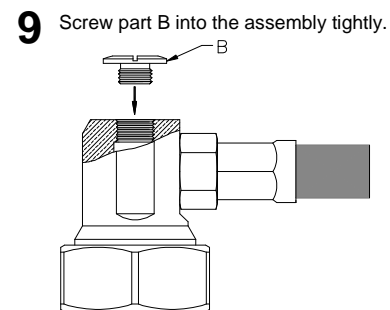
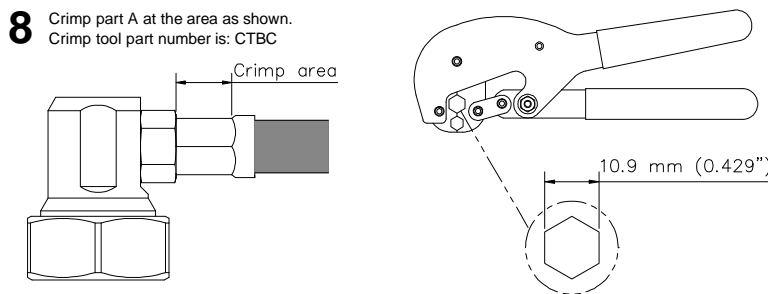
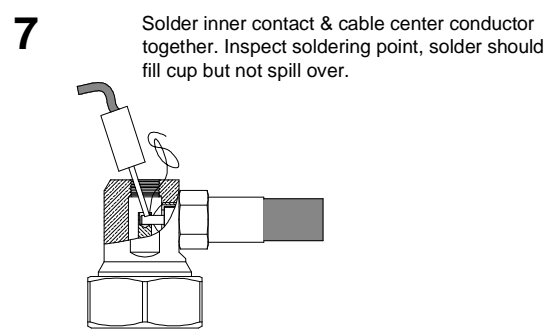
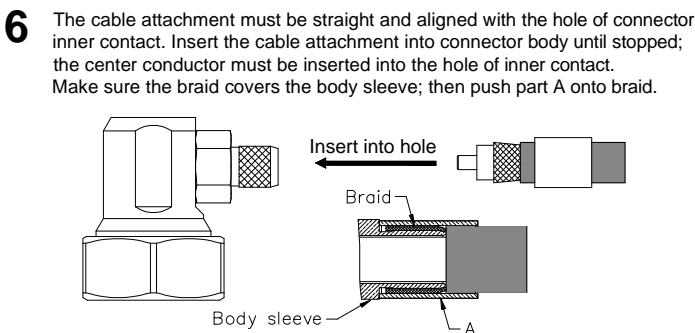
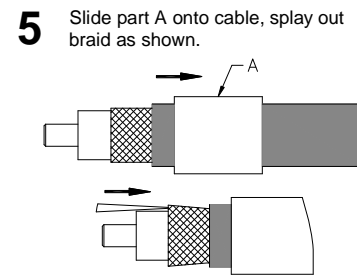
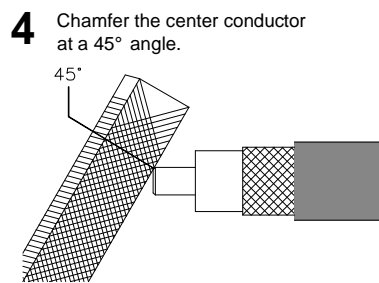
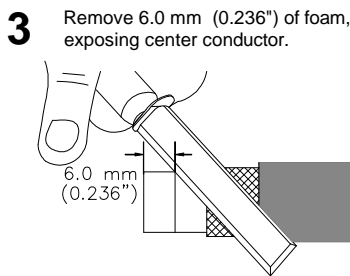
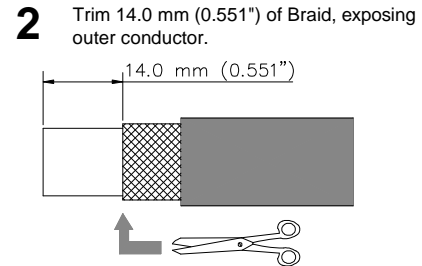
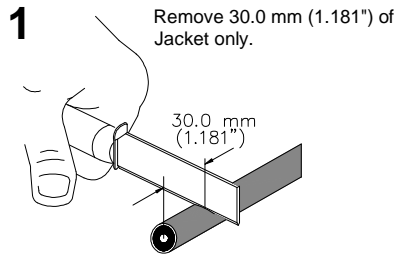

	表一 有毒有害物质或元素名称及含量标识格式					
	有毒有害物质或元素					
部件名称 (Part Name)	铅 (Pb)	汞 (Hg)	镉 (Cd)	六价铬 (Cr6+)	多溴联苯 (PBB)	多溴二苯醚 (PBDE)
连接器 (Connector)	X	O	O	O	O	O

O: 表示有毒有害物质在该部件所有的均质材料中的含量均在SJ/T 11363-2006规定的限量要求以下。
 X: 表示该有毒有害物质至少在该部件的某一均质材料中的含量超出SJ/T 11363-2006规定的限量要求。



Installation Training Available at Andrew Institute

Notice: Andrew disclaims any liability or responsibility for the results of improper or unsafe installation, inspection, maintenance, or removal practices

Andrew Wireless Solutions
 3 Westbrook Corporate Center, Suite 900, Westchester, Illinois U.S.A. 60154
 +1 (708) 349-3300 Fax (U.S.A.): 1-800-349-5444
 www.andrew.com
 Copyright © 2011 by Commscope Corporation

Customer Service, 24 hours
 U.S.A., Canada, Mexico: 1-800-255-1479
 U.K.: 0800 250055
 Other Europe: +44 592 782 612