

MFPS Fiber Optic panel, 1RU, 48 fibers/RU, pre-cabled I/O LSZH, 30m, front patch cords orientation to the left, 48 LC/UPC, grade C

- Supplied with connectorized cables from 48F up to 96F, and a stub on the far end (10, 20 or 30m)
- Suitable for cabinets and POP locations
- Supports patch cord diameters of 1.2 to 2.4mm (XD-series require the usage of 1.2mm patch cords)

Product Classification

Regional Availability	EMEA
Portfolio	CommScope®
Product Type	Fiber patch panel, with indoor/outdoor cable
Product Series	MFPS

General Specifications

Functionality	Patching
Cable Exit Location	Side
Cable Stub Type	Indoor/outdoor, stranded
Color	Gray
Door Type, front	Compression latch Hinged
Growth Configuration	Fully loaded
Interface, front	LC/UPC
Interface, rear	Stub tail
Patch Cord Entry Location	Front, left side
Patch Cord Routing	Left sided
Rack Type	EIA 19 in ETSI 600 mm
Rack Units	1
Shelf Movement	Hinged
Total Ports, quantity	48
Transmission Standards	ETSI EN 300 019-1-3 IEC 61300-3-34

Dimensions

Height	44.45 mm 1.75 in
---------------	--------------------

760241877 | MFPS-KHD-P-CRL1-048-30-OF

Width	482.6 mm 19 in
Depth	279.91 mm 11.02 in
Cable Length	30 m 98.425 ft

Port Configuration

MFPS Capacities		48		72	96
Connector Type		SC	LC	LC	LC Adapter Pack
19 inch	1HU	48	48	72	96
	2HU	96	96		
	2.8 HU				

Ordering Tree

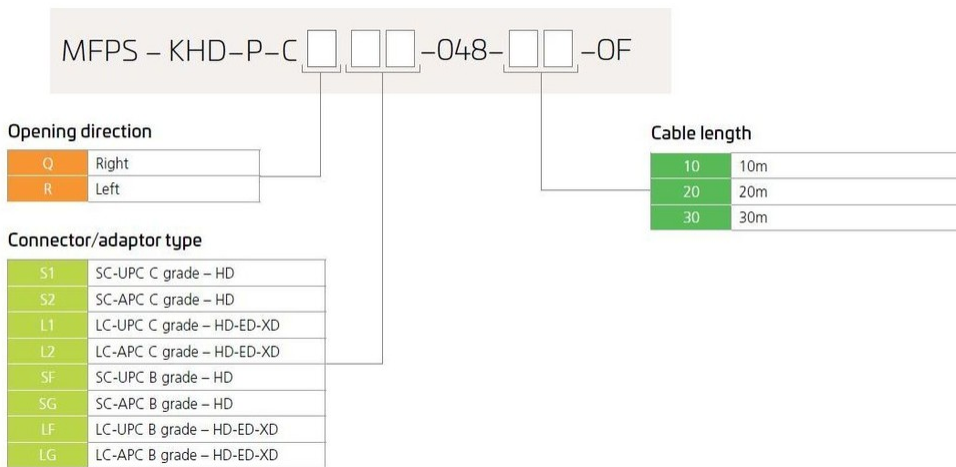

Material Specifications

Finish	Powder coated
Material Type	Ethylene-propylene (EP) Polyethylene terephthalate (PET)

Optical Specifications

Fiber Mode	Singlemode
Fiber Type	G.657.A1
Performance Grade	Standard C grade

Environmental Specifications

Operating Temperature	-40 °C to +70 °C (-40 °F to +158 °F)
Storage Temperature	-20 °C to +85 °C (-4 °F to +176 °F)
EN50575 CPR Cable EuroClass Fire Performance	Dca
Flammability Rating	UL 94 V-0

Packaging and Weights

Included	Mounting hardware One cable termination kit
Packaging quantity	1

Regulatory Compliance/Certifications

Agency	Classification
CHINA-ROHS	Above maximum concentration value
ISO 9001:2015	Designed, manufactured and/or distributed under this quality management system
REACH-SVHC	Compliant as per SVHC revision on www.commscope.com/ProductCompliance
ROHS	Compliant/Exempted
UK-ROHS	Compliant/Exempted



* Footnotes

Performance Grade	Guarantee to meet IEC 61755-1 Random Mating requirement
--------------------------	---