

PFC-304L16



Powered Fiber Cable, OM3, 4 Fibers, Indoor/Outdoor, 16AWG Conductor, meter, feet

- Easy peel, stranded conductors for maximum cable flexibility and rapid access
- Polarization indentation along one side of the cable for polarity identification
- No special tools or mounting hardware required - usage of a standard "FTTH" pressure clamp for aerial installation
- Easy split of cable into three separate sections for separate routing in closures, as needed for installation
- Riser/LSZH jacket for indoor/outdoor applications

Product Classification

Regional Availability

Asia | Australia/New Zealand | EMEA | Latin America | North America

Product Type

Hybrid cable, fiber and power

Ordering Note

Minimum order quantity is 500 meter

General Specifications

Cable Type

Stranded indoor/outdoor

Fiber Short Description

PFC-L16

Jacket Color

Black

Total Fiber Count

4

Dimensions

Height Over Jacket

4.318 mm | 0.17 in

Width Over Jacket

11.43 mm | 0.45 in

Conductor Gauge

16 AWG

Outline Drawing

PFC-304L16

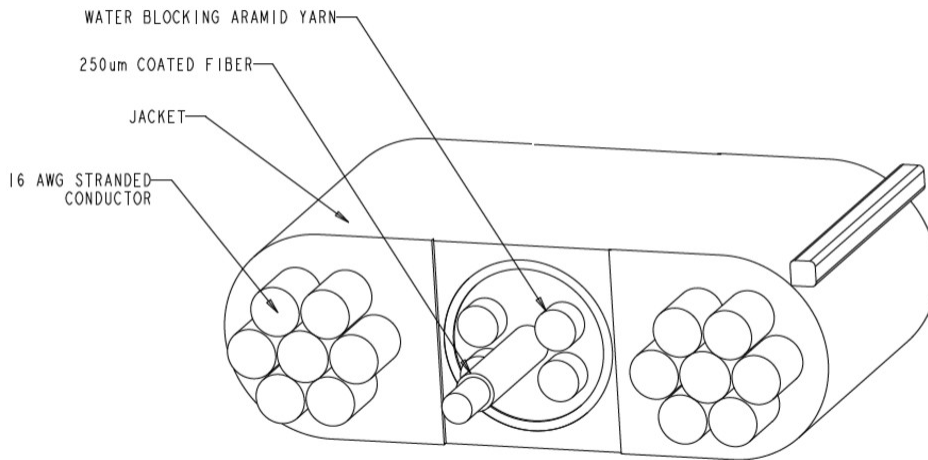

Mechanical Specifications

Minimum Bend Radius, loaded	88.9 mm 3.5 in
Minimum Bend Radius, unloaded	45.72 mm 1.8 in
Tensile Load, long term, maximum	133.447 N 30 lbf
Tensile Load, short term, maximum	440.374 N 99 lbf
Vertical Rise, maximum	122.011 m 400.3 ft

Optical Specifications

Fiber Type	OM3, bend insensitive
-------------------	-----------------------

Environmental Specifications

Installation temperature	-10 °C to +60 °C (+14 °F to +140 °F)
Operating Temperature	-40 °C to +70 °C (-40 °F to +158 °F)
Storage Temperature	-40 °C to +70 °C (-40 °F to +158 °F)
Cable Qualification Standards	Telcordia GR-20-CORE Issue 4
EN50575 CPR Cable EuroClass Fire Performance	Dca
EN50575 CPR Cable EuroClass Smoke Rating	s1a
EN50575 CPR Cable EuroClass Droplets Rating	d1
EN50575 CPR Cable EuroClass Acidity Rating	a1
Environmental Space	Low Smoke Zero Halogen (LSZH) Riser

PFC-304L16

Flame Test Method

IEC 60332-1-2 | IEC 60754-2 | IEC 61034-2 | NFPA 130 | UL 1666 | UL 444

Jacket UV Resistance

UV stabilized

Packaging and Weights

Cable weight

69.944 kg/km | 47 lb/kft

Regulatory Compliance/Certifications

Agency**Classification**

CENELEC

EN 50575 compliant, Declaration of Performance (DoP) available



Included Products

CS-5E-PFC – 50µm OM3 Bend-Insensitive Multimode Fiber

CS-5E-PFC

50µm OM3 Bend-Insensitive Multimode Fiber

Product Classification

Portfolio	CommScope®
Product Type	Optical fiber

General Specifications

Cladding Diameter	125 µm
Cladding Diameter Tolerance	±0.8 µm
Cladding Non-Circularity, maximum	0.7 %
Coating Diameter (Colored)	242 µm
Coating Diameter Tolerance (Colored)	±7 µm
Coating/Cladding Concentricity Error, maximum	10 µm
Core Diameter	50 µm
Core Diameter Tolerance	±2.5 µm
Core/Clad Offset, maximum	1 µm
Proof Test	689.476 N/mm ² 100000 psi

Mechanical Specifications

Macrobending, 15 mm Ø mandrel, 2 turns	0.20 dB @ 850 nm 0.50 dB @ 1,300 nm
Macrobending, 30 mm Ø mandrel, 2 turns	0.10 dB @ 850 nm 0.30 dB @ 1,300 nm
Coating Strip Force, maximum	8.9 N 2.001 lbf
Coating Strip Force, minimum	1.3 N 0.292 lbf
Dynamic Fatigue Parameter, minimum	25

Optical Specifications

Numerical Aperture	0.2
Numerical Aperture Tolerance	±0.015
Point Defects, maximum	0.2 dB
Zero Dispersion Slope, maximum	0.105 ps/[km-nm-nm]
Zero Dispersion Wavelength, maximum	1340 nm
Zero Dispersion Wavelength, minimum	1295 nm

CS-5E-PFC

Optical Specifications, Wavelength Specific

Attenuation, maximum	1.20 dB/km @ 1,300 nm 3.00 dB/km @ 850 nm
Backscatter Coefficient	-68.0 dB @ 850 nm -75.7 dB @ 1,300 nm
Bandwidth, Laser, minimum	2,000 MHz-km @ 850 nm 500 MHz-km @ 1,300 nm
Bandwidth, OFL, minimum	1,500 MHz-km @ 850 nm 500 MHz-km @ 1,300 nm
Differential Mode Delay Note	Superior to TIA-492AAAC and IEC 60793-2-10 at 850 nm
Index of Refraction	1.477 @ 1,300 nm 1.482 @ 850 nm
Standards Compliance	TIA-492AAAC (OM3)

Environmental Specifications

Heat Aging, maximum	0.10 dB/km @ 85 °C
Temperature Dependence, maximum	0.1 dB/km
Temperature Humidity Cycling, maximum	0.1 dB/km
Water Immersion, maximum	0.10 dB/km @ 23 °C

Regulatory Compliance/Certifications

Agency	Classification
ISO 9001:2015	Designed, manufactured and/or distributed under this quality management system



* Footnotes

Temperature Dependence, maximum	Temperature dependence is conducted at -60 °C to +85 °C (-76 °F to +185 °F)
Temperature Humidity Cycling, maximum	Temperature humidity cycling is conducted at -10 °C to +85 °C (+14 °F to +185 °F) up to 95% relative humidity