

## CHD-ES 1U Front Trough

### General

The CHD-ES 1U Front Trough provides better jumper management for 1U Panel on the rack.

Ordering information is listed below:

Material ID	Description	Remark
760248339	CHD-ES-TROUGH-1U	CHD-ES 1U Front Trough



The CHD-ES 1U Trough works with panels listed below:

Material ID	Description	Remark
760248335	CHD-ES-1U	CHD-ES Empty Panel, Fixed, supports 12 pcs CHD-ES plates
760241517	AGL-1U-FX	AGL Empty Panel, Flat, Fixed, supports 4 pcs G2 Modules
760241518	AGL-1U-ANG-FX	AGL Empty Panel, Angle, Fixed, supports 4 pcs G2 Modules



760248335 CHD-ES-1U



760241517 AGL-1U-FX



760241518 AGL-1U-ANG-FX

**Accessories kit for Trunk Cable Fixed:**

Material ID	Description	Remark
760249052	CHD-ES-RMB-5-3/4	CHD-ES Rack Mounted Bracket for 5 x 3/4" gland
760249053	CHD-ES-RMB-6-1/2	CHD-ES Rack Mounted Bracket for 6 x 1/2" gland



760249052 CHD-ES-RMB-5-3/4



760249053 CHD-ES-RMB-6-1/2

**Install CHD-ES 1U Trough to Equipment Rack**

- a. Unscrew the screws but do not unscrew them completely

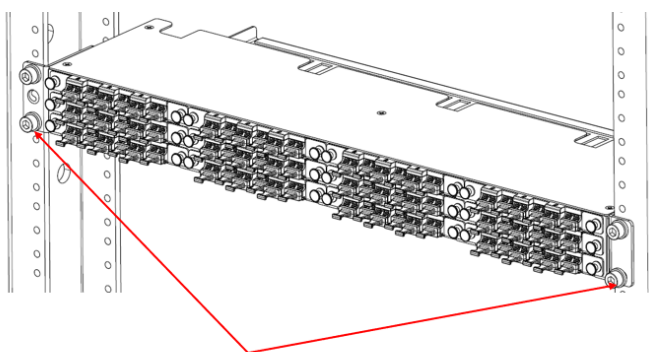

Unscrew the two screws

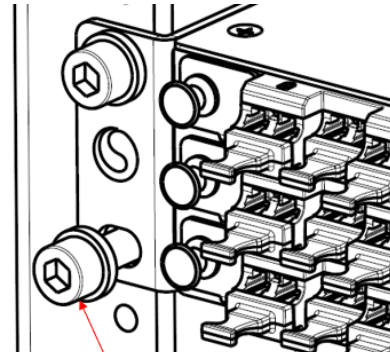

The screw is still on the rack

- b. Put the 1U trough on the rack as below shown, then tighten the two screws.

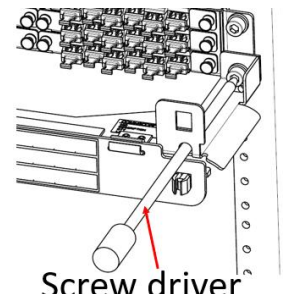
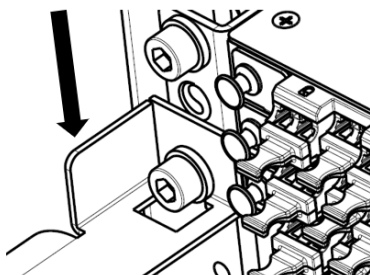
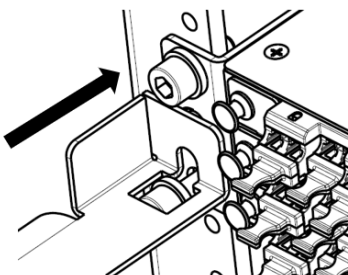

### CHD-ES-1U With Trough

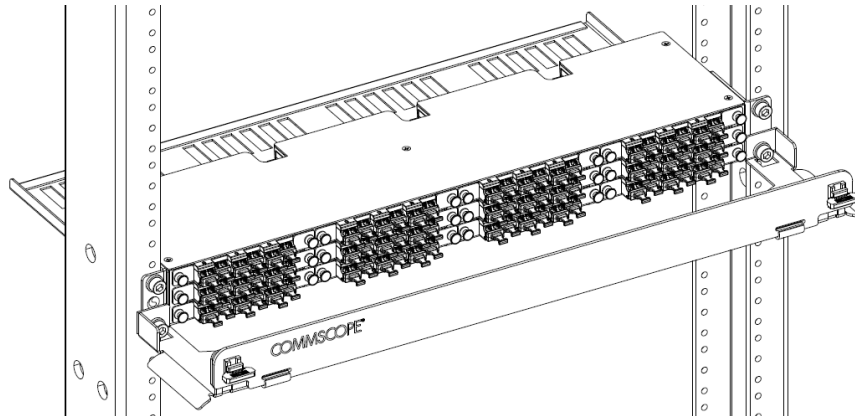

### AGL-1U-FX With Trough

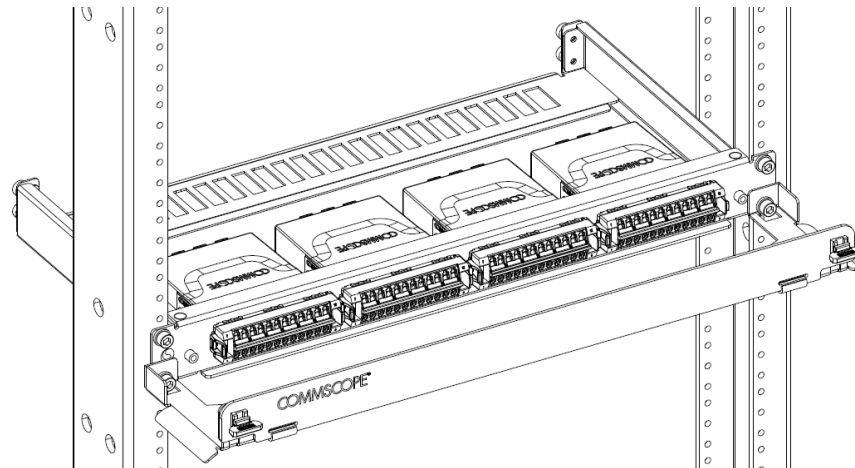

### AGL-1U-ANG-FX With Trough

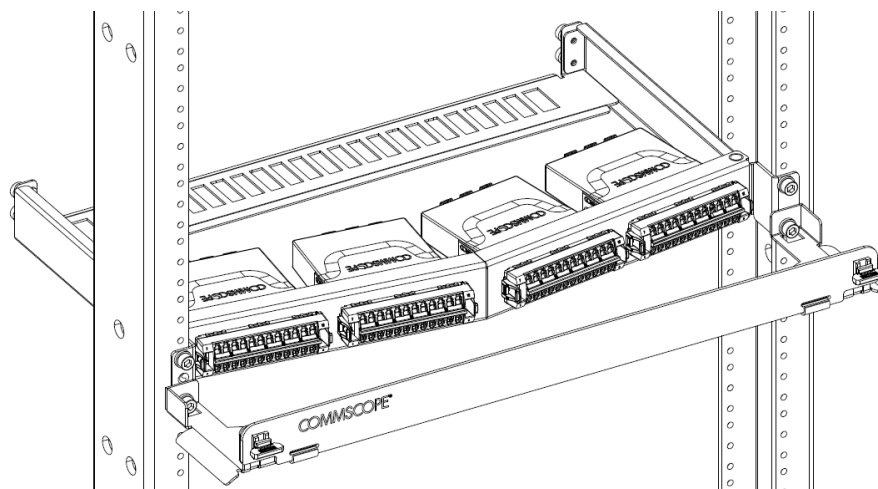

## Trunk Cable Fixed with RMB Bracket

a. CHD-ES Panel

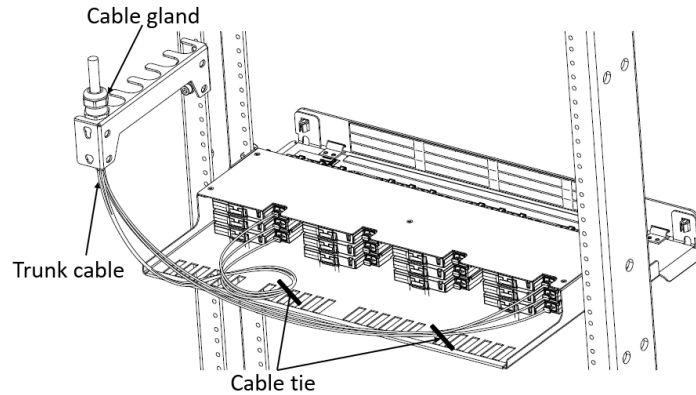

b. AGL-1U-FIX Panel

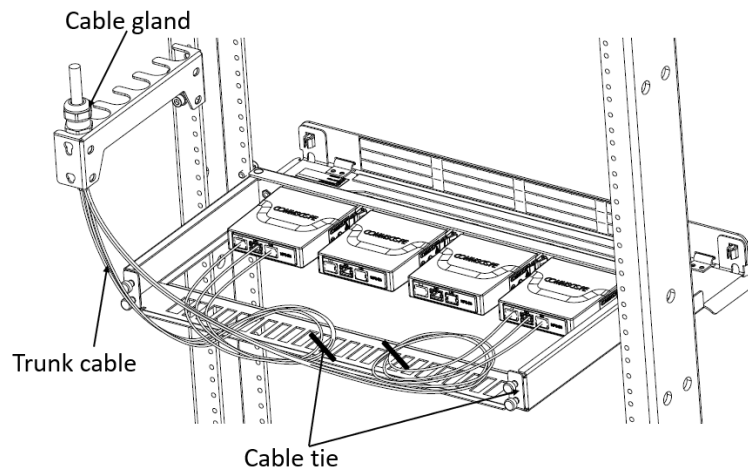

c. AGL-1U-ANG-FIX Panel

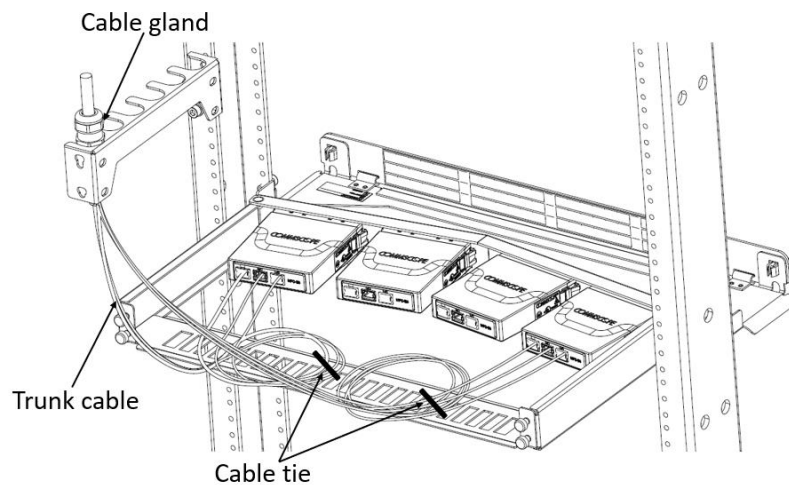

## How to Contact Us

- To find out more about **CommScope**® products, visit us on the web at <http://www.commscope.com/>
- For technical assistance, customer service, or to report any missing/damaged parts, visit us at <http://www.commscope.com/SupportCenter>