



DLX® Mini-MST, Fiber Optic Multiport Service Terminal, 4-port, round cable, 50 m

- Hardened connectors are factory-terminated and environmentally sealed for use in optical drop cable deployments
- Plug-and-play adapter ports ensure rapid cable installment in the outside plant access section of the network
- Multiport Service Terminals incorporate hardened connector technology that is designed to withstand the rugged outside plant environment

Product Classification

Product Type	Access terminal, without splitter/tap
Product Series	Mini-MST
Product Brand	DLX®
Regional Availability	EMEA

General Specifications

Distribution Type	4 ports
Port, quantity	4
Cable Type	Armored - Round - Loose Tube
Port Type	Hardened mini-size DLX
Stub Type	Stub tail
Cable, quantity	1
Enclosure Color	Gray
Package, quantity	1
Packaging Type	Box Carton
Splitter, quantity	0

Dimensions

Cable Length	50.00 m 164.04 ft
Depth	58.70 mm 2.31 in
Height	214.80 mm 8.46 in
Outer Cable Dimensions	5.0 mm (0.20 in)
Weight, without cable	0.99 kg 2.18 lb
Width	150.00 mm 5.91 in

Dimension Drawing

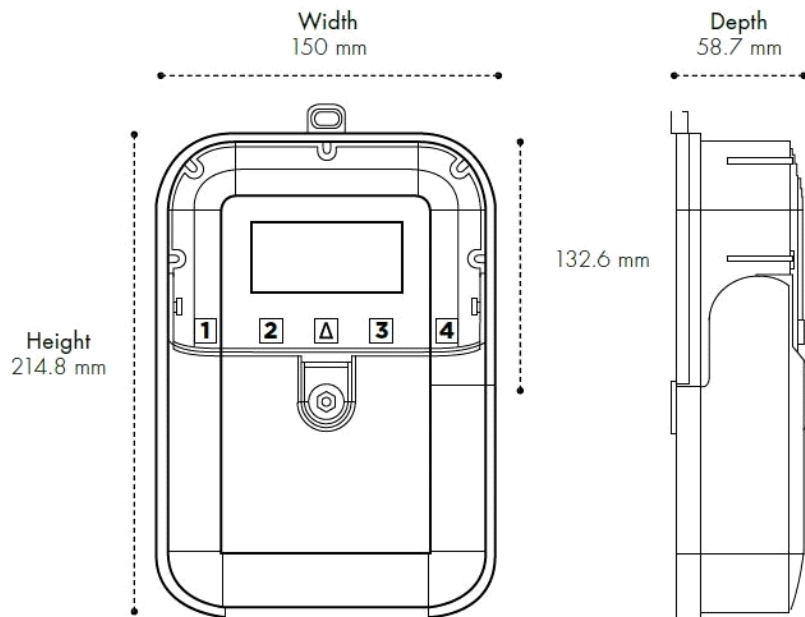

Mechanical Specifications

Enclosure Material Type	Gasketed hardened plastic
Mount Type	Handhole Wall

Optical Specifications

Fiber Type	G.657.A1
Insertion Loss, Terminal Connector, maximum	0.40 dB
Insertion Loss, Terminal Connector, typical	0.16 dB
Return Loss, Connector, minimum	65 dB
Wavelength Range	1260–1635 nm

Environmental Specifications

Environmental Space	Above ground Below ground
Operating Temperature	-40 °C to +70 °C (-40 °F to +158 °F)
Qualification Standard	IEC 60529, IP65
Relative Humidity	5%–95%, non-condensing
UV Resistance	UV stabilized

Regulatory Compliance/Certifications

Agency

RoHS 2011/65/EU
ISO 9001:2015

Classification

Compliant
Designed, manufactured and/or distributed under this quality management system

