



DLX® Mini-MST, Fiber Optic Multiport Service Terminal, 4-port, round cable, 300 m

- Hardened connectors are factory-terminated and environmentally sealed for use in optical drop cable deployments
- Plug-and-play adapter ports ensure rapid cable installment in the outside plant access section of the network
- Multiport Service Terminals incorporate hardened connector technology that is designed to withstand the rugged outside plant environment

## Product Classification

<b>Product Type</b>	Access terminal, without splitter/tap
<b>Product Series</b>	Mini-MST
<b>Product Brand</b>	DLX®
<b>Regional Availability</b>	EMEA

## General Specifications

<b>Distribution Type</b>	4 ports
<b>Port, quantity</b>	4
<b>Cable Type</b>	Armored - Round - Loose Tube
<b>Port Type</b>	Hardened mini-size DLX
<b>Stub Type</b>	Stub tail
<b>Cable, quantity</b>	1
<b>Enclosure Color</b>	Gray
<b>Package, quantity</b>	1
<b>Packaging Type</b>	Box   Carton
<b>Splitter, quantity</b>	0

## Dimensions

<b>Cable Length</b>	300.00 m   984.25 ft
<b>Depth</b>	58.70 mm   2.31 in
<b>Height</b>	214.80 mm   8.46 in
<b>Outer Cable Dimensions</b>	5.0 mm (0.20 in)
<b>Weight, without cable</b>	0.99 kg   2.18 lb
<b>Width</b>	150.00 mm   5.91 in

## Dimension Drawing

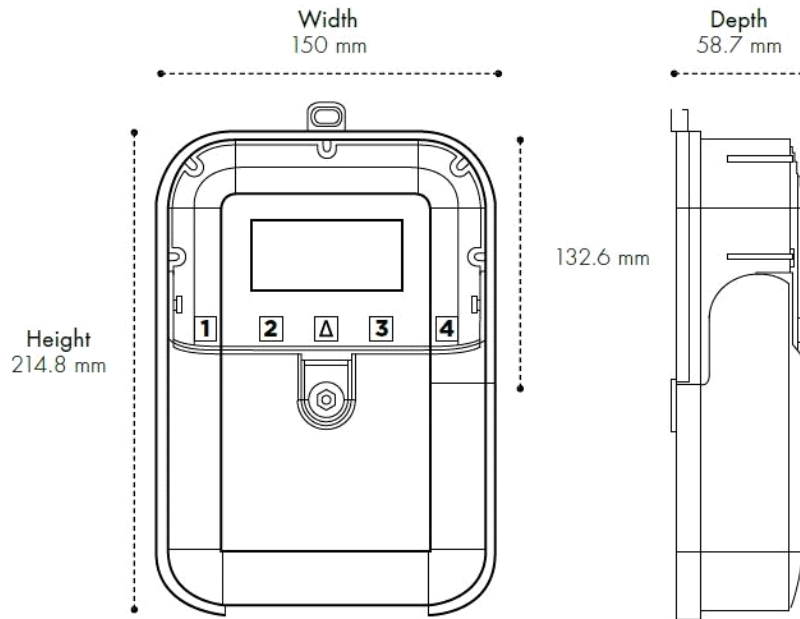

## Mechanical Specifications

<b>Enclosure Material Type</b>	Gasketed hardened plastic
<b>Mount Type</b>	Handhole   Wall

## Optical Specifications

<b>Fiber Type</b>	G.657.A1
<b>Insertion Loss, Terminal Connector, maximum</b>	0.40 dB
<b>Insertion Loss, Terminal Connector, typical</b>	0.16 dB
<b>Return Loss, Connector, minimum</b>	65 dB
<b>Wavelength Range</b>	1260–1635 nm

## Environmental Specifications

<b>Environmental Space</b>	Above ground   Below ground
<b>Operating Temperature</b>	-40 °C to +70 °C (-40 °F to +158 °F)
<b>Qualification Standard</b>	IEC 60529, IP65
<b>Relative Humidity</b>	5%–95%, non-condensing
<b>UV Resistance</b>	UV stabilized

## Regulatory Compliance/Certifications

**Agency**

RoHS 2011/65/EU  
ISO 9001:2015

**Classification**

Compliant  
Designed, manufactured and/or distributed under this quality management system

