

FST-R-04X00-G0250M



FST Flexible Service Terminal, 4 Port, 4 Mini-size (DLX) hardened Adapters at drop side, cable stub at feeder side, black, 250m long

- Flexible Service Terminals incorporate hardened connector technology that is designed to withstand the rugged outside plant environment
- Hardened connectors are factory-terminated and environmentally sealed for use in optical drop cable deployments
- Flexible structure plus very small branching unit, allowing installation in constrained spaces
- Output cables are staggered, optimizing distributed space consumption and minimizing cable kinking

Product Classification

Product Type	Access terminal, without splitter/tap
Product Series	FST-R
Product Brand	DLX®
Regional Availability	EMEA

General Specifications

Distribution Type	4 ports
Port, quantity	4
Cable Type	Dielectric - Loose Tube
Port Type	Hardened mini-size DLX
Stub Type	Stub tail
Enclosure Color	Black
Minimum Order Quantity	1
Package, quantity	1
Packaging Type	Box Carton
Splitter, quantity	0

Dimensions

Cable Length	250.00 m 820.21 ft
Outer Cable Dimensions	5.5 mm (0.22 in)

Dimension Drawing

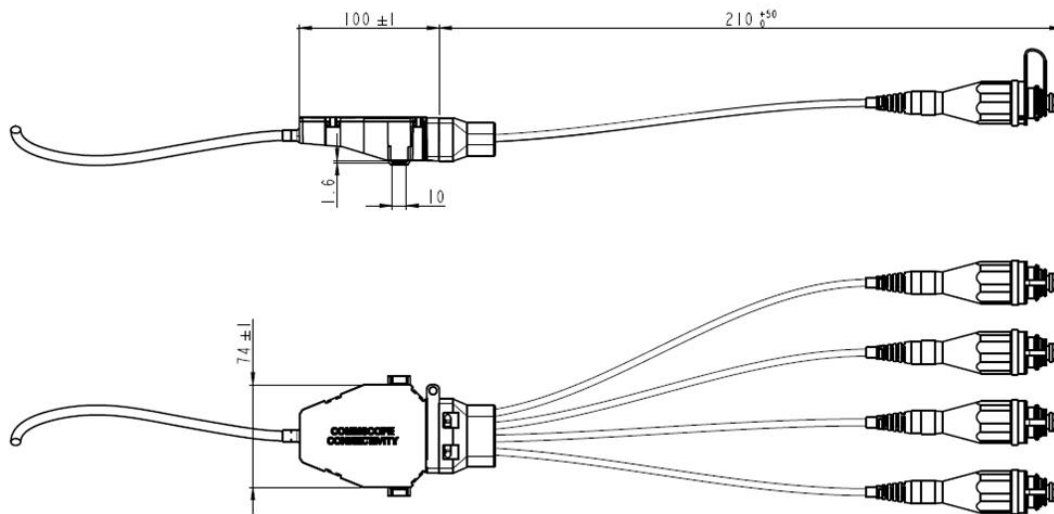

Mechanical Specifications

Enclosure Material Type	Engineered plastic
Mount Type	Handhole Pedestal

Optical Specifications

Fiber Type	G.657.A2
Insertion Loss, Terminal Connector, maximum	0.45 dB
Return Loss, Connector, minimum	60 dB
Wavelength Range	1310–1625 nm

Environmental Specifications

Environmental Space	Above ground Below ground Buried
Operating Temperature	-20 °C to +65 °C (-4 °F to +149 °F)
Qualification Standard	IEC 61753-1 Ed2 category G, IP68, 2 m waterhead
UV Resistance	UV stabilized

Regulatory Compliance/Certifications

Agency	Classification
RoHS 2011/65/EU	Compliant
ISO 9001:2015	Designed, manufactured and/or distributed under this quality management system

