

# EQ-HR1015

---

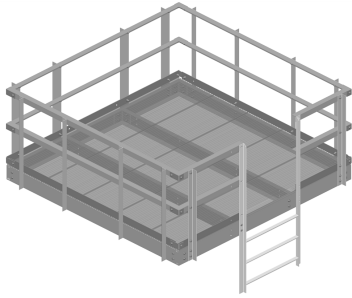

Handrail Kit for 10 ft x 15 ft equipment platform

## Product Classification

**Product Type** Equipment platform system

## Dimensions

**Length** 4.6 m | 15.0 ft  
**Width** 3.0 m | 10.0 ft  
**Height** 1219.2 mm | 48.0 in  
**Weight** 401.9 kg | 886.0 lb

## General Specifications

**Includes** Angle brackets | Hardware | Posts  
**Material Type** Hot dip galvanized steel  
**Mounting** EQ series platform bases  
**Package Quantity** 1

## Outline Drawing

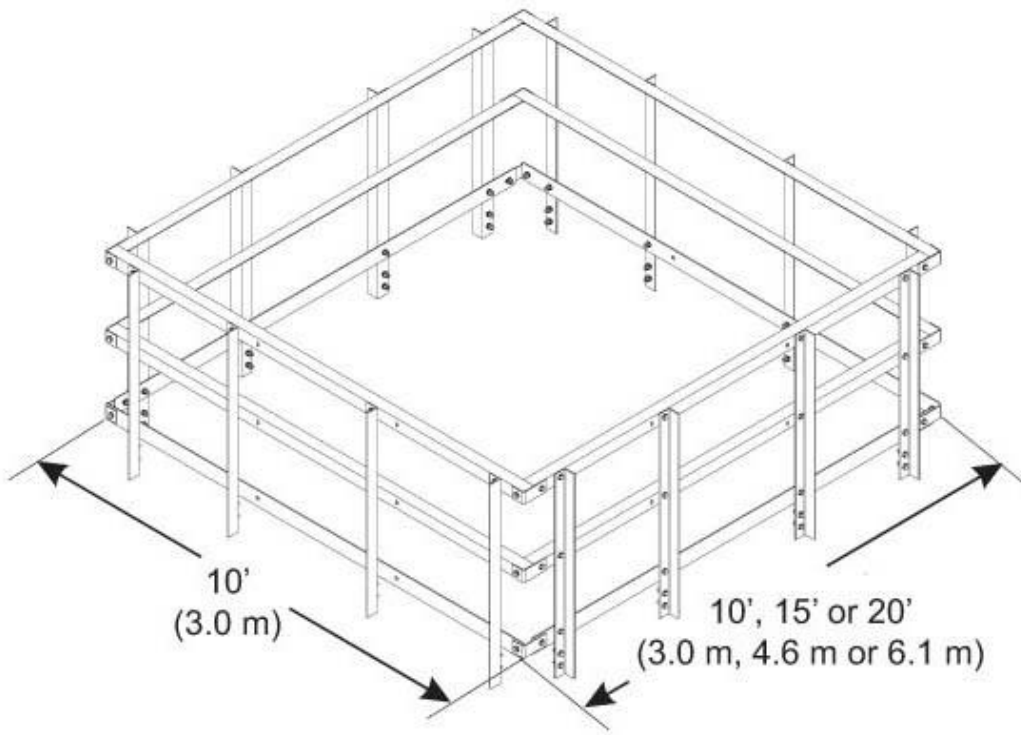

## Regulatory Compliance/Certifications

**Agency**

ISO 9001:2015

**Classification**

Designed, manufactured and/or distributed under this quality management system

