

Safety Grated Waveguide Bridge Kit, 24 in x 10 ft, with two 13 ft 4 in direct burial posts

Product Classification

Product Type Waveguide bridge kit

Dimensions

Height 4064.0 mm | 160.0 in

Length 3.0 m | 10.0 ft

Weight 174.6 kg | 385.0 lb

General Specifications

Application Direct burial

Cable Runs, quantity 24

Includes Caps | Channel | Hardware | Posts | Support brackets | Trapeze

Material Type Hot dip galvanized steel

Package Quantity 1

Pipe Length 4.1 m | 13.3 ft

Pipe, quantity 2

Outline Drawing

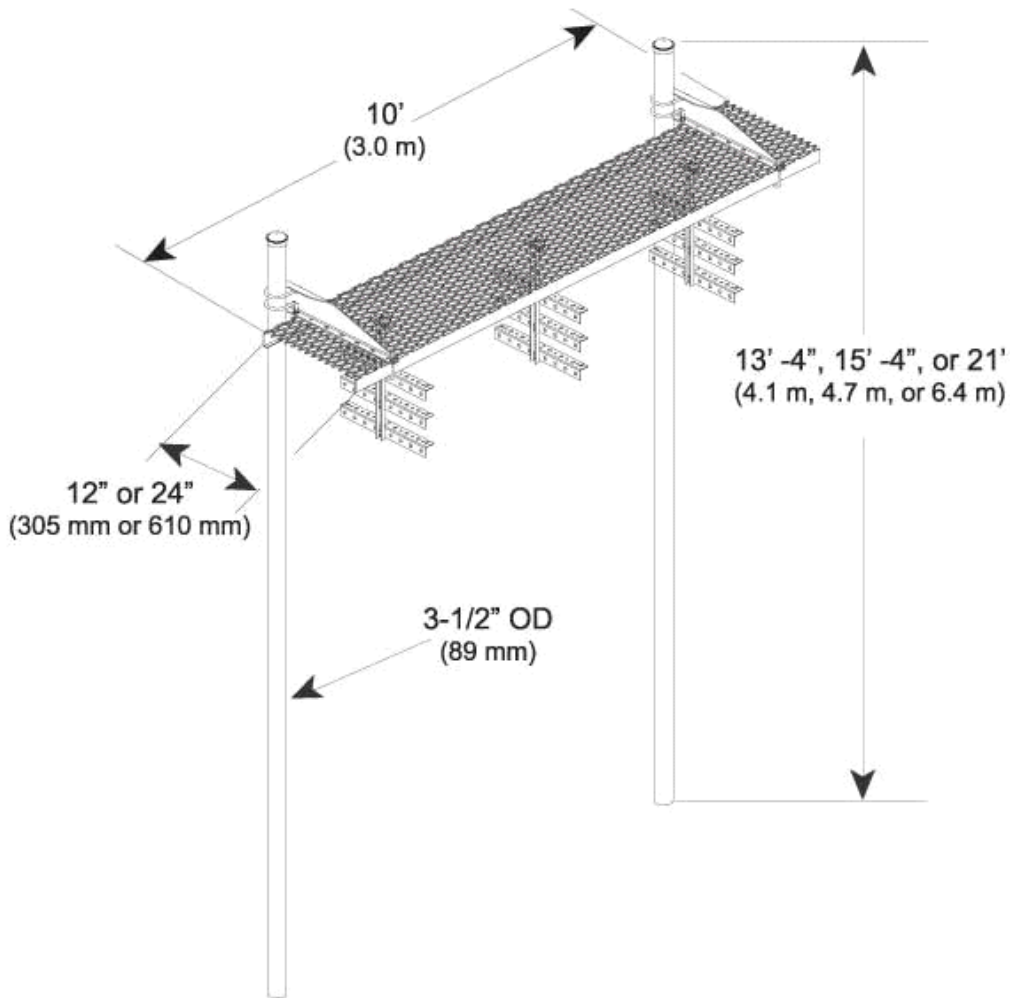

Regulatory Compliance/Certifications

Agency	Classification
ISO 9001:2015	Designed, manufactured and/or distributed under this quality management system



Included Products

WB-K210-B

WB-T24-3 — Trapeze Kit, triple tee, 24 in wide, three rungs

WB-LB24-3 — Waveguide Bridge Support Bracket, 24 in wide for 3-1/2 in OD legs

MF-130 — Direct Burial Pipe Column, 13 ft 4 in

WB-CY210 — Safety Grated Waveguide Bridge Channel, 24 in x 10 ft