

FID-LG-035M-01A-LG

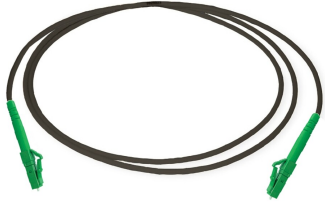

Fiber Optic Indoor/outdoor 3 mm Drop Cable Assembly, LC/APC-LC/APC, 35 M

Product Classification

Regional Availability	EMEA
Product Type	Fiber drop cable assembly
Product Series	FID
Ordering Note	For custom cable assembly lengths, please contact your local CommScope representative

General Specifications

Cable Type	Stapleable - Round
Connector A, quantity	1
Color, boot A	Green
Color, connector A	Green
Connector B, quantity	1
Color, boot B	Green
Color, connector B	Green
Interface, Connector A	LC/APC
Interface Feature, connector A	Male
Interface, Connector B	LC/APC
Interface Feature, connector B	Male
Jacket Color	Black
Total Fibers, quantity	1

Dimensions

Cable Assembly Length	35 m 114.829 ft
Cable Outer Diameter	3.0 mm (0.12 in)

Dimension Drawing

FID-LG-035M-01A-LG

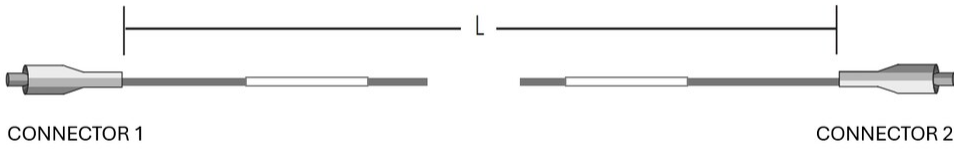

Ordering Tree

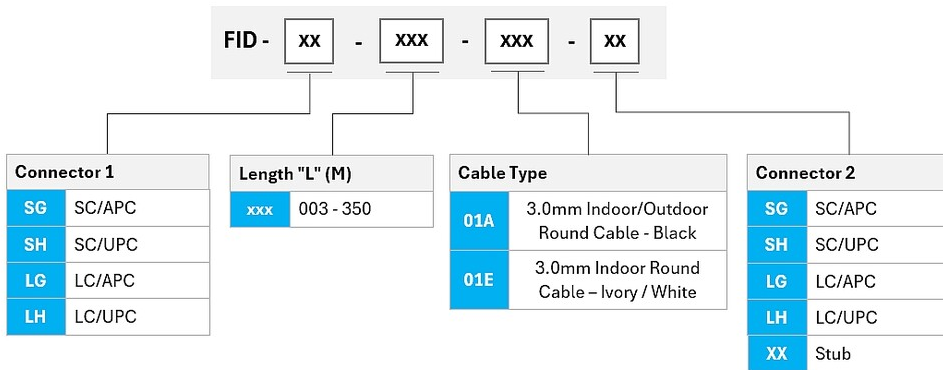

Representative Image

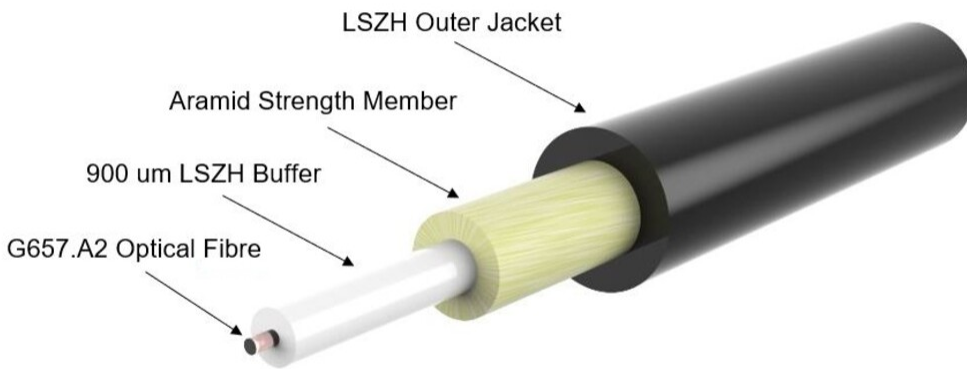

Material Specifications

FID-LG-035M-01A-LG

Jacket Material Low Smoke Zero Halogen (LSZH)

Mechanical Specifications

Minimum Bend Radius, loaded 50 mm | 1.969 in
Minimum Bend Radius, unloaded 30 mm | 1.181 in
Tensile Load, long term, maximum 30 N | 6.744 lbf
Tensile Load, short term, maximum 100 N | 22.481 lbf
Cable Crush Resistance, maximum 10 N/mm | 57.101 lb/in

Optical Specifications

Fiber Mode Singlemode
Fiber Type G.657.A2, TeraSPEED®
Insertion Loss, maximum, connector A 0.25 dB
Insertion Loss, maximum, connector B 0.25 dB
Return Loss, minimum, connector A 60 dB
Return Loss, minimum, connector B 60 dB

Environmental Specifications

Installation temperature -20 °C to +60 °C (-4 °F to +140 °F)
Operating Temperature -40 °C to +70 °C (-40 °F to +158 °F)
Storage Temperature -40 °C to +75 °C (-40 °F to +167 °F)
EN50575 CPR Cable EuroClass Fire Performance Dca
Environmental Space Indoor/Outdoor
Jacket UV Resistance UV stabilized
Qualification Standards IEC 60794-1-2

Packaging and Weights

Packaging quantity 1
Weight, net 0.37 kg | 0.816 lb

Regulatory Compliance/Certifications

Agency	Classification
CHINA-ROHS	Below maximum concentration value
REACH-SVHC	Compliant as per SVHC revision on www.commscope.com/ProductCompliance

FID-LG-035M-01A-LG

ROHS Compliant

UK-ROHS Compliant



Included Products

810010113/DB – Indoor/Outdoor Fiber Optic Drop cable, 1 Fiber G657 A2 0.9mm tight buffer. Breaking load Max 2000N. Suitable for installation under overhead power lines $\leq 11\text{kV}$, vertical clearance $\geq 1.8\text{m}$.
C-001-DN-8G1-M01BK/30D/D-UK00