

FID-SG-040M-01A-SG

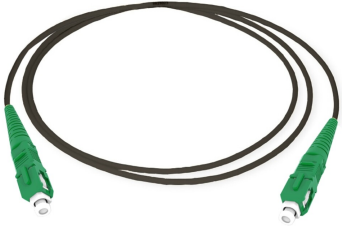

Fiber Optic Indoor/outdoor 3 mm Drop Cable Assembly, SC/APC-SC /APC, 40 M

Product Classification

| | |
|------------------------------|---|
| Regional Availability | EMEA |
| Product Type | Fiber drop cable assembly |
| Product Series | FID |
| Ordering Note | For custom cable assembly lengths, please contact your local CommScope representative |

General Specifications

| | |
|---------------------------------------|--------------------|
| Cable Type | Stapleable - Round |
| Connector A, quantity | 1 |
| Color, boot A | Green |
| Color, connector A | Green |
| Connector B, quantity | 1 |
| Color, boot B | Green |
| Color, connector B | Green |
| Interface, Connector A | SC/APC |
| Interface Feature, connector A | Male |
| Interface, Connector B | SC/APC |
| Interface Feature, connector B | Male |
| Jacket Color | Black |
| Total Fibers, quantity | 1 |

Dimensions

| | |
|------------------------------|-------------------|
| Cable Assembly Length | 40 m 131.234 ft |
| Cable Outer Diameter | 3.0 mm (0.12 in) |

Dimension Drawing

FID-SG-040M-01A-SG

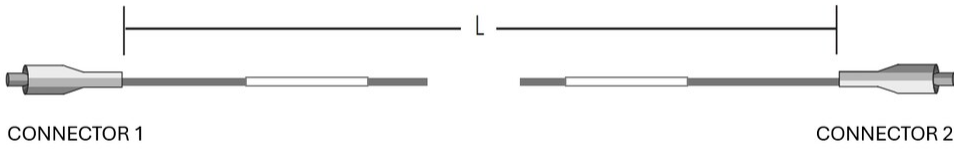

Ordering Tree

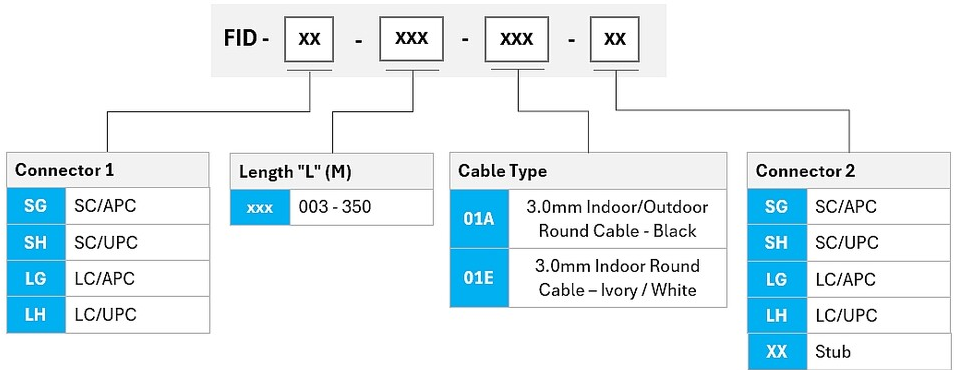

Representative Image

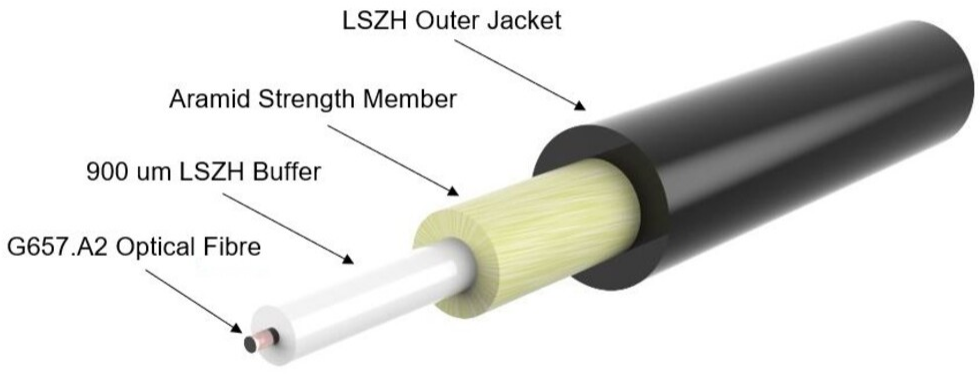

Material Specifications

FID-SG-040M-01A-SG

Jacket Material Low Smoke Zero Halogen (LSZH)

Mechanical Specifications

Minimum Bend Radius, loaded 50 mm | 1.969 in
Minimum Bend Radius, unloaded 30 mm | 1.181 in
Tensile Load, long term, maximum 30 N | 6.744 lbf
Tensile Load, short term, maximum 100 N | 22.481 lbf
Cable Crush Resistance, maximum 10 N/mm | 57.101 lb/in

Optical Specifications

Fiber Mode Singlemode
Fiber Type G.657.A2, TeraSPEED®
Insertion Loss, maximum, connector A 0.25 dB
Insertion Loss, maximum, connector B 0.25 dB
Return Loss, minimum, connector A 60 dB
Return Loss, minimum, connector B 60 dB

Environmental Specifications

Installation temperature -20 °C to +60 °C (-4 °F to +140 °F)
Operating Temperature -40 °C to +70 °C (-40 °F to +158 °F)
Storage Temperature -40 °C to +75 °C (-40 °F to +167 °F)
EN50575 CPR Cable EuroClass Fire Performance Dca
Environmental Space Indoor/Outdoor
Jacket UV Resistance UV stabilized
Qualification Standards IEC 60794-1-2

Packaging and Weights

Packaging quantity 1
Weight, net 0.42 kg | 0.926 lb

Regulatory Compliance/Certifications

| Agency | Classification |
|------------|--|
| CHINA-ROHS | Below maximum concentration value |
| REACH-SVHC | Compliant as per SVHC revision on www.commscope.com/ProductCompliance |

FID-SG-040M-01A-SG

ROHS Compliant

UK-ROHS Compliant



Included Products

810010113/DB – Indoor/Outdoor Fiber Optic Drop cable, 1 Fiber G657 A2 0.9mm tight buffer. Breaking load Max
C-001-DN-8G1-M01BK/30D/D-2000N. Suitable for installation under overhead power lines $\leq 11\text{kV}$, vertical clearance $\geq 1.8\text{m}$.
UK00

810010113/DB | C-001-DN-8G1-M01BK/30D/D-UK00

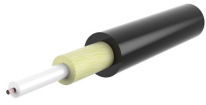

Indoor/Outdoor Fiber Optic Drop cable, 1 Fiber G657 A2 0.9mm tight buffer. Breaking load Max 2000N. Suitable for installation under overhead power lines $\leq 11\text{kV}$, vertical clearance $\geq 1.8\text{m}$.

Fire retardant Outside plant LSZH jacket grade, suitable for drop / aerial installations of up to 68 m. Can be routed indoor.

Product Classification

| | |
|------------------------------|---|
| Regional Availability | Asia Australia/New Zealand EMEA North America |
| Portfolio | CommScope® |
| Product Type | Fiber indoor/outdoor cable |

General Specifications

| | |
|-------------------------------------|--|
| Cable Type | Drop Tight buffer |
| Construction Type | All Dielectric Non-armored |
| Subunit Type | Gel-free |
| Jacket Color | Black |
| Jacket Marking | Meters |
| Jacket Marking Method | Inkjet |
| Jacket Marking Text | COMMSCOPE GB OPTICAL CABLE 810010113/DB 1x G657A2 SM LSZH [DOM] [SERIAL NUMBER] [METER MARK] |
| Subunit, quantity | 1 |
| Fibers per Subunit, quantity | 1 |
| Total Fiber Count | 1 |

Dimensions

| | |
|-------------------------------------|-------------------|
| Buffer Tube/Subunit Diameter | 0.9 mm 0.035 in |
| Diameter Over Jacket | 3 mm 0.118 in |

Representative Image

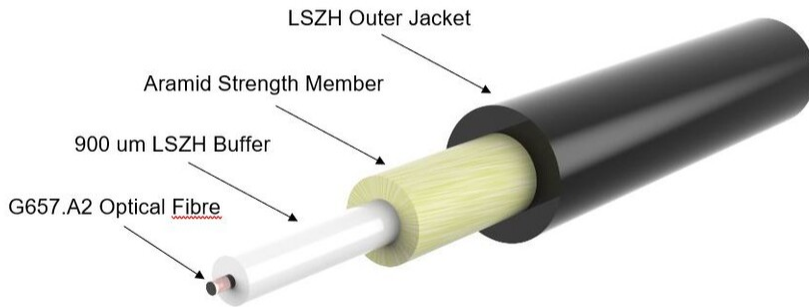

Material Specifications

Jacket Material Low Smoke Zero Halogen (LSZH)

Mechanical Specifications

| | |
|--|---------------------------------------|
| Minimum Bend Radius, loaded | 30 mm 1.181 in |
| Tensile Load, long term, maximum | 300 N 67.443 lbf |
| Tensile Load, short term, maximum | 620 N 139.382 lbf |
| Compression | 20 N/mm 114.203 lb/in |
| Compression Test Method | IEC 60794-1 E3 |
| Impact | 2 N-m 17.701 in lb |
| Impact Test Method | IEC 60794-1 E4 |
| Strain | See long and short term tensile loads |
| Strain Test Method | IEC 60794-1 E1 |
| Twist | 10 cycles |
| Twist Test Method | IEC 60794-1 E7 |

Optical Specifications

Fiber Type G.657.A2, TeraSPEED®

Environmental Specifications

| | |
|---|---|
| Installation temperature | -10 °C to +60 °C (+14 °F to +140 °F) |
| Operating Temperature | -30 °C to +65 °C (-22 °F to +149 °F) |
| Storage Temperature | -30 °C to +60 °C (-22 °F to +140 °F) |
| Cable Qualification Standards | IEC 60794-1-2 |
| EN50575 CPR Cable EuroClass Fire Performance | Dca |
| EN50575 CPR Cable EuroClass Smoke Rating | s1a |
| EN50575 CPR Cable EuroClass Droplets Rating | d0 |
| EN50575 CPR Cable EuroClass Acidity Rating | a1 |
| Environmental Space | Aerial Drop Ducted Indoor/Outdoor |
| Flame Test Listing | EN 50399 |
| Flame Test Method | IEC 60332-1-2 IEC 60754-2 IEC 61034-2 |
| Jacket UV Resistance | UV stabilized |
| Water Penetration | 24 h |
| Water Penetration Test Method | IEC 60794-1 F5 |

Environmental Test Specifications

| | |
|--------------------------------------|--------------------------------------|
| Temperature Cycle | -30 °C to +60 °C (-22 °F to +140 °F) |
| Temperature Cycle Test Method | IEC 60794-1-22 F1 |

Packaging and Weights

| | |
|---------------------|--------------------------|
| Cable weight | 8.7 kg/km 5.846 lb/kft |
|---------------------|--------------------------|

Regulatory Compliance/Certifications

| Agency | Classification |
|---------------|---|
| CHINA-ROHS | Below maximum concentration value |
| REACH-SVHC | Compliant as per SVHC revision on www.commscope.com/ProductCompliance |
| ROHS | Compliant |
| UK-ROHS | Compliant |



* Footnotes

Operating Temperature Specification applicable to non-terminated bulk fiber cable