

FID-SG-050M-01A-XX

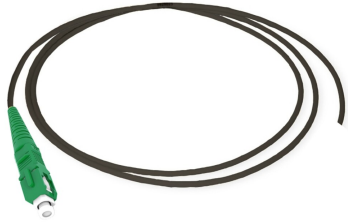

Fiber Optic Indoor/outdoor 3 mm Drop Cable Stub Assembly, SC/APC, 50 M

Product Classification

Regional Availability	EMEA
Product Type	Fiber drop cable assembly
Product Series	FID
Ordering Note	For custom cable assembly lengths, please contact your local CommScope representative

General Specifications

Cable Type	Stapleable - Round
Connector A, quantity	1
Color, boot A	Green
Color, connector A	Green
Interface, Connector A	SC/APC
Interface Feature, connector A	Male
Interface, Connector B	Unterminated
Jacket Color	Black
Total Fibers, quantity	1

Dimensions

Cable Assembly Length	50 m 164.042 ft
Cable Outer Diameter	3.0 mm (0.12 in)

Dimension Drawing

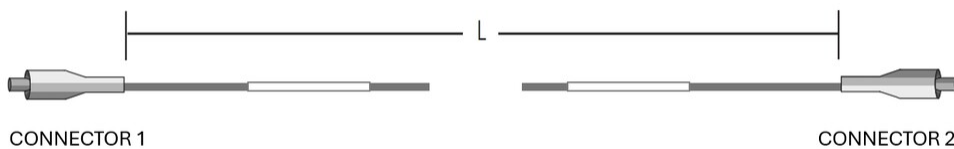

FID-SG-050M-01A-XX

Ordering Tree

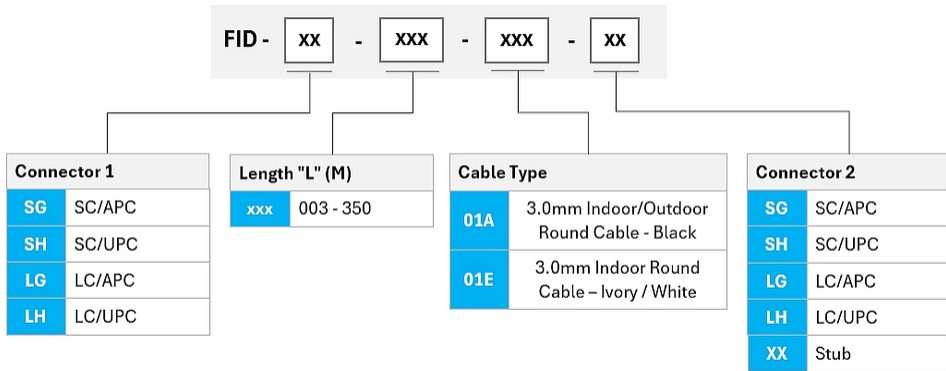

Representative Image

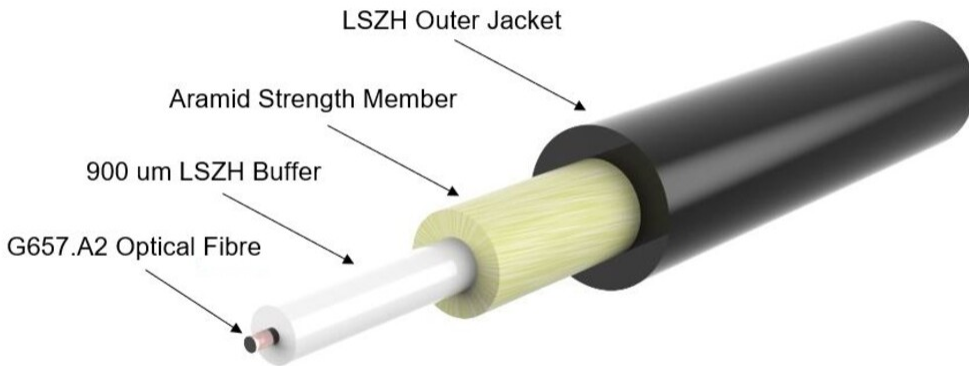

Material Specifications

Jacket Material Low Smoke Zero Halogen (LSZH)

Mechanical Specifications

Minimum Bend Radius, loaded 50 mm | 1.969 in

Minimum Bend Radius, unloaded 30 mm | 1.181 in

FID-SG-050M-01A-XX

Tensile Load, long term, maximum	30 N 6.744 lbf
Tensile Load, short term, maximum	100 N 22.481 lbf
Cable Crush Resistance, maximum	10 N/mm 57.101 lb/in

Optical Specifications

Fiber Mode	Singlemode
Fiber Type	G.657.A2, TeraSPEED®
Insertion Loss, maximum, connector A	0.25 dB
Return Loss, minimum, connector A	60 dB

Environmental Specifications

Installation temperature	-20 °C to +60 °C (-4 °F to +140 °F)
Operating Temperature	-40 °C to +70 °C (-40 °F to +158 °F)
Storage Temperature	-40 °C to +75 °C (-40 °F to +167 °F)
EN50575 CPR Cable EuroClass Fire Performance	Dca
Environmental Space	Indoor/Outdoor
Jacket UV Resistance	UV stabilized
Qualification Standards	IEC 60794-1-2

Packaging and Weights

Packaging quantity	1
Weight, net	0.5 kg 1.102 lb

Regulatory Compliance/Certifications

Agency	Classification
CHINA-ROHS	Below maximum concentration value
REACH-SVHC	Compliant as per SVHC revision on www.commscope.com/ProductCompliance
ROHS	Compliant
UK-ROHS	Compliant



Included Products

810010113/DB C-001-DN-8G1-M01BK/30D/D-	–	Indoor/Outdoor Fiber Optic Drop cable, 1 Fiber G657 A2 0.9mm tight buffer. Breaking load Max 2000N. Suitable for installation under overhead power lines ≤11kV, vertical clearance ≥1.8m.
---	---	---

FID-SG-050M-01A-XX

UK00

810010113/DB | C-001-DN-8G1-M01BK/30D/D-UK00

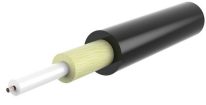

Indoor/Outdoor Fiber Optic Drop cable, 1 Fiber G657 A2 0.9mm tight buffer. Breaking load Max 2000N. Suitable for installation under overhead power lines $\leq 11\text{kV}$, vertical clearance $\geq 1.8\text{m}$.

Fire retardant Outside plant LSZH jacket grade, suitable for drop / aerial installations of up to 68 m. Can be routed indoor.

Product Classification

Regional Availability	Asia Australia/New Zealand EMEA North America
Portfolio	CommScope®
Product Type	Fiber indoor/outdoor cable

General Specifications

Cable Type	Drop Tight buffer
Construction Type	All Dielectric Non-armored
Subunit Type	Gel-free
Jacket Color	Black
Jacket Marking	Meters
Jacket Marking Method	Inkjet
Jacket Marking Text	COMMSCOPE GB OPTICAL CABLE 810010113/DB 1x G657A2 SM LSZH [DOM] [SERIAL NUMBER] [METER MARK]
Subunit, quantity	1
Fibers per Subunit, quantity	1
Total Fiber Count	1

Dimensions

Buffer Tube/Subunit Diameter	0.9 mm 0.035 in
Diameter Over Jacket	3 mm 0.118 in

Representative Image

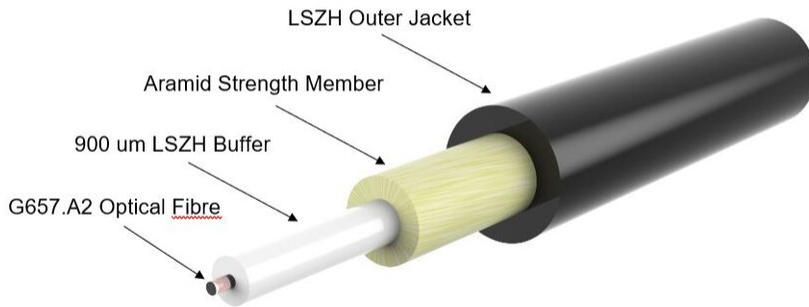

Material Specifications

Jacket Material Low Smoke Zero Halogen (LSZH)

Mechanical Specifications

Minimum Bend Radius, loaded	30 mm 1.181 in
Tensile Load, long term, maximum	300 N 67.443 lbf
Tensile Load, short term, maximum	620 N 139.382 lbf
Compression	20 N/mm 114.203 lb/in
Compression Test Method	IEC 60794-1 E3
Impact	2 N-m 17.701 in lb
Impact Test Method	IEC 60794-1 E4
Strain	See long and short term tensile loads
Strain Test Method	IEC 60794-1 E1
Twist	10 cycles
Twist Test Method	IEC 60794-1 E7

Optical Specifications

Fiber Type G.657.A2, TeraSPEED®

Environmental Specifications

Installation temperature	-10 °C to +60 °C (+14 °F to +140 °F)
Operating Temperature	-30 °C to +65 °C (-22 °F to +149 °F)
Storage Temperature	-30 °C to +60 °C (-22 °F to +140 °F)
Cable Qualification Standards	IEC 60794-1-2
EN50575 CPR Cable EuroClass Fire Performance	Dca
EN50575 CPR Cable EuroClass Smoke Rating	s1a
EN50575 CPR Cable EuroClass Droplets Rating	d0
EN50575 CPR Cable EuroClass Acidity Rating	a1
Environmental Space	Aerial Drop Ducted Indoor/Outdoor
Flame Test Listing	EN 50399
Flame Test Method	IEC 60332-1-2 IEC 60754-2 IEC 61034-2
Jacket UV Resistance	UV stabilized
Water Penetration	24 h
Water Penetration Test Method	IEC 60794-1 F5

Environmental Test Specifications

Temperature Cycle	-30 °C to +60 °C (-22 °F to +140 °F)
Temperature Cycle Test Method	IEC 60794-1-22 F1

Packaging and Weights

Cable weight	8.7 kg/km 5.846 lb/kft
---------------------	--------------------------

Regulatory Compliance/Certifications

Agency	Classification
CHINA-ROHS	Below maximum concentration value
REACH-SVHC	Compliant as per SVHC revision on www.commscope.com/ProductCompliance
ROHS	Compliant
UK-ROHS	Compliant



* Footnotes

Operating Temperature Specification applicable to non-terminated bulk fiber cable