

FID-SG-050M-01A-XX

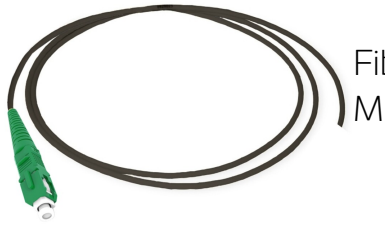

Fiber Optic Indoor/outdoor 3 mm Drop Cable Stub Assembly, SC/APC, 50 M

Product Classification

Regional Availability	EMEA
Product Type	Fiber drop cable assembly
Product Series	FID
Ordering Note	For custom cable assembly lengths, please contact your local CommScope representative

General Specifications

Cable Type	Stapleable - Round
Connector A, quantity	1
Color, boot A	Green
Color, connector A	Green
Interface, Connector A	SC/APC
Interface Feature, connector A	Male
Interface, Connector B	Unterminated
Jacket Color	Black
Total Fibers, quantity	1

Dimensions

Cable Assembly Length	50 m 164.042 ft
Cable Outer Diameter	3.0 mm (0.12 in)

Dimension Drawing

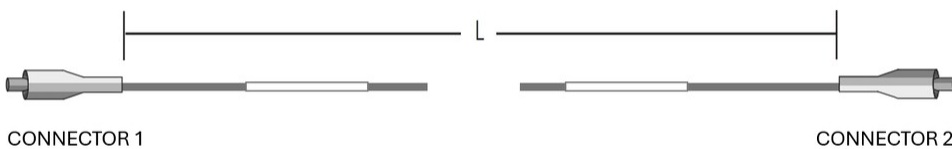

FID-SG-050M-01A-XX

Ordering Tree

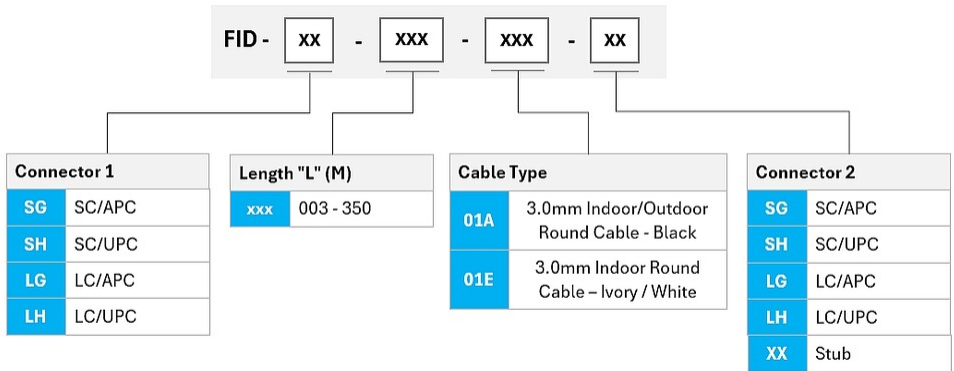

Representative Image

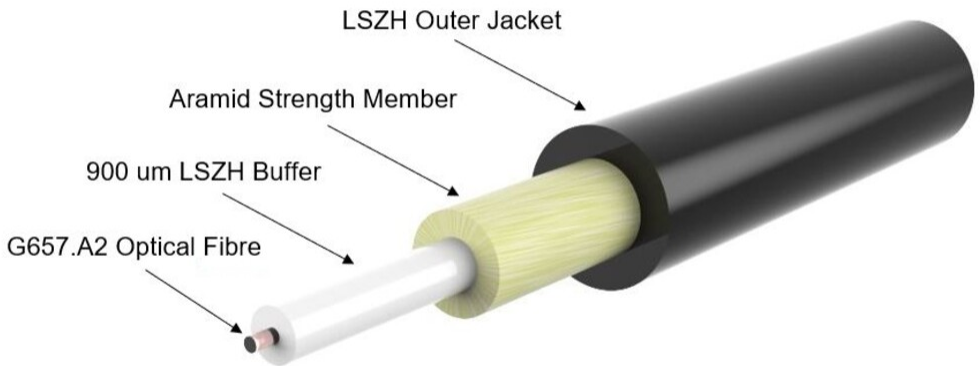

Material Specifications

Jacket Material Low Smoke Zero Halogen (LSZH)

Mechanical Specifications

Minimum Bend Radius, loaded 50 mm | 1.969 in

Minimum Bend Radius, unloaded 30 mm | 1.181 in

FID-SG-050M-01A-XX

Tensile Load, long term, maximum	30 N 6.744 lbf
Tensile Load, short term, maximum	100 N 22.481 lbf
Cable Crush Resistance, maximum	10 N/mm 57.101 lb/in

Optical Specifications

Fiber Mode	Singlemode
Fiber Type	G.657.A2, TeraSPEED®
Insertion Loss, maximum, connector A	0.25 dB
Return Loss, minimum, connector A	60 dB

Environmental Specifications

Installation temperature	-20 °C to +60 °C (-4 °F to +140 °F)
Operating Temperature	-40 °C to +70 °C (-40 °F to +158 °F)
Storage Temperature	-40 °C to +75 °C (-40 °F to +167 °F)
EN50575 CPR Cable EuroClass Fire Performance	Dca
Environmental Space	Indoor/Outdoor
Jacket UV Resistance	UV stabilized
Qualification Standards	IEC 60794-1-2

Packaging and Weights

Packaging quantity	1
Weight, net	0.5 kg 1.102 lb

Regulatory Compliance/Certifications

Agency	Classification
CHINA-ROHS	Below maximum concentration value
REACH-SVHC	Compliant as per SVHC revision on www.commscope.com/ProductCompliance
ROHS	Compliant
UK-ROHS	Compliant



Included Products

810010113/DB C-001-DN-8G1-M01BK/30D/D-	–	Indoor/Outdoor Fiber Optic Drop cable, 1 Fiber G657 A2 0.9mm tight buffer. Breaking load Max 2000N. Suitable for installation under overhead power lines ≤11kV, vertical clearance ≥1.8m.
---	---	---

FID-SG-050M-01A-XX

UK00