

# MST-04XX00-B0500U



DLX® Mini-MST, Fiber Optic Multiport Service Terminal, 4-port, locatable flat loose tube cable, 500 ft

- Hardened connectors are factory-terminated and environmentally sealed for use in optical drop cable deployments
- Plug and play adapter ports ensure rapid cable installment in the outside plant access section of the network
- Multiport Service Terminals incorporate hardened connector technology that is designed to withstand the rugged outside plant environment

## Product Classification

<b>Regional Availability</b>	Asia   Latin America   North America
<b>Product Type</b>	Access terminal, without splitter/tap
<b>Product Brand</b>	DLX®
<b>Product Series</b>	Mini-MST

## General Specifications

<b>Cable Type</b>	Locatable - Flat - Loose Tube
<b>Cable, quantity</b>	1
<b>Distribution Type</b>	4 ports
<b>Enclosure Color</b>	Black
<b>Mounting</b>	Handhole   Pedestal   Pole   Strand
<b>Port Type</b>	Hardened mini-size DLX
<b>Port, quantity</b>	4
<b>Splitter, quantity</b>	0
<b>Stub Type</b>	Stub tail

## Dimensions

<b>Height</b>	298 mm   11.732 in
<b>Width</b>	130.3 mm   5.13 in
<b>Depth</b>	89 mm   3.504 in
<b>Cable Length, stub</b>	500 ft (152 m)
<b>Cable Outer Diameter</b>	5.0 mm (0.20 in)

# MST-04XX00-B0500U

## Dimension Drawing

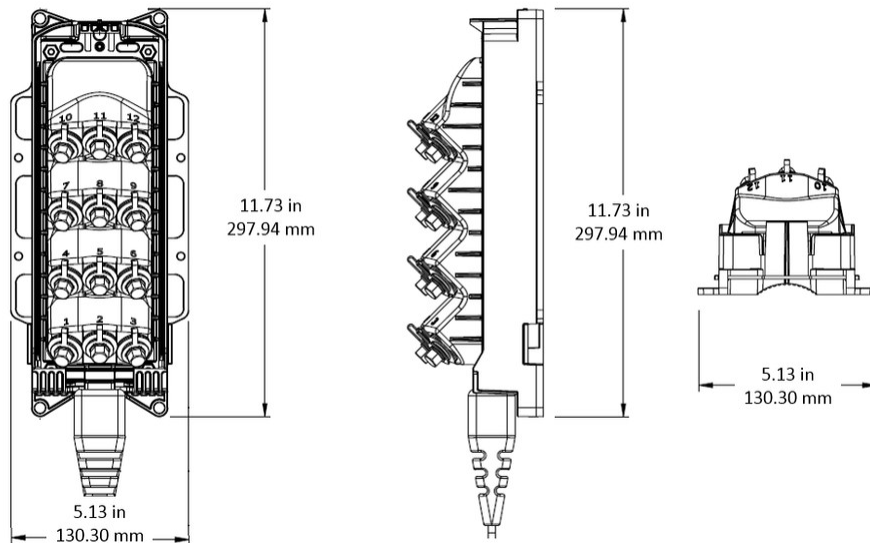

## Ordering Tree

MST -  X  -  -  -  -

### Terminal model

02	2 ports
04	4 ports
06	6 ports
08	8 ports
12	12 ports
0N	1 x 4 splitter
0J	1 x 8 splitter
0W	1 x 2 splitter

### Cable termination

00	Pigtail (No connector)
X0	DLX connector (only available on splitter terminals)

### Cable type

A	Dielectric, flat, loose tube (44.3mm x 8.0mm)
B	Locatable/tonable, flat, loose tube (44.3mm x 10.0mm)

### Mounting style\*

U	Universal: Terminal is on top of the spool; stub deploys first
A	Reversal Spool: Terminal is on the bottom of the spool; terminal deploys first

\*0-300 ft lengths of cable is automatically coiled (option U), for lengths greater than 300 feet choose U or A option.

### Standard cable stub length

0050	50 feet	1000	1,000 feet
0100	100 feet	1250	1,250 feet
0250	250 feet	1500	1,500 feet
0500	500 feet	1750	1,750 feet
0750	750 feet	2000	2,000 feet

Standard lengths shown; metric lengths available

## Material Specifications

### Enclosure Material Type

Gasketed hardened plastic

## Optical Specifications

### Fiber Type

G.657.A1/A2

# MST-04XX00-B0500U

<b>Operating Wavelength Range</b>	1260 – 1635 nm
<b>Attenuation Cable Coefficient, maximum</b>	0.30 dB/km @ 1550 nm   0.40 dB/km @ 1310 nm
<b>Attenuation Terminal Connectors, maximum</b>	0.4 dB
<b>Directivity, minimum</b>	60 dB
<b>Insertion Loss, Terminal Connector, typical</b>	0.16 dB
<b>Return Loss, Connector, minimum</b>	65 dB

## Environmental Specifications

<b>Operating Temperature</b>	-40 °C to +70 °C (-40 °F to +158 °F)
<b>Relative Humidity</b>	5%–100%, condensing
<b>Environmental Space</b>	Above ground   Below ground   Buried
<b>Flammability Rating</b>	UL 94 V-0
<b>Qualification Standards</b>	IEC 60529, IP68 + 2 m waterhead   Telcordia GR-3120-CORE   Telcordia GR-326-CORE   Telcordia GR-771-CORE
<b>UV Resistance</b>	UV stabilized

## Packaging and Weights

<b>Included</b>	Enclosure (1)   Universal mounting bracket (1)
<b>Packaging quantity</b>	1
<b>Packaging Type</b>	Box   Carton
<b>Weight, without cable</b>	0.99 kg   2.183 lb

## Regulatory Compliance/Certifications

<b>Agency</b>	<b>Classification</b>
CHINA-ROHS	Below maximum concentration value
ISO 9001:2015	Designed, manufactured and/or distributed under this quality management system
REACH-SVHC	Compliant as per SVHC revision on <a href="http://www.commscope.com/ProductCompliance">www.commscope.com/ProductCompliance</a>
ROHS	Compliant
UK-ROHS	Compliant



## Included Products

MST-UMB-MINI – DLX® Mini-MST, Fiber Optic Universal Mounting

# MST-04XX00-B0500U

---

Bracket