



FACT® Fiber Optic Patch Chassis, gray, 4E high, 192-port, multimode, OM4, holding 8 hinged trays loaded with LC/UPC adapters

- Designed for use with the all-purpose all-front-access FIST-GR3 fiber frames supporting up to 2,688 LC or 1,344 SC connections in a single frame
- Reduced installation and maintenance time via the toolless snap-on design supporting both interconnect and cross-connect applications
- Flexible customization enabled by 4 chassis types (patch-only, patch-splice, pre-cabled and splice-only) to support all ODF applications
- High density through the single FACT element height (1E) being 30% less tall compared to the industry standard panel height (1HU)

## Product Classification

<b>Regional Availability</b>	Asia   Australia/New Zealand   EMEA   Latin America   North America
<b>Portfolio</b>	CommScope®
<b>Product Type</b>	Fiber patch chassis
<b>Product Brand</b>	FACT®
<b>Product Series</b>	FACT

## General Specifications

<b>Functionality</b>	Patching
<b>Application</b>	Compatible with FIST-GR3-style frames
<b>Body Style</b>	Symmetrical
<b>Color</b>	Gray
<b>Growth Configuration</b>	Fully loaded
<b>Interface, front</b>	LC/UPC
<b>Patch Cord Routing</b>	Left sided   Right sided
<b>Rack Type</b>	EIA 19 in
<b>Rack Units</b>	2.8
<b>Shelf Movement</b>	Sliding
<b>Total Ports, quantity</b>	192
<b>Transmission Standards</b>	ETSI EN 300 019-1-3   IEC 61300-3-30

## Dimensions

<b>Height</b>	123.8 mm   4.874 in
---------------	---------------------

# 760239995 | FACT-4EPATL4

**Width** 524 mm | 20.63 in

**Depth** 283 mm | 11.142 in

## Ordering Tree

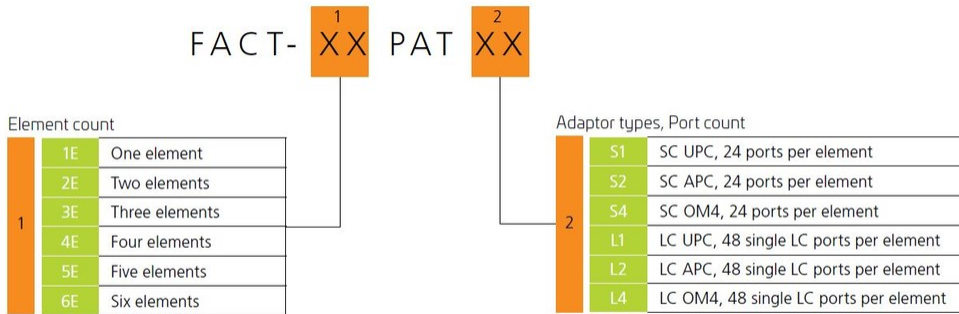

## Optical Specifications

**Fiber Mode** Multimode

**Fiber Type** OM4

## Environmental Specifications

**Operating Temperature** -40 °C to +70 °C (-40 °F to +158 °F)

**Storage Temperature** -20 °C to +85 °C (-4 °F to +176 °F)

**Flammability Rating** UL 94 V-0

## Packaging and Weights

**Included** Mounting hardware

**Packaging quantity** 1

## Regulatory Compliance/Certifications

Agency	Classification
CHINA-ROHS	Below maximum concentration value
ISO 9001:2015	Designed, manufactured and/or distributed under this quality management system
REACH-SVHC	Compliant as per SVHC revision on <a href="http://www.commscope.com/ProductCompliance">www.commscope.com/ProductCompliance</a>
ROHS	Compliant
UK-ROHS	Compliant

