



FOSC® 450 A4 Fiber Optic Splice Closure with one 2-port tap, 5 dB

- Single-ended, O-ring sealed dome closure for splicing feeder and distribution cables
- Gel cable sealing technology allows easy adding or removing of a wide size range of cables
- Compatible with most common cable types: e.g. loose tube, central core, ribbon fiber
- FOSC splice trays hinged for access to any splice without disturbing other trays
- Closure can be used in aerial, pedestal and underground (up to 5 meters) environments
- Compatible with CommScope's CWDM modules and optical splitter trays

Product Classification

Regional Availability	Latin America North America
Product Type	Single-ended, round fiber closure
Product Brand	FOSC®
Product Series	FOSC 450

General Specifications

Cable Entry Drop Port Style	Round
Cable Entry Main Port Style	Round
Cable Ports Quantity, total	4 round ports
Cable Sealing Type	Compressed gel
Closure Sealing Type	Dome-to-base clamp with O-ring
Closure Style	Single-ended
Color	Black
Flash Test Valve	None
Ground Feed-through	None
Mounting	Pole Strand Wall
Network Area Type	Drop
Splice Tray Included, quantity	1
Splice Tray Type Included	12-way, heat shrink
Splicing Capacity, Mass Fusion, maximum	144
Splicing Capacity, Single Fusion, maximum	96
Splicing Capacity, Single Splice, 12 fibers, maximum	96
Splicing Capacity, Single Splice, 6 fibers, maximum	48

221981-000 | FOSC450-A4-4-TAP-2P-05

Splicing Type, Supported

Mass fusion | Single fusion

Dimensions

Length

485 mm | 19.094 in

Diameter

150 mm | 5.906 in

Diameter, with clamp

205 mm | 8.071 in

Main Cable Diameter, maximum

25 mm | 0.984 in

Dimension Drawing

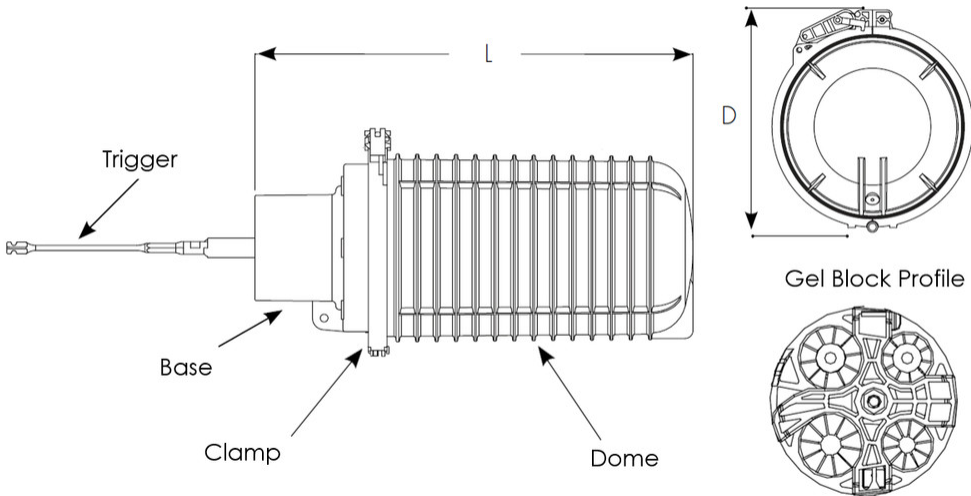

Ordering Tree

FOSC 450 - A4 - TAP - XX - XX

Tap Tray Configuration

2P	2-port tap tray
4P	4-port tap tray
8P	8-port tap tray

Tap Value and Type

04T	4 dB, terminating tap
05	5 dB, non-terminating tap
07	7 dB, non-terminating tap
07T	7 dB, terminating tap
08	8 dB, non-terminating tap
09	9 dB, non-terminating tap
10	10 dB, non-terminating tap
11	11 dB, non-terminating tap
11T	11 dB, terminating tap
12	12 dB, non-terminating tap
13	13 dB, non-terminating tap
14	14 dB, non-terminating tap
15	15 dB, non-terminating tap
17	17 dB, non-terminating tap
19	19 dB, non-terminating tap
21	21 dB, non-terminating tap

Material Specifications

Material Type Impact-resistant polymer

Environmental Specifications

Environmental Space Below ground | Buried

Qualification Standards IEC 61300, 5 m waterhead

Water Resistance Flash test valve at 5 psi (40 kPa)

Packaging and Weights

Packaging quantity 1

Packaging Type Box | Carton

Weight, net 2.72 kg | 5.997 lb

Regulatory Compliance/Certifications

Agency	Classification
CHINA-ROHS	Below maximum concentration value

221981-000 | FOSC450-A4-4-TAP-2P-05

ISO 9001:2015	Designed, manufactured and/or distributed under this quality management system
REACH-SVHC	Compliant as per SVHC revision on www.commscope.com/ProductCompliance
ROHS	Compliant
UK-ROHS	Compliant

