

MST-12RHMO-A0330UM

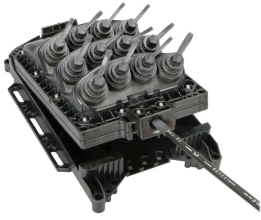

MST, Fiber Optic Multiport Service Terminal, 12-port, square 4x3 port, HMFOC connector tail, dielectric flat loose tube cable, 330 m

- Hardened connectors are factory-terminated and environmentally sealed for use in optical drop cable deployments
- Plug and play adapter ports ensure rapid cable installment in the outside plant access section of the network
- Multiport Service Terminals incorporate hardened connector technology that is designed to withstand the rugged outside plant environment

Product Classification

Regional Availability	Asia Latin America North America
Product Type	Access terminal, without splitter/tap
Product Series	MST

General Specifications

Cable Type	Dielectric - Flat - Loose Tube
Cable, quantity	1
Distribution Type	12 ports
Enclosure Color	Black
Mounting	Handhole Pedestal Pole Strand
Port Type	Hardened full-size SC/APC
Port, quantity	12
Splitter, quantity	0
Stub Type	Hardened multi-fiber (HMFOC) plug

Dimensions

Height	286 mm 11.26 in
Width	188 mm 7.402 in
Depth	92.1 mm 3.626 in
Cable Length, stub	1083 ft (330 m)
Cable Outer Diameter	4.5 x 8.1 mm (0.18 x 0.32 in)

Dimension Drawing

MST-12RHMO-A0330UM

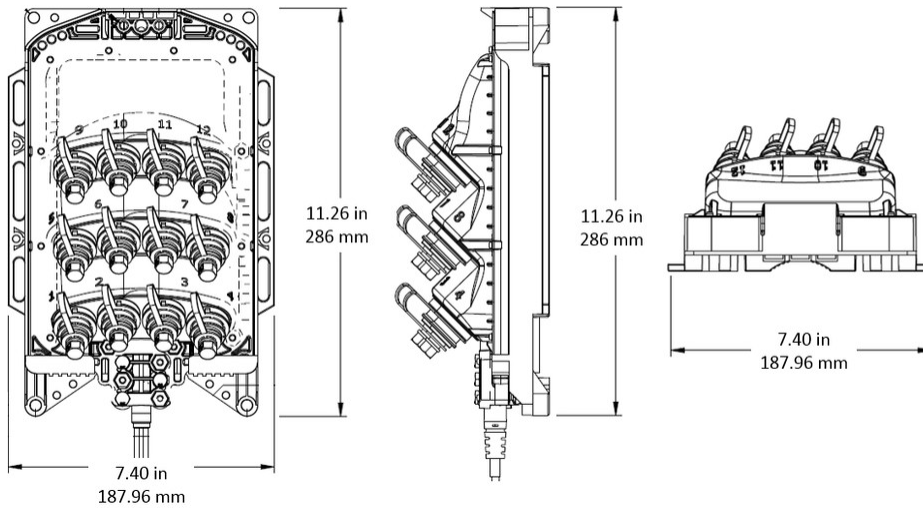

Material Specifications

Enclosure Material Type

Gasketed hardened plastic

Optical Specifications

Fiber Type

G.657.A1/A2

Operating Wavelength Range

1260 – 1635 nm

Attenuation Cable Coefficient, maximum

0.30 dB/km @ 1550 nm | 0.40 dB/km @ 1310 nm

Attenuation Terminal Connectors, maximum

0.4 dB

Directivity, minimum

60 dB

Insertion Loss, Stub Connector, maximum

0.45 dB

Insertion Loss, Stub Connector, typical

0.16 dB

Insertion Loss, Terminal Connector, typical

0.16 dB

Return Loss, Connector, minimum

65 dB

Environmental Specifications

Operating Temperature

-40 °C to +70 °C (-40 °F to +158 °F)

Relative Humidity

5%–100%, condensing

Environmental Space

Above ground | Below ground | Buried

Flammability Rating

UL 94 5VA

Qualification Standards

IEC 60529, IP68 + 2 m waterhead | Telcordia GR-3120-CORE | Telcordia GR-326-CORE | Telcordia GR-771-CORE

MST-12RHMO-A0330UM

UV Resistance

UV stabilized

Packaging and Weights

Included

Enclosure (1) | Universal mounting bracket (1)

Packaging quantity

1

Packaging Type

Box | Carton

Weight, without cable

1.36 kg | 2.998 lb

Regulatory Compliance/Certifications

Agency**Classification**

CHINA-ROHS

Below maximum concentration value

ISO 9001:2015

Designed, manufactured and/or distributed under this quality management system

REACH-SVHC

Compliant as per SVHC revision on www.commscope.com/ProductCompliance

ROHS

Compliant

UK-ROHS

Compliant



Included Products

MST-UMB-4312 – Universal MST Mounting Bracket

MST-UMB-4312



Universal MST Mounting Bracket

Product Classification

Regional Availability	EMEA Latin America North America
Product Type	Mounting bracket
Product Series	MST NDX

General Specifications

Color	Black
--------------	-------

Environmental Specifications

Environmental Space	Outdoor
----------------------------	---------

Packaging and Weights

Packaging quantity	1
Packaging Type	Bag Carton

Regulatory Compliance/Certifications

Agency	Classification
CHINA-ROHS	Below maximum concentration value
REACH-SVHC	Compliant as per SVHC revision on www.commscope.com/ProductCompliance
ROHS	Compliant
UK-ROHS	Compliant

