

NDX-10BTMOU-A1750F



DLX® Fiber Indexing Terminal, 1x8 Splitter, 8 Forward Ports, 1 Reverse Port, Dielectric Flat Loose Tube Cable, 1750 Feet

- Fiber Indexing terminals are access terminals using hardened connectivity technology that withstand the rugged outside plant environment
- Fiber Indexing terminals eliminate splicing and use 12-strand fiber cable in a daisy-chain topology, reducing the total required cable length by up to 70%
- Hardened adapters are factory-terminated and environmentally sealed to ensure rapid plug-and-play drop cable installations

Product Classification

Regional Availability	North America
Product Type	Access terminal, indexed with splitter
Product Brand	DLX®
Product Series	NDX

General Specifications

Cable Type	Dielectric - Flat - Loose Tube
Cable, quantity	1
Distribution Type	1 x 8 splitter
Enclosure Color	Black
Forward Port Type	Hardened mini-size (DLX) adapter
Forward Port, quantity	8
Mounting	Handhole Pedestal Pole
Port Type	Hardened multi-fiber (HMFOC) jack, male/pinned
Port, quantity	1
Reverse Port Type	Hardened mini-size DLX
Reverse Port, quantity	1
Splitter, quantity	1
Stub Type	Hardened multi-fiber (HMFOC) plug

Dimensions

Height	297.8 mm 11.724 in
Width	130.3 mm 5.13 in

NDX-10BTMOU-A1750F

Depth	90.4 mm 3.559 in
Cable Length, stub	1750 ft (533 m)
Cable Outer Diameter	4.5 x 8.1 mm (0.18 x 0.32 in)

Dimension Drawing

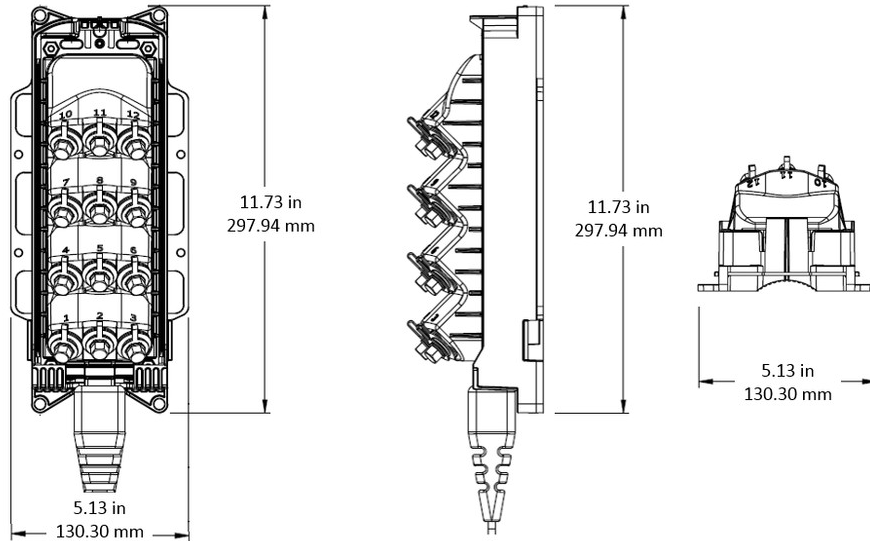

Ordering Tree

NDX-10BTMOU-A1750F



Material Specifications

Enclosure Material Type

Gasketed hardened plastic

Optical Specifications

Fiber Type

G.652.D

Operating Wavelength Range

1260 – 1635 nm

Attenuation Cable Coefficient, maximum

0.30 dB/km @ 1550 nm | 0.40 dB/km @ 1310 nm

Attenuation Splitter, maximum

10.4 dB

Attenuation Terminal Connectors, maximum

0.45 dB

Directivity, minimum

60 dB

Uniformity, maximum

1 dB

Insertion Loss, Splitter, typical

10 dB

Insertion Loss, Stub Connector, maximum

0.45 dB

Insertion Loss, Stub Connector, typical

0.16 dB

Insertion Loss, Terminal Connector, typical

0.16 dB

Return Loss, Connector, minimum

65 dB

NDX-10BTMOU-A1750F

Return Loss, Single Ports, minimum 55 dB

Environmental Specifications

Operating Temperature -40 °C to +70 °C (-40 °F to +158 °F)
Relative Humidity 5%–100%, condensing
Environmental Space Above ground | Below ground | Buried
Flammability Rating UL 94 V-0
Qualification Standards IEC 60529, IP68 + 2 m waterhead | NEMA, Type 6 + 10 ft waterhead | Telcordia GR-3120-CORE | Telcordia GR-326-CORE | Telcordia GR-771-CORE
UV Resistance UV stabilized

Packaging and Weights

Included Enclosure (1) | Optical splitter (1) | Universal mounting bracket (1)
Packaging quantity 1
Packaging Type Box | Carton
Weight, without cable 1 kg | 2.205 lb

Regulatory Compliance/Certifications

Agency	Classification
CHINA-ROHS	Below maximum concentration value
ISO 9001:2015	Designed, manufactured and/or distributed under this quality management system
REACH-SVHC	Compliant as per SVHC revision on www.commscope.com/ProductCompliance
ROHS	Compliant
UK-ROHS	Compliant



Included Products

MST-UMB-MINI – DLX® Mini-MST, Fiber Optic Universal Mounting Bracket