



RealFlex® Fiber Optic Drop Cable, 4 Fiber, Hardened SC/APC to SC/APC with 10 ft Breakout at hardened SC/APC side, 50 ft

- Hardened connectors are factory-terminated and environmentally sealed for use in optical drop cable deployments
- Hardened drop cables incorporate hardened connector technology that is designed to withstand the rugged outside plant environment
- Hardened drop cables simplify installation and maintenance by reducing splicing requirements in the distribution portion of the network

Product Classification

Regional Availability	Asia Australia/New Zealand EMEA Latin America North America
Portfolio	CommScope®
Product Type	Fiber drop cable assembly
Product Series	FHBD

General Specifications

Color, boot A	Black
Color, boot B	Black
Color, connector A	Green
Color, connector B	Green
Connector A, quantity	4
Connector B, quantity	4
Interface, Connector A	Hardened full-size SC/APC
Interface Feature, connector A	Male
Interface, Connector B	SC/APC
Jacket Color	Black
Total Fibers, quantity	4
Transmission Standards	IEC 61753-1 IEC 61754-4 IEC 61755

Dimensions

Height Over Jacket	5 mm 0.197 in
Width Over Jacket	8 mm 0.315 in
Breakout Length, connector A	3048 mm 120 in

760239497 | FHBD-H10J084A-0050F

Breakout Length, connector B 2,438.4 mm | 96 in

Cord Length 15.24 m | 50 ft

Outline Drawing

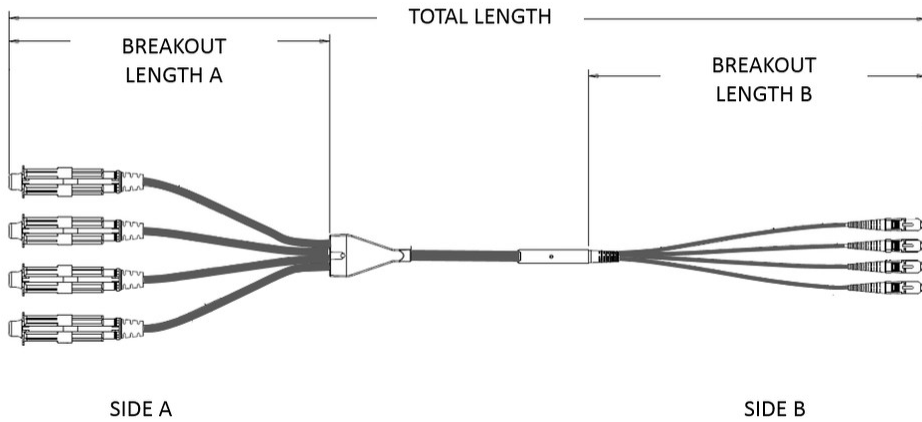

Ordering Tree

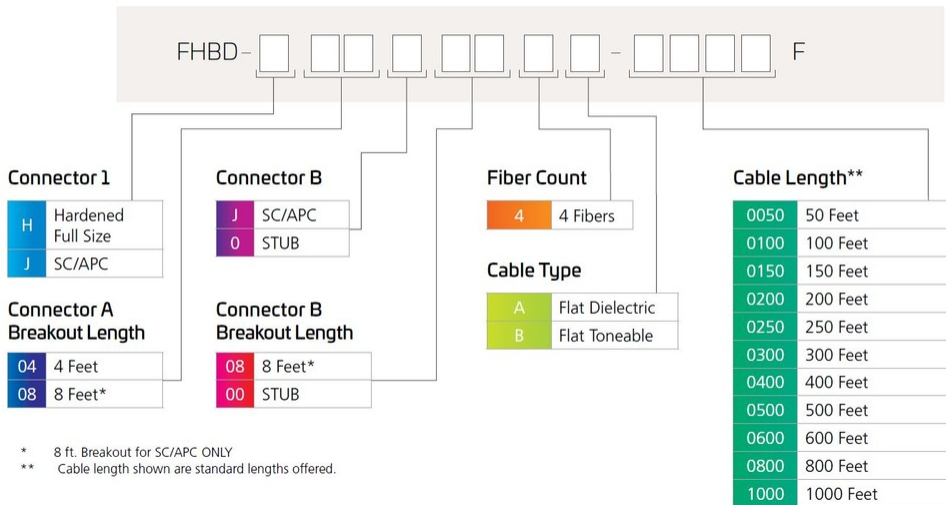

Representative Image

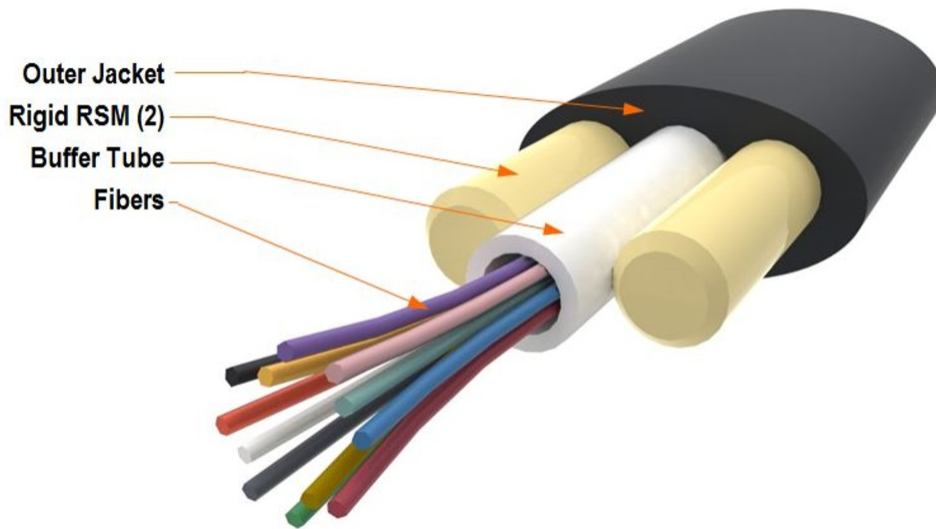

Material Specifications

Jacket Material Dielectric - Flat

Mechanical Specifications

Minimum Bend Radius, loaded 150 mm | 5.906 in

Minimum Bend Radius, unloaded 100 mm | 3.937 in

Tensile Load, long term, maximum 450 N | 101.164 lbf

Tensile Load, short term, maximum 1300 N | 292.252 lbf

Optical Specifications

Fiber Mode Singlemode

Fiber Type G.652.D

Insertion Loss, maximum, connector A 0.4 dB

Insertion Loss, maximum, connector B 0.4 dB

Return Loss, minimum, connector A 65 dB

Return Loss, minimum, connector B 65 dB

Environmental Specifications

Operating Temperature -40 °C to +70 °C (-40 °F to +158 °F)

Storage Temperature -40 °C to +70 °C (-40 °F to +158 °F)

760239497 | FHBD-H10J084A-0050F

Environmental Space	Outdoor
Jacket UV Resistance	UV stabilized
Qualification Standards	NEMA type 6, 10 ft waterhead Telcordia GR-20 Telcordia GR-3120 Telcordia GR-326

Packaging and Weights

Cable weight	38.7 kg/km 26.005 lb/kft
Packaging quantity	1

Regulatory Compliance/Certifications

Agency	Classification
CHINA-ROHS	Below maximum concentration value
REACH-SVHC	Compliant as per SVHC revision on www.commscope.com/ProductCompliance
ROHS	Compliant

