

EH0192-020 | C/A 2X24P RJ 100PIN 20M



48-pair Cable Assembly, 100-pin male connector to stub, for Nokia 7330 DSLAM, gray, 20 meters

- Designed to meet the requirements of VDSL transmission for use in FTTB/ FTTN deployments
- Small cable diameter allows usage in environments where space constraints and cable routing prove most challenging
- Single-ended cable assembly versions feature a copper wire diameter that is ideal to be terminated with LSA-PLUS modules

Product Classification

Regional Availability	Australia/New Zealand
Product Type	Copper trunk cable assembly

General Specifications

Conductor Type	Solid
Construction Type	Stranded
Interface, Connector A	100-pin male plug
Interface Feature, connector A	Backshell, 90°
Interface, Connector B	Unterminated
Jacket Color	Gray
Pairs, quantity	48
Total Ports, quantity	8

Dimensions

Cord Length	20 m 65.617 ft
Diameter Over Jacket	9.2 mm 0.362 in
Compatible Conductor Gauge, solid	26 AWG

Wiring Diagram

EH0192-020 | C/A 2X24P RJ 100PIN 20M

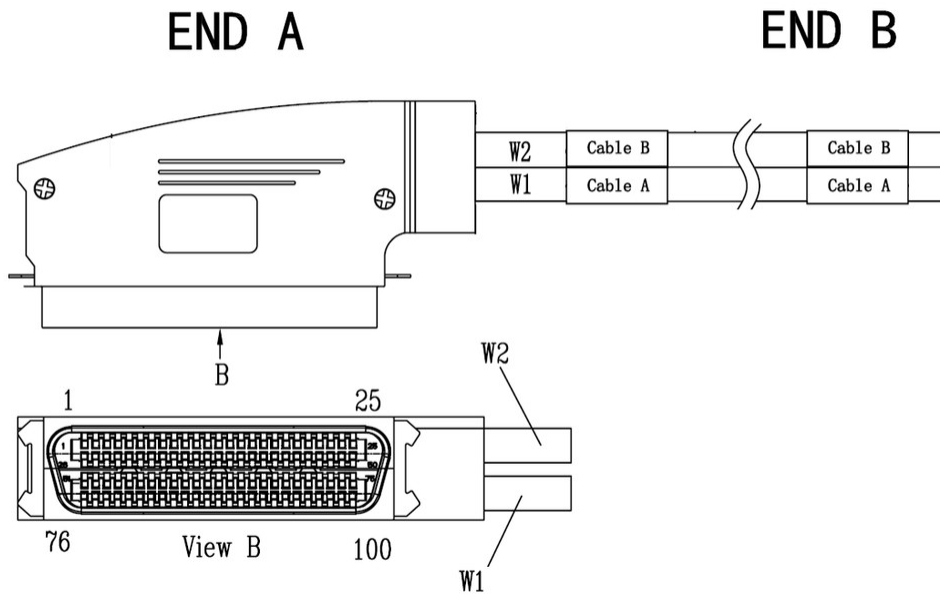

Electrical Specifications

Safety Voltage Rating 300 V

Material Specifications

Conductor Material Bare copper

Environmental Specifications

Operating Temperature -20 °C to +70 °C (-4 °F to +158 °F)

Storage Temperature -0 °C to +50 °C (32 °F to +122 °F)

Environmental Space Low Smoke Zero Halogen (LSZH)

Flammability Rating IEC 60332-1-2

Packaging and Weights

Packaging quantity 1