

## FIELD INSTALLED FANOUT KIT FOR 432-, 576- and 864-FIBER ROLLABLE RIBBON CABLE

### Contents

1.	Introduction	1
2.	Tools and Material Required	1
3.	Important General Notes	1
4.	Kit Components	2
4.1	432-Fiber Cable Kit	2
4.2	576-Fiber Cable Kit	2
4.3	864-Fiber Cable Kit	3
4.4	Armored Cable Kits (Separately Ordered)	4
5.	Procedure	5
5.1	Preparing Armored Cable	5
5.2	Preparing the Cable	7
5.3	Installing the Fanout	9
5.4	Applying Shrink Tubing to Fanout	15
6.	Trademarks	16
7.	Contact Information	16

### 1. Introduction

This document describes how to install a CommScope Field Fanout Kit for a 432-, 576-, or 864-fiber rollable ribbon cable. Contents include tables listing kit components, a list of required tools and material, general guidelines, and a four-part procedure.

**Note:** Armor kits are sold separately.

### 2. Tools and Material Required

Obtain these tools and material and have them on hand before beginning the procedure:

- Cable armor cutting tool (for armor cables)
- Tape measure
- Cable sheath ring cutting tool, sheath knife, or utility knife
- Needle nose pliers
- Scissors or electrician's snips
- Rags or paper towels
- Heat gun

### 3. Important General Notes

1. *If the cable assembly requires additional handling to route into place at the rack or cabinet, it is strongly recommended to handle the cable assembly ONLY by the cable sheath or armor. Avoid applying pull tension or excessive twisting motion to the fanout assembly and/or furcation tubes!*
2. *Refer to the instruction sheet included in the armor kit for the proper installation steps for securing the cable armor fitting to a rack or cabinet and grounding the cable armor.*

## 4. Kit Components

### 4.1 432-Fiber Cable Kit

Table 1 lists the components.

**Table 1: 432-Fiber Rollable Cable Fanout Kit Components**

Item	Qty	UOM	Description
1	135	FT	Furcation Tubing
2	1	EA	Installation Instructions
3	1	EA	Furcation Tube Labels 1-36
4	1	EA	Base
5	1	EA	Cover
6	1	EA	Cable Adapter Insert
7	1	EA	Instant Adhesive
8	12	EA	Alcohol Wipe
9	1	EA	Heat Shrink Tubing, Adhesive lined, 3" (7.6 cm) length, 1.25" (3.2 cm) diameter
10	1	EA	Spiral Wrap
11	1	EA	Cold Shrink Tubing

### 4.2 576-Fiber Cable Kit

Table 2 lists the components.

**Table 2: 576-Fiber Rollable Cable Fanout Kit Components**

Item	Qty	UOM	Description
1	180	FT	Furcation Tubing
2	1	EA	Installation Instructions
3	1	EA	Furcation Tube Labels 1-48
4	1	EA	Base
5	1	EA	Cover
6	1	EA	Fiber Retainer Insert
7	2	EA	Instant Adhesive
8	16	EA	Alcohol Wipe
9	1	EA	Heat Shrink Tubing, Adhesive lined, 3" (7.6 cm) length, 1.25" (3.2 cm) diameter
10	1	EA	Spiral Wrap
11	1	EA	Cold Shrink Tubing

### 4.3 864-Fiber Cable Kit

Table 3 lists the components.

**Table 3: 864-Fiber Rollable Cable Fanout Kit Components**

Item	Qty	UOM	Description
1	270	FT	Furcation Tubing
2	1	EA	Installation Instructions
3	1	EA	Furcation Tube Labels 1-72
4	1	EA	Base
5	1	EA	Cover
6	1	EA	Fiber Retainer Insert
7	2	EA	Instant Adhesive
8	24	EA	Alcohol Wipe
9	1	EA	Heat Shrink Tubing, Adhesive lined, 3" (7.6 cm) length, 1.25" (3.2 cm) diameter
10	1	EA	Spiral Wrap
11	1	EA	Cold Shrink Tubing

#### 4.4 Armored Cable Kits (Separately Ordered)

Table 4 and Table 5 list the components.



**Table 4: 432-Fiber Cable Armor Kit Components**

Item	Qty	UOM	Description
1	1	EA	Installation Instructions (not shown)
2	1	EA	Mounting Bracket Kit
3	1	EA	Heat Shrink Tubing, Adhesive lined, 4" (10.2 cm), length, 1.5" (3.8 cm) diameter
4	1	EA	Ground Cable, #6, Lugged 10" (25.4 cm)
5	1	EA	Armor Fitting

**Table 5: 576/864-Fiber Cable Armor Kit Components**

Item	Qty	UOM	Description
1	1	EA	Installation Instructions (not shown)
2	1	EA	Mounting Bracket Kit
3	1	EA	Heat Shrink Tubing, Adhesive lined, 4" (10.2 cm), length, 2.0" (5.1 cm) diameter
4	1	EA	Ground Cable, #6, Lugged 10" (25.4 cm)
5	1	EA	Armor Fitting

## 5. Procedure

Proceed as follows to install a field fanout kit.

### 5.1 Preparing Armored Cable

If the fanout kit is being installed on an armored cable, complete the following section; otherwise proceed directly to [Section 5.2](#).

**Note:** [Section 5.1](#) is done for armored cable only.

1. Determine the desired length between the end of the cable armor and the fanout assembly. On the factory-terminated end of the cable assembly, this length will be approximately 36 inches (91.4 cm), but it could be longer on the field terminated end if desired depending on where the armor will be attached to the rack or cabinet and where the fanout will be located. Add 45 inches (114.3 cm) to this measurement to allow for the length of the ribbon furcation tubes.
2. Measure, mark, and cut the cable armor at this location. Use caution while cutting the armor to prevent accidentally cutting into the cable sheath.



3. Slide the cable armor off of the cable.



4. Slide the heat shrink tubing included in the armor kit over the end of the cable.



5. Slide the heat shrink tubing up past the cable armor and out of the way.
6. Slide on the armor fitting.





7. Trim back the armor jacket about 1 inch (2.5 cm) to prepare a place for the armor fitting to be threaded onto the interlocking steel armor.



8. Thread the armor fitting onto the interlock steel armor and tighten until snug.



9. Slide the heat shrink tubing over the rear of the armor fitting until it reaches the flange at the end of the armor.



10. Using the most effective distance and lowest effective heat setting on the heat gun, shrink the heat shrink tube until it is fully compressed.

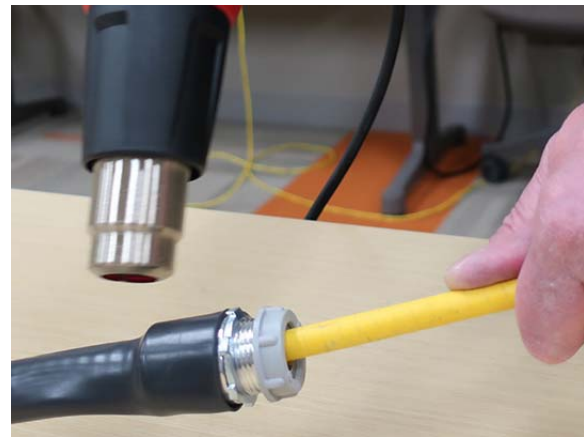

**Note:** The heat shrink is adhesive lined so it is normal to see a small amount of adhesive leaking out at the edges of the tubing.

**Caution!** *Do not allow adhesive to come in contact with skin or clothing until fully cooled.*

11. Below is an example of a completed armor kit.



## 5.2 Preparing the Cable

To prepare the cable, proceed as follows.

1. Slide the cold shrink tubing over the cable stub end.



2. Slide the cold shrink tubing up the cable and out of the way.



3. Slide the 3-inch (7.6 cm) cable-to-base heat shrink tubing over cable stub end.



4. Slide the 3-inch (7.6 cm) heat shrink tubing up the cable and out of the way.



5. Measure and mark the cable sheath at 45 inches (114.3 cm) from the stub end of the cable.

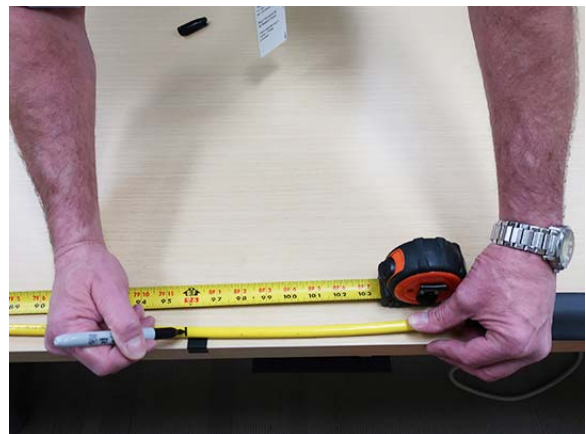

6. Make a ring cut around the cable sheath at the 45 inches (114.3 cm) mark.





7. Make a ring cut approximately 3 inches (7.6 cm) from the end of the cable.



8. Remove the sheath exposing the ripcord(s) at the stub end of the cable.



9. Pull the ripcord(s) to split the cable sheath back to the ring cut at the 45 inches (114.3 cm) mark. Needle nose pliers can be helpful to grasp and pull the ripcord(s).



10. Manually separate the central tube (blue in the photo below) from the cable sheath, strength members, tape liner(s), and ripcord(s).



11. Remove the cable sheath, strength members, tape liner(s), and ripcord(s) at the ring cut, leaving just the central tube.

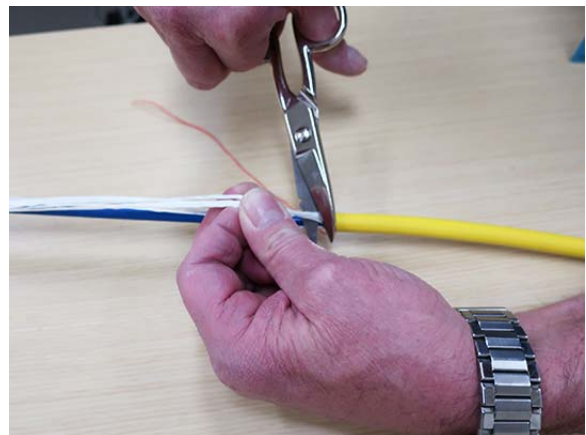
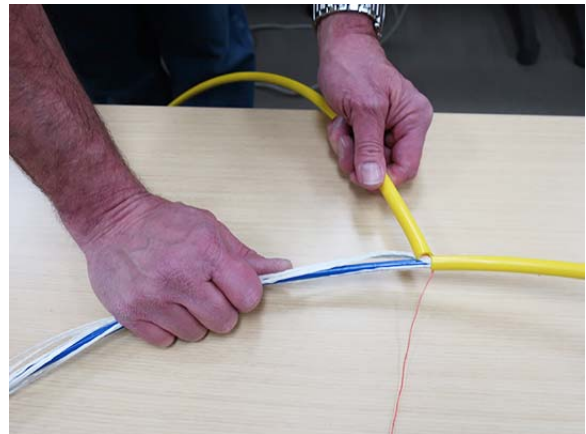



12. Carefully score the central tube near the point where it exits the cable sheath. Use an appropriately sized ring cutter (shown) if available. A utility knife may be used as an alternate. **USE EXTREME CAUTION NOT TO DAMAGE ANY FIBERS.**



13. Snap off the central tube at the score line.

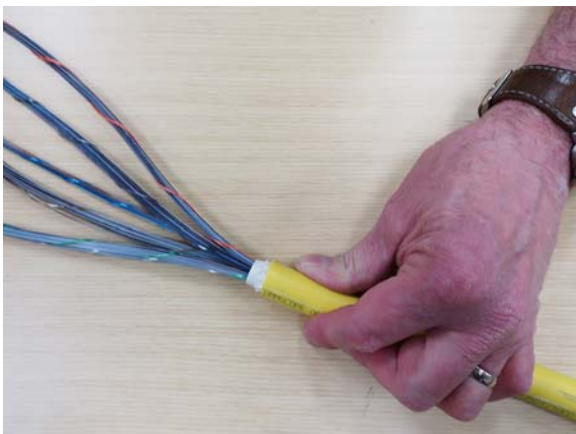
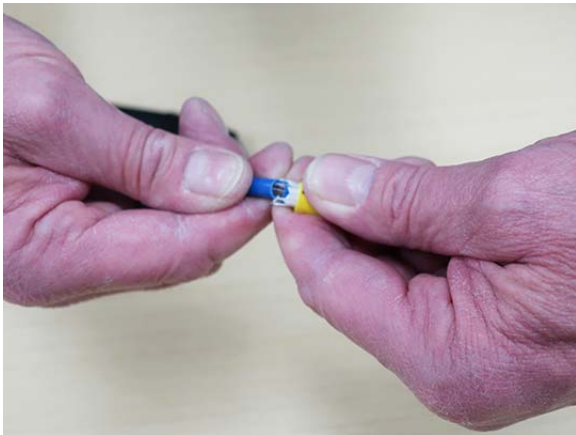

14. As shown, the ribbons are grouped into binder groups of twelve ribbons each (144 fibers) and the binder groups are identified by a colored yarn wrap:

- **Blue** for binder group 1 (ribbons 1-12),
- **Orange** for binder group 2 (ribbons 13-24),
- **Green** for binder group 3 (ribbons 25-36), etc.

The binder group color sequence follows the standard fiber color code sequence.

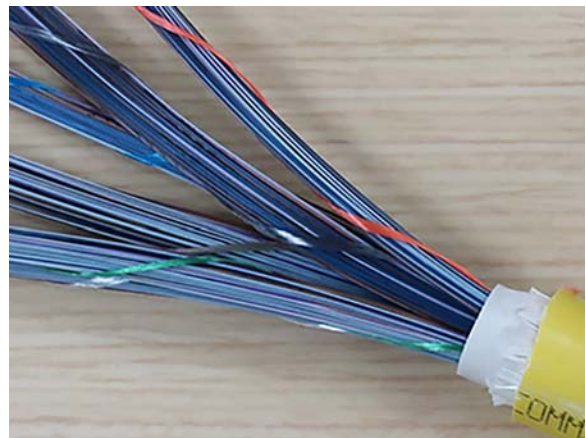

### 5.3 Installing the Fanout

To install the fanout, proceed as follows.

1. **(FOR 432-FIBER FANOUT KIT ONLY)** Identify the cable adapter insert for the base.



2. Install the cable adapter insert into the rear tube of the base. There is only one orientation of the insert that will allow it to be installed fully and properly.

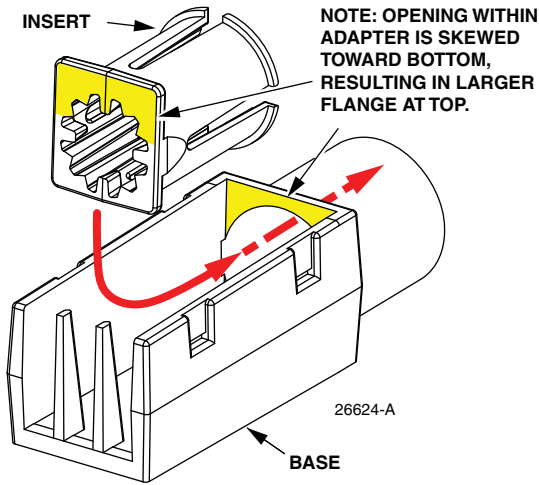

**Note:** In the following photos, unless otherwise noted, the fanout shown is for a 576-fiber cable. It has a three-channel fiber retainer insert, as does the fanout for an 864-fiber cable. The fiber retainer in the fanout for a 432-fiber cable is integral to the fanout.

3. Feed the ribbons through the rear of the base and slide the base up and over the cable sheath.

**Note:** The base should fit very snugly around the cable sheath. If necessary, make one or two wraps of electrical tape around the cable sheath to ensure a snug fit.



4. **(FOR 576- AND 864- FIBER FANOUT KIT ONLY)** Insert the 3-channel fiber retainer insert into the fanout base.



5. Cut the 3mm furcation tubing into 36 pieces (for 432-fiber cable), or 48 pieces (for 576-fiber cable), or 72 pieces (for 864-fiber cable), at 41 inches (104.1 cm).

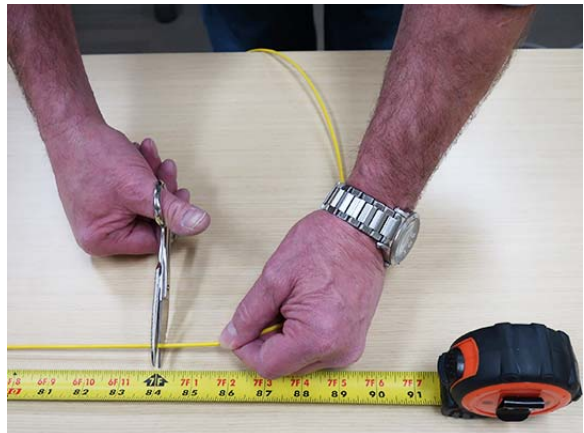

- Apply one numerical ID label to each furcation tube 12 inches (30.5 cm) from the end of the furcation tube.

**Note:** Individual ribbons are identified with printed ID numbers and block/line markings. If the ID number to the left is unclear, obtain the value by adding block/line markings on the right. Each rectangular block has a value of 5 and each line has a value of 1.

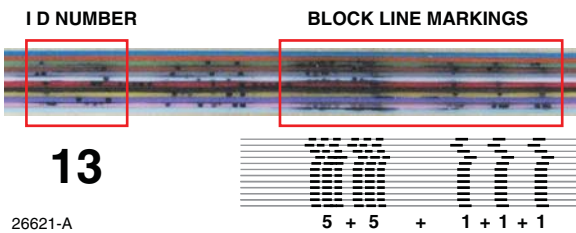

- At the end opposite of the label, cut the ends of the tubes at a 45-degree angle. This allows easier insertion of the ribbons into the tubes.



- Assign the binder groups to a vertical channel as follows for each fanout kit size:

**Note:** Observe how the binder groups exit the cable sheath, and allow each binder group to occupy the vertical channel that best corresponds to the orientation of the binder group as it exits the cable sheath. It is NOT important to place them in the channels in sequential order. Try to prevent the binder groups from crossing over one another in the fanout base.

- 432-fiber Fanout Kit:** The 432-fiber cable has three binder groups (blue, orange, and green) and the fanout base has three vertical channels. Each binder group will occupy one of the channels.





- 576-fiber Fanout Kit:** The 576-fiber cable has four binder groups (blue, orange, green, and brown) and the fanout base has three vertical channels. Binder groups 1 and 2 (blue and orange) will occupy one of the vertical channels and binder groups 3 and 4 (green and brown) will occupy an adjacent vertical channel. One vertical channel will remain unused, but it should never be the center channel.

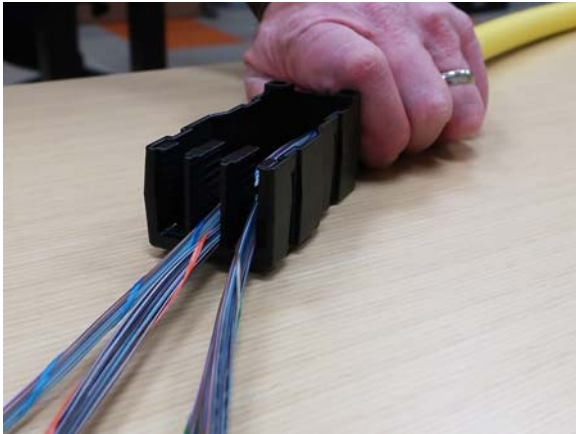

- 864-fiber Fanout Kit:** The 864-fiber cable has six binder groups (blue, orange, green, brown, slate, and white) and the fanout base has three vertical channels. Binder groups 1 and 2 (blue and orange) will occupy one vertical channel, binder groups 3 and 4 (green and brown) will occupy another vertical channel, and binder groups 5 and 6 (slate and white) will occupy the third channel.

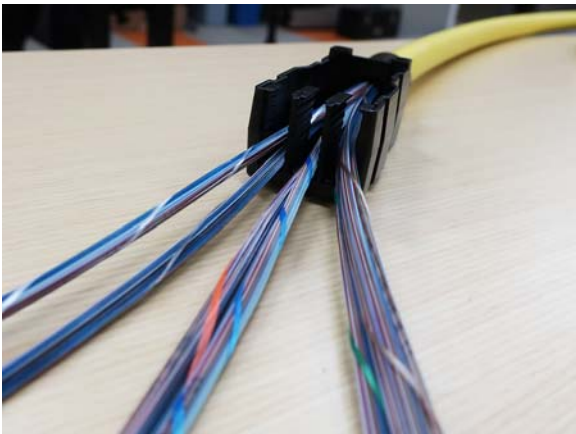

- Working in one vertical channel at a time, locate the binder group that is oriented in the bottom of the vertical channel (for the 432-fiber fanout, there will only be one binder group in each vertical channel). If present, lift the other binder group of ribbons out of the vertical channel and place them aside. Using scissors, carefully trim the colored binder yarn on the binder group remaining in the vertical channel  $\frac{1}{2}$ " (13 mm) from the cable side of the fanout base. Use caution to prevent cutting the ribbons!

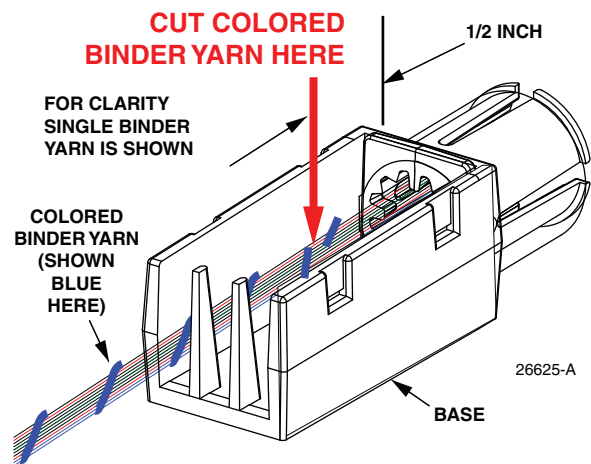

- At the far end of the binder group, grasp the colored binder yarn and slide the yarn off the end of the binder group.

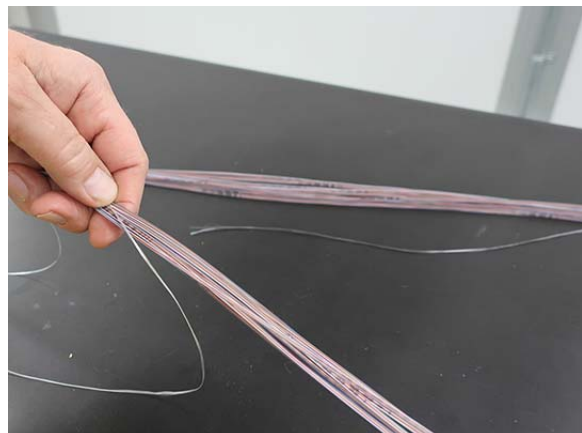



11. Select one of the ribbons in the binder group and identify its ID number as printed on the ribbon. Feed the ribbon into the 45-degree cut in the associated numbered furcation tube. The ribbons may be cleaned with an alcohol wipe prior to insertion into the tubes if desired to aid in the insertion process, although this step may be unnecessary.

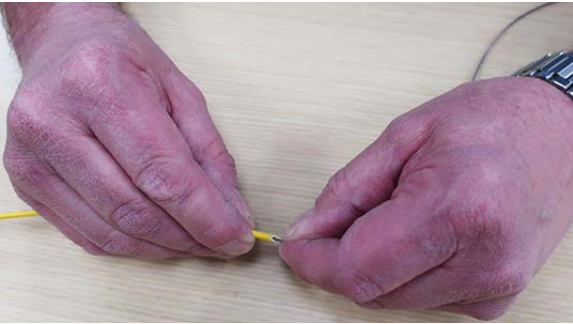

**Caution!** If the ribbons are cleaned with alcohol, be aware that this may smear or remove the identification marks on the ribbons.

**Note:** Laying out the furcation tube as flat and straight as possible will aid in feeding the ribbon into the tube.



12. Once the ribbon appears at the opposite end of the tube, the ribbon can be held steady and the furcation tubing can be pushed toward the base.

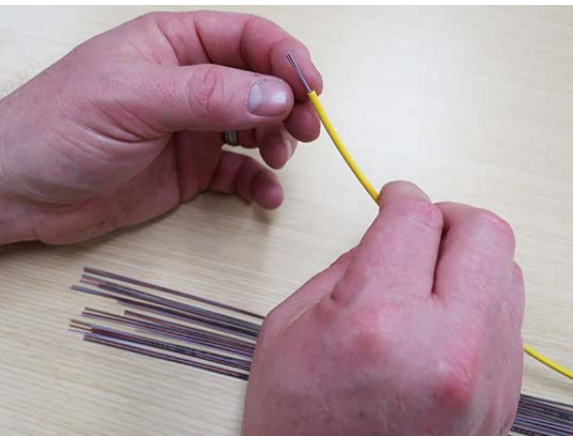

13. Slide the furcation tube all the way into the fanout base until it meets the end of the cable.
14. Repeat Steps 11-13 for the remaining ribbons in the binder group.
15. At this point, one binder group of ribbons in the vertical channel should be fully populated with furcation tubes. Lift the furcation tubes out of the base and observe the natural order of the furcation tubes as the ribbons exit the cable sheath.



**Note:** It is important to try to maintain this order as the tubes are loaded back into the vertical channel in the base to ensure that the ribbons do not become twisted or cross over one another.

16. Locate the furcation tubes that are best oriented to make up the bottom row in the vertical channel. This will be either 2 or 3 tubes depending on cable size. Place the tubes in a neat horizontal order across the floor of the channel and slowly pull each furcation tube in the row away from the cable sheath to expose approximately 1 inch (2.5 cm) of bare ribbon within the fanout base.

17. At a point about 1/8 inch-1/4 inch (3 mm - 6 mm) outside the fanout base, apply the adhesive generously to the first horizontal row of furcation tubes. Ensure that the application of the adhesive occurs between all the tubes. Do not allow adhesive to dry before starting Step 18.

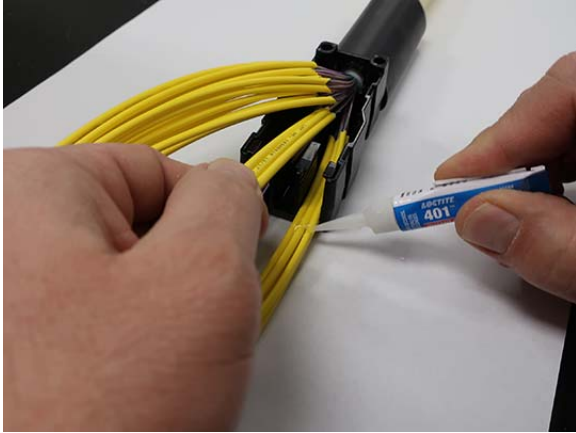

**Note:** The goal of this step is to securely glue all the tubes together and it is a **CRITICAL STEP** in the installation process, so don't skimp on the application of the adhesive horizontally and vertically.

18. Place into the channel the next 2 or 3 tubes to form a second horizontal row.

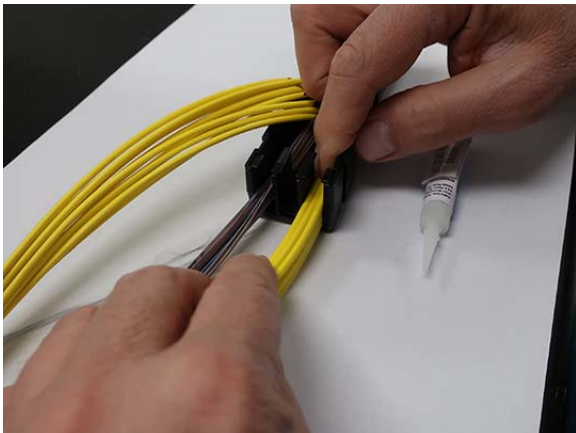

**Caution!** Do not allow instant adhesive to come into contact with skin or clothing until fully cured. Carefully read safety label warning adhered to adhesive tube.

19. Apply adhesive generously to the second horizontal row of furcation tubes. Ensure that the application of the adhesive occurs between all the tubes.

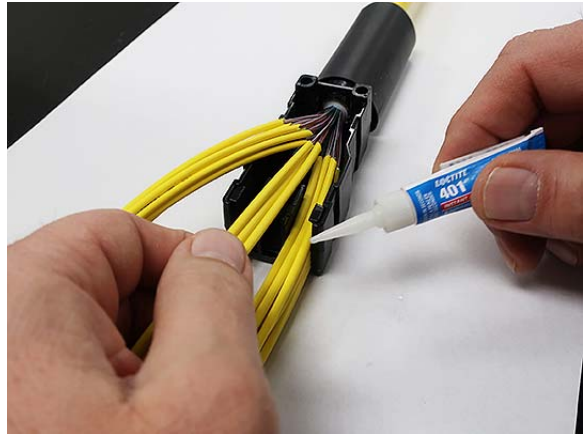

20. Continuing building horizontal rows and then applying adhesive until the first binder has been glued into place. Wipe up any excess adhesive from the work area. Allow adhesive a few minutes of drying time before continuing.

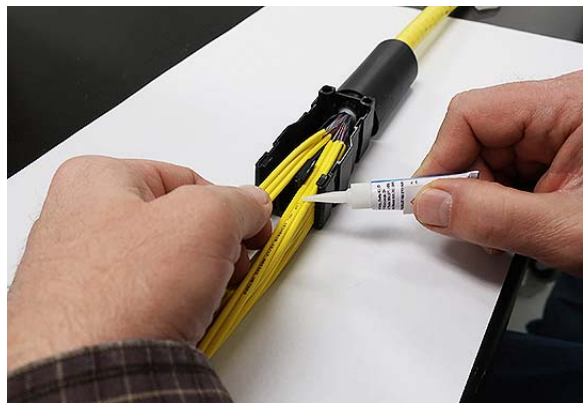

21. Repeat steps 9-20 for the remaining binder groups in each vertical channel beginning with the bottom binder group in each channel.

**Note:** Depending on the cable size, the furcation tubes will arrange into either 2 or 3 tubes per horizontal row, and successive rows will form a matrix as follows (horizontal x vertical x number of channels):  
 432-fiber cable: 2x6x3  
 576-fiber cable: 3x8x2  
 864-fiber cable: 3x8x3

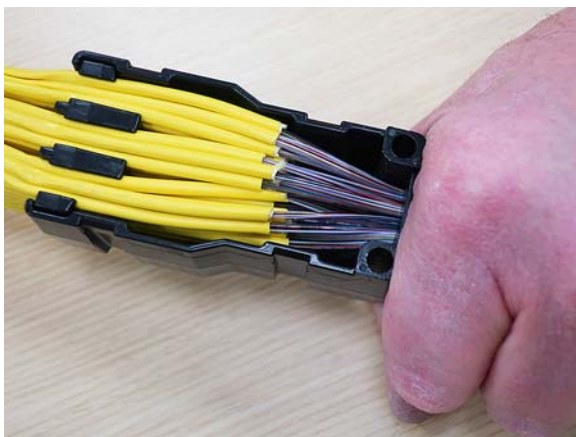

22. Install the cover on the base.

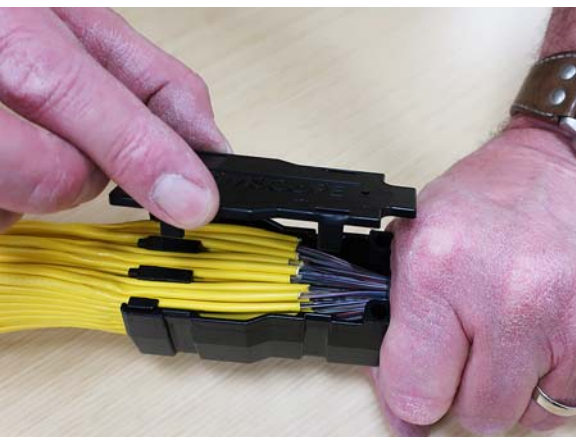

## 5.4 Applying Shrink Tubing to Fanout

To apply heat shrink tubing to the fanout, proceed as follows.

1. Slide the heatshrink over the fanout tube until it touches the fanout base (action labeled "1" in photo below).

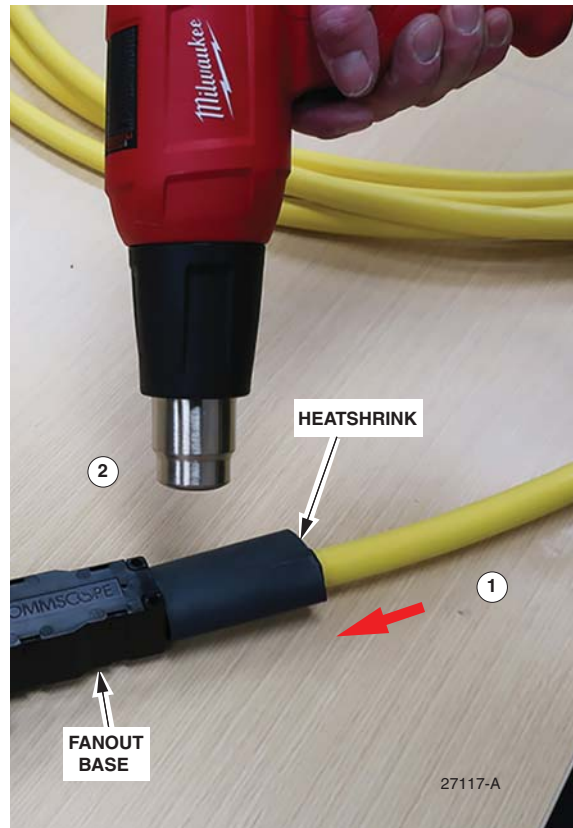

2. Using the most effective distance and lowest effective heat setting on the heat gun, begin heating the heat shrink tube (action labeled "2" in photo above). Apply uniform heat around and across the heat shrink, using special care to prevent extreme differences in diameter. Uneven heating will cause trapped air pockets and/or backwards curling at the ends. The heat shrink is adhesive lined so it is normal to see a small amount of adhesive leaking out at the edge of the tubing.

**Caution!** *Do not allow adhesive to come in contact with skin or clothing until fully cooled.*



3. Install spiral wrap around furcation tubes. Spiral wrap should begin at fanout.



4. Slide cold shrink tubing over fanout. Position approximately 0.50 inch (1.27 cm) from end of fanout, leaving mounting holes exposed. Pull plastic tail to remove core from tubing, allowing tubing to shrink over fanout and spiral wrap.

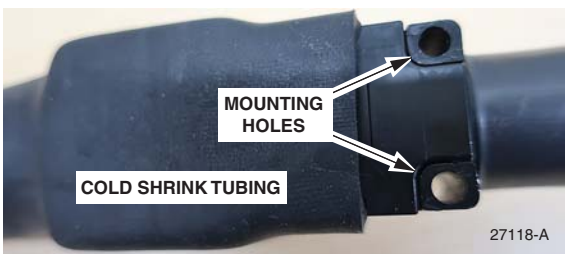
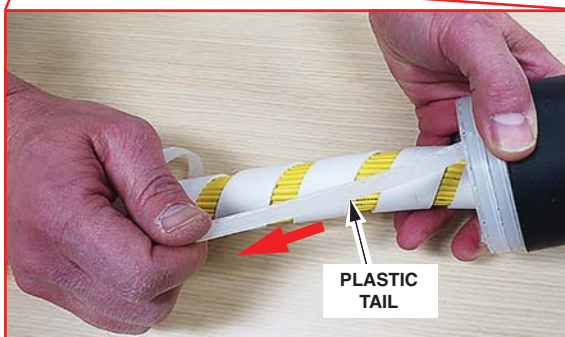
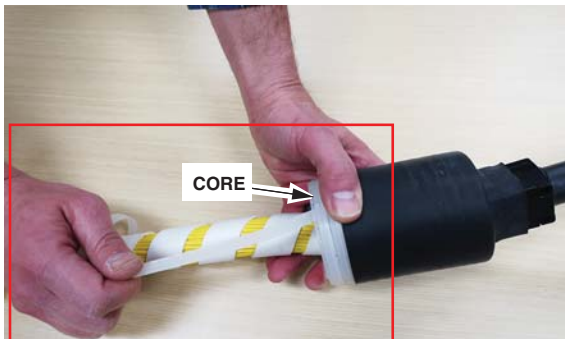

27118-A

5. The cable assembly is now ready for splicing or connectorization. See example below.



## 6. Trademarks

All trademarks identified by ® or ™ are registered trademarks or trademarks, respectively, of CommScope, Inc. This document is for planning purposes only and is not intended to modify or supplement any specifications or warranties relating to CommScope products or services.

CommScope is committed to the highest standards of business integrity and environmental sustainability, with a number of CommScope's facilities across the globe certified in accordance with international standards, including ISO 9001, TL 9000, and ISO 14001. Further information regarding CommScope's commitment can be found at: [www.commscope.com/About-Us/Corporate-Responsibility-and-Sustainability](http://www.commscope.com/About-Us/Corporate-Responsibility-and-Sustainability)

## 7. Contact Information

Visit our website or contact your local CommScope representative for more information.

- To find out more about CommScope® products, visit us on the web at [www.commscope.com](http://www.commscope.com)
- For technical assistance, customer service, or to report any missing/damaged parts, visit us at <http://www.commscope.com/SupportCenter>