

SHPX1-32/B

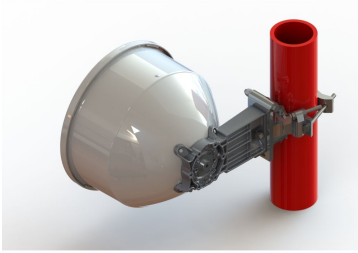

0.3 m | 1 ft Sentinel® High Performance Antenna, dual-polarized,
31.000–33.400 GHz

Product Classification

Product Type	Microwave antenna
Product Brand	Sentinel®

General Specifications

Antenna Type	SHPX - Sentinel® High Performance Antenna, dual-polarized
Polarization	Dual
Side Struts, Included	0
Side Struts, Optional	0

Dimensions

Diameter, nominal	0.3 m 1 ft
--------------------------	--------------

Electrical Specifications

Operating Frequency Band	31.000 – 33.400 GHz
Gain, Low Band	38.5 dBi
Gain, Mid Band	38.7 dBi
Gain, Top Band	38.9 dBi
Boresite Cross Polarization Discrimination (XPD)	30 dB
Front-to-Back Ratio	67 dB
Beamwidth, Horizontal	1.9 °
Beamwidth, Vertical	1.9 °
Return Loss	17.7 dB
VSWR	1.3
Radiation Pattern Envelope Reference (RPE)	7282B

SHPX1-32/B

Electrical Compliance

Brazil Anatel Class 2 | Canada SRSP 321.8 Part B | ETSI 302 217 Class 4 | US FCC Part 101A

Cross Polarization Discrimination (XPD) Electrical Compliance

ETSI EN 302217 XPD Category 2

Mechanical Specifications

Compatible Mounting Pipe Diameter

50 mm–115 mm | 2.0 in–4.5 in

Fine Azimuth Adjustment Range

±15°

Fine Elevation Adjustment Range

±15°

Wind Speed, operational

201 km/h | 124.896 mph

Wind Speed, survival

250 km/h | 155.343 mph

SHPX1-32/B

Antenna Dimensions and Mounting Information

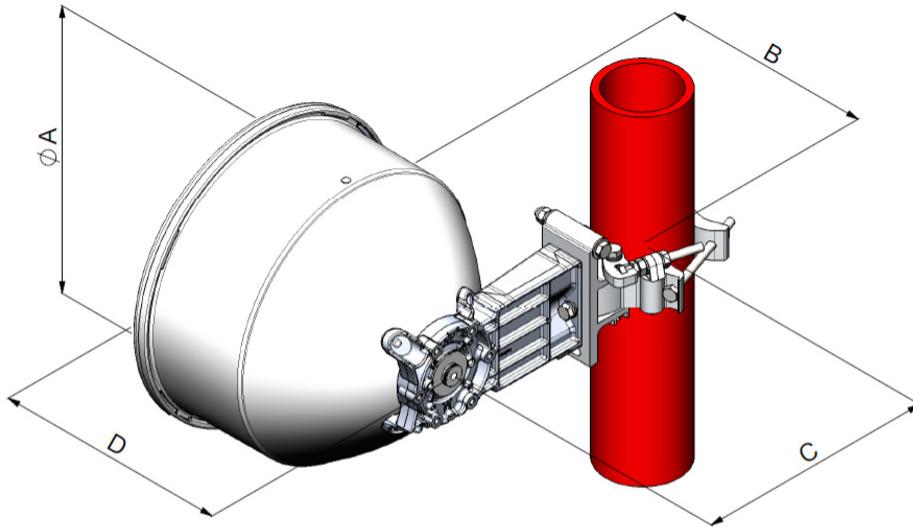

Dimension in Inches(mm)				
Antenna size, ft(m)	A	B	C	D
1(0.3)	15.3(389)	11.3(287)	12.8(326)	12.6(319)

Wind Forces at Wind Velocity Survival Rating

Axial Force (FA)	446 N 100.265 lbf
Angle α for MT Max	0°
Side Force (FS)	222 N 49.908 lbf
Twisting Moment (MT)	144 N-m 1,274.507 in lb
Zcg without Ice	74 mm 2.913 in
Zcg with 1/2 in (12 mm) Radial Ice	111 mm 4.37 in
Weight with 1/2 in (12 mm) Radial Ice	19 kg 41.888 lb

SHPX1-32/B

Wind Forces at Wind Velocity Survival Rating Image



Packaging and Weights

Weight, net

6 kg | 13.228 lb

Regulatory Compliance/Certifications

Agency

ISO 9001:2015

Classification

Designed, manufactured and/or distributed under this quality management system



* Footnotes

Operating Frequency Band

Bands correspond with CCIR recommendations or common

allocations used throughout the world. Other ranges can be accommodated on special order.

For a given frequency band, gain is primarily a function of antenna size. The gain of Andrew antennas is determined by either gain by comparison or by computer integration of the measured antenna patterns.

The difference between the peak of the co-polarized main beam and the maximum cross-polarized signal over an angle twice the 3 dB beamwidth of the co-polarized main beam.

Denotes highest radiation relative to the main beam, at $180^\circ \pm 40^\circ$, across the band. Production antennas do not exceed rated values by more than 2 dB unless stated otherwise.

The figure that indicates the proportion of radio waves incident upon the antenna that are rejected as a ratio of those that are accepted.

Maximum; is the guaranteed Peak Voltage-Standing-Wave-Ratio within the operating band.

Radiation patterns define an antenna's ability to discriminate against unwanted signals. Under still dry conditions, production antennas will not have any peak exceeding the current RPE by more than 3dB, maintaining an angular accuracy of $\pm 1^\circ$ throughout

The difference between the peak of the co-polarized main beam and the maximum cross-polarized signal over an angle twice the 3 dB beamwidth of the co-polarized main beam.

For VHLP(X), SHP(X), HX and USX antennas, the wind speed where the maximum antenna deflection is 0.3 x the 3 dB beam width of the antenna. For other antennas, it is defined as a deflection is equal to or less than 0.1 degrees.

The maximum wind speed the antenna, including mounts and radomes, where applicable, will withstand without permanent deformation. Realignment may be required. This wind speed is applicable to antenna with the specified amount of radial ice.

Maximum forces exerted on a supporting structure as a result of wind from the most critical direction for this parameter. The individual maximums specified may not occur simultaneously. All forces are referenced to the mounting pipe.

Maximum side force exerted on the mounting pipe as a

Gain, Mid Band

Boresite Cross Polarization Discrimination (XPD)

Front-to-Back Ratio

Return Loss

VSWR

Radiation Pattern Envelope Reference (RPE)

Cross Polarization Discrimination (XPD) Electrical Compliance

Wind Speed, operational

Wind Speed, survival

Axial Force (FA)

Side Force (FS)

result of wind from the most critical direction for this parameter. The individual maximums specified may not occur simultaneously. All forces are referenced to the mounting pipe.

Twisting Moment (MT)

Maximum forces exerted on a supporting structure as a result of wind from the most critical direction for this parameter. The individual maximums specified may not occur simultaneously. All forces are referenced to the mounting pipe.