

REV	MCO	DWN	DATE
A	40026918MCO	VFV	02-FEB-16
B	8000019186	SC	24-JAN-17

CATALOG NUMBER	FITTING TYPE REF	BRACKET ATTACHMENT DETAIL
FGS-MH9E-F-VS	12" 90° HORIZ ELBOW	DETAIL A (SHEET 2)
FGS-MHRT-F-VS	12" TEE	DETAIL B (SHEET 2)
FGS-MHRT-F/B-VS	12" TEE, 6" EXIT	DETAIL C (SHEET 2)
FGS-MHXP-F-VS	12" CROSS	DETAIL D (SHEET 3)
FGS-MHXP-B/F-VS	12" CROSS, 6" EXIT	DETAIL E (SHEET 3)
FGS-MDSP-F-VS	12" DOWNSPOUT	DETAIL F (SHEET 3)
FGS-MH4E-H-VS	24" 45° HORIZ ELBOW	DETAIL G (SHEET 4)
FGS-MHRT-H/F-VS	24" TEE, 12" EXIT	DETAIL H (SHEET 4)
FGS-MHXP-F/H-VS	24" CROSS, 12" EXIT	DETAIL J (SHEET 4)
FGS-MHXP-H-VS	24" CROSS	DETAIL K (SHEET 4)

CUSTOMER NOTES:

1. KIT INCLUDES VARIABLE SUPPORT BRACKETS AND 1/4 THREAD FORMING SCREWS.
2. FITTINGS SHOWN ARE FOR REFERENCE ONLY.
3. ASSEMBLE BRACKETS, WITH BENTS TABS FLUSH AGAINST FITTING RIBS, AS SHOWN IN FIGURES. TIGHTEN SCREWS COMPLETELY

COMMSCOPE, INC.

<small>© 2016 COMMSCOPE, INC. CONFIDENTIAL NOTICE: THESE DRAWINGS AND SPECIFICATIONS ARE THE PROPRIETARY PROPERTY OF COMMSCOPE, INC. AND MAY BE USED ONLY FOR THE SPECIFIC PURPOSE AUTHORIZED IN WRITING BY COMMSCOPE, INC.</small>		TITLE 12" FGS VARIABLE SUPPORT BRACKET KITS	
<small>ALL DIMS AND TOLERANCES .XX:±N/A ARE INCHES UNLESS .XXX:±N/A OTHERWISE SPECIFIED ANGULAR:±N/A</small>	C SIZE	DRAWING NUMBER 300100114140	B REV
DO NOT SCALE DRAWING	ENGR: RUBEN ARVILLA DWN: VICTOR FLORES	SHT. 1 OF 4	

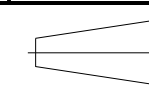
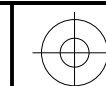

**DIMENSIONS IN INCHES
THIRD ANGLE PROJECTION**

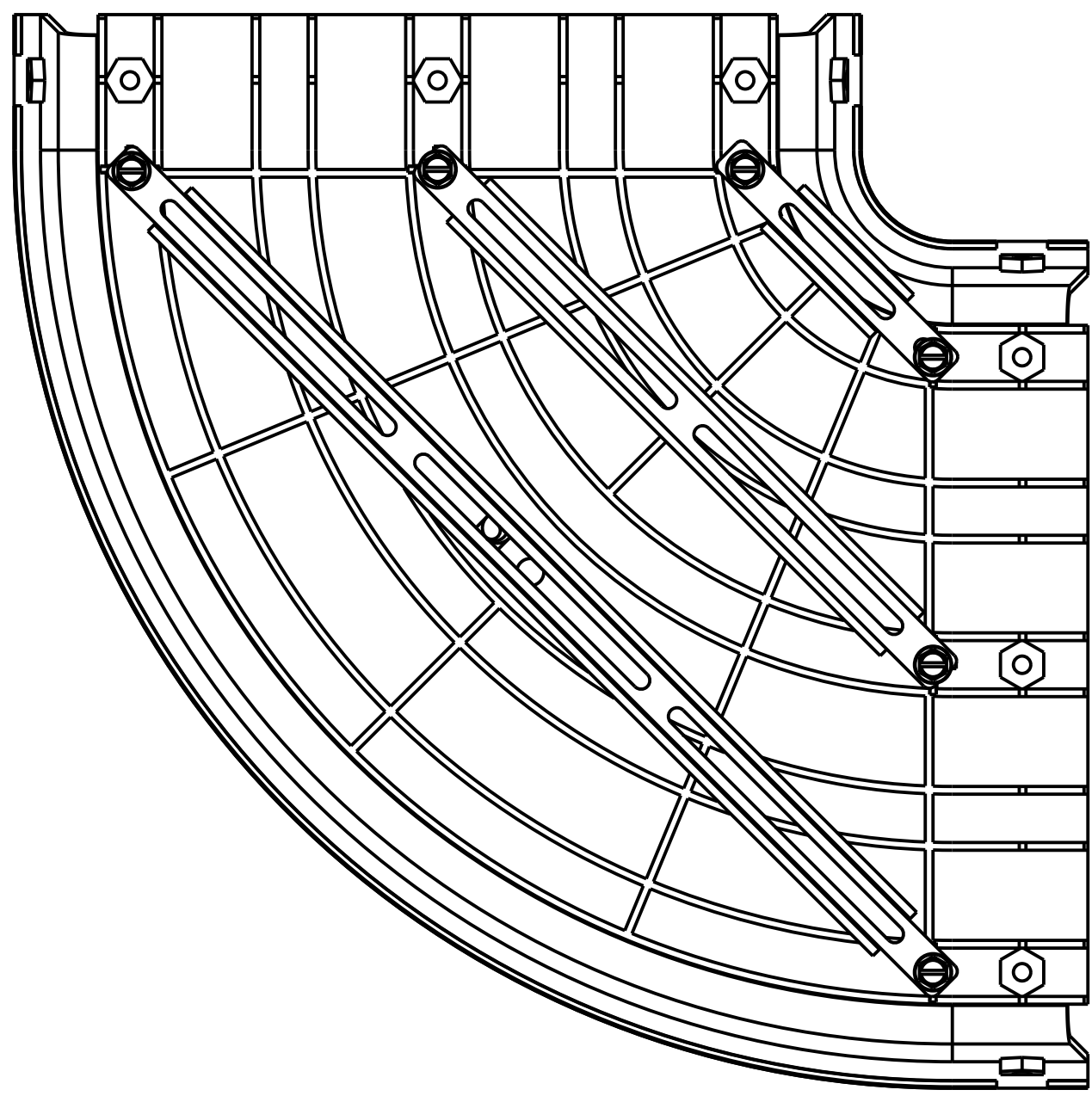

DETAIL A
12" 90° HORIZONTAL ELBOW
SCALE 0.375

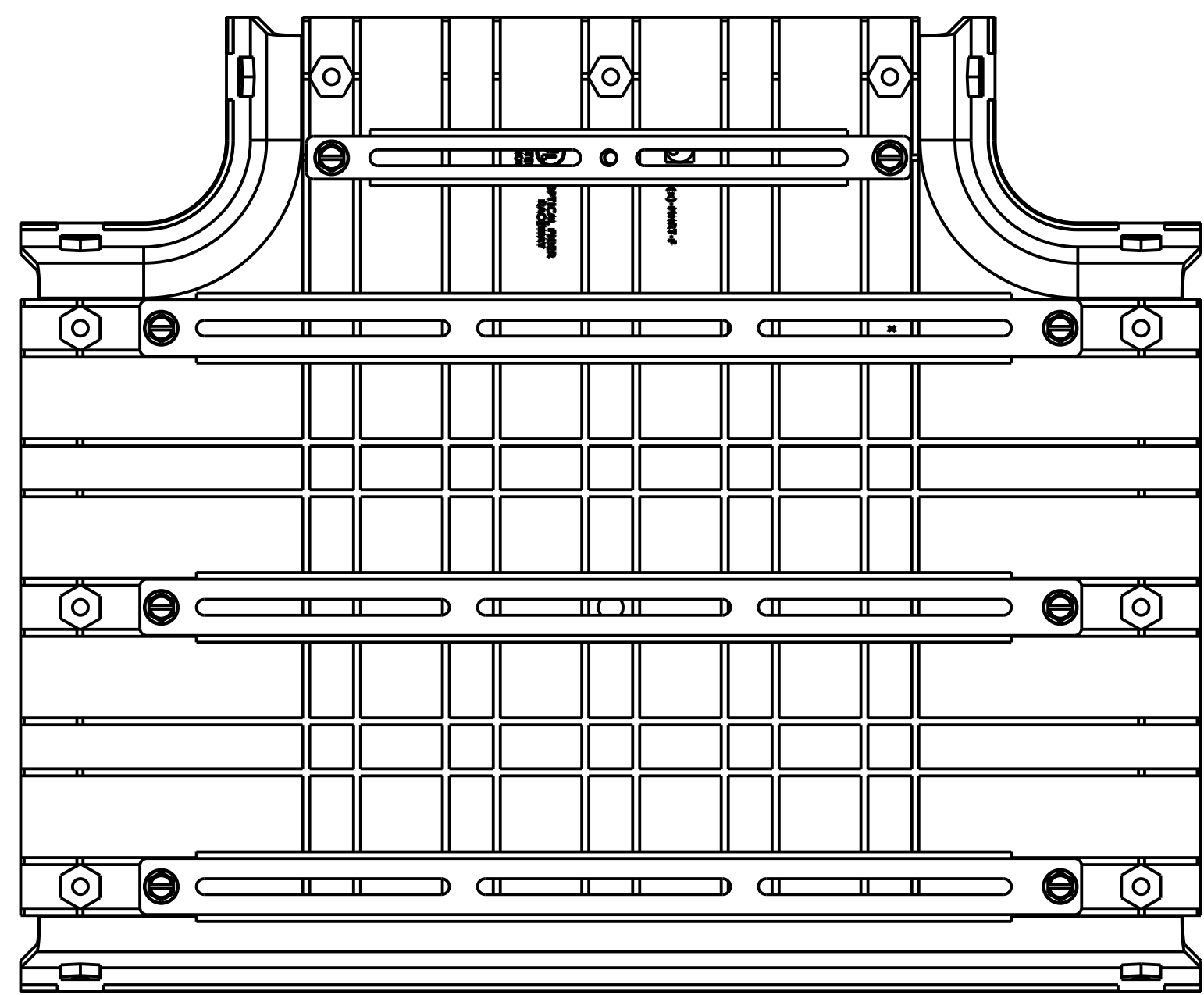

DETAIL B
12" TEE
SCALE 0.375

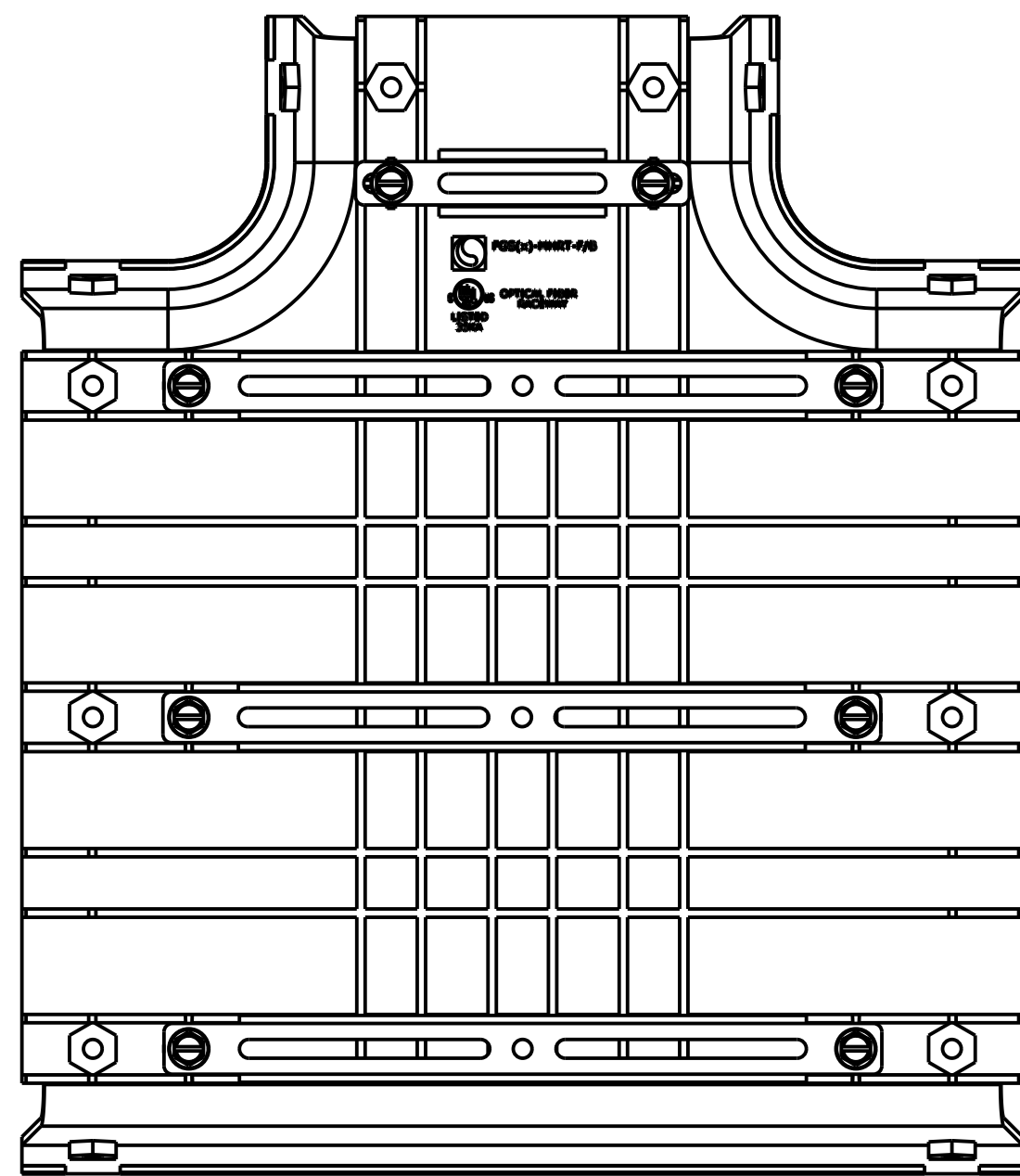

DETAIL C
12" TEE, 6" EXIT
SCALE 0.375

COMMSCOPE, INC.

<small>© 2016 COMMSCOPE, INC. CONFIDENTIAL NOTICE: THESE DRAWINGS AND SPECIFICATIONS ARE THE PROPRIETARY PROPERTY OF COMMSCOPE, INC. AND MAY BE USED ONLY FOR THE SPECIFIC PURPOSE AUTHORIZED IN WRITING BY COMMSCOPE, INC.</small>		TITLE 12" FGS VARIABLE SUPPORT BRACKET KITS	
<small>ALL DIMS AND TOLERANCES ARE INCHES UNLESS OTHERWISE SPECIFIED</small>	<small>.XX:±N/A .XXX:±N/A ANGULAR:±N/A</small>	C SIZE	DRAWING NUMBER 300100114140
DO NOT SCALE DRAWING		ENGR: RUBEN ARVILLA DWN: VICTOR FLORES	B REV SHT. 2 OF 4

DIMENSIONS IN INCHES
THIRD ANGLE PROJECTION

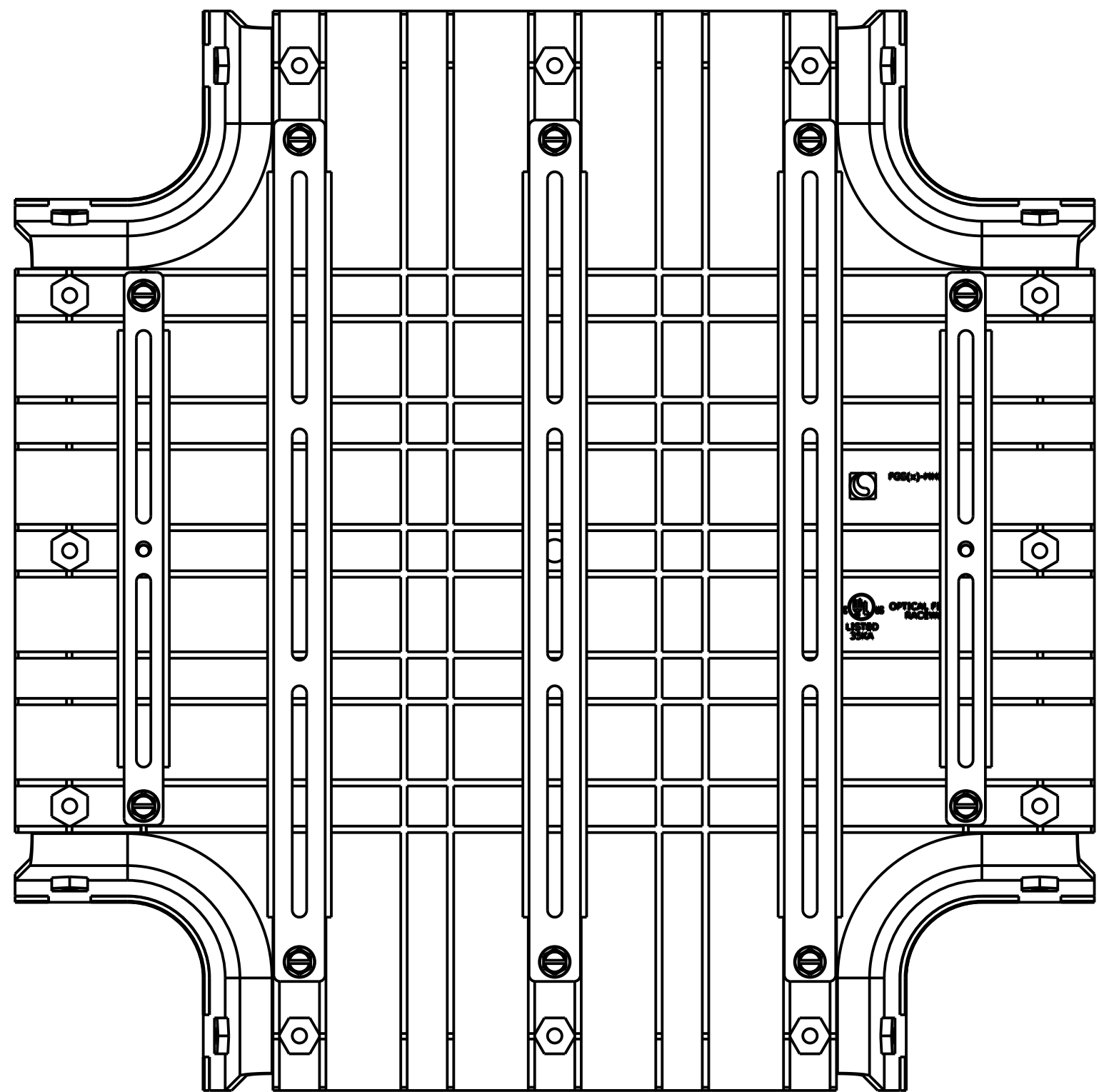

DETAIL D
12" CROSS
SCALE 0.375

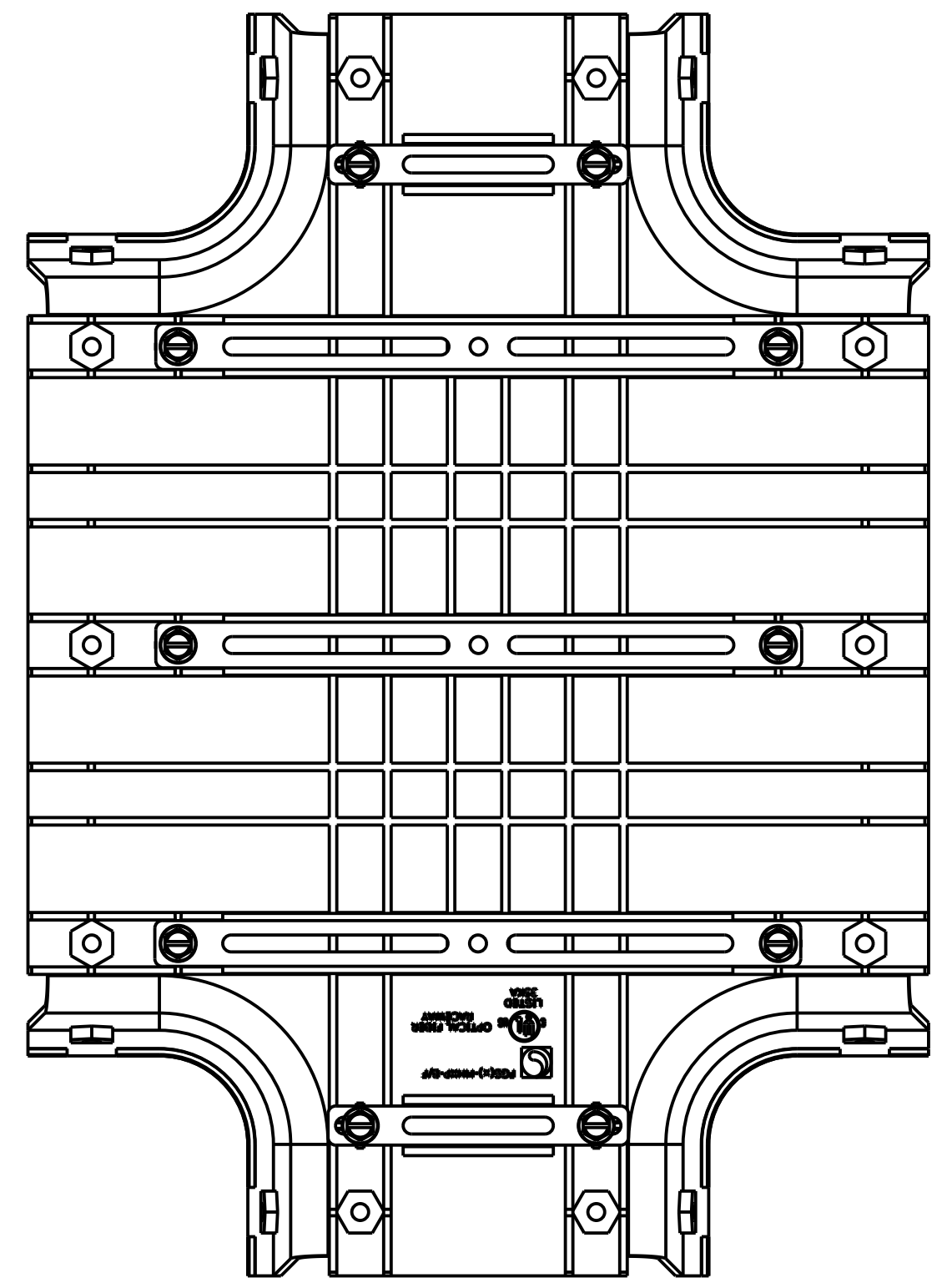

DETAIL E
12" CROSS, 6" EXIT
SCALE 0.375

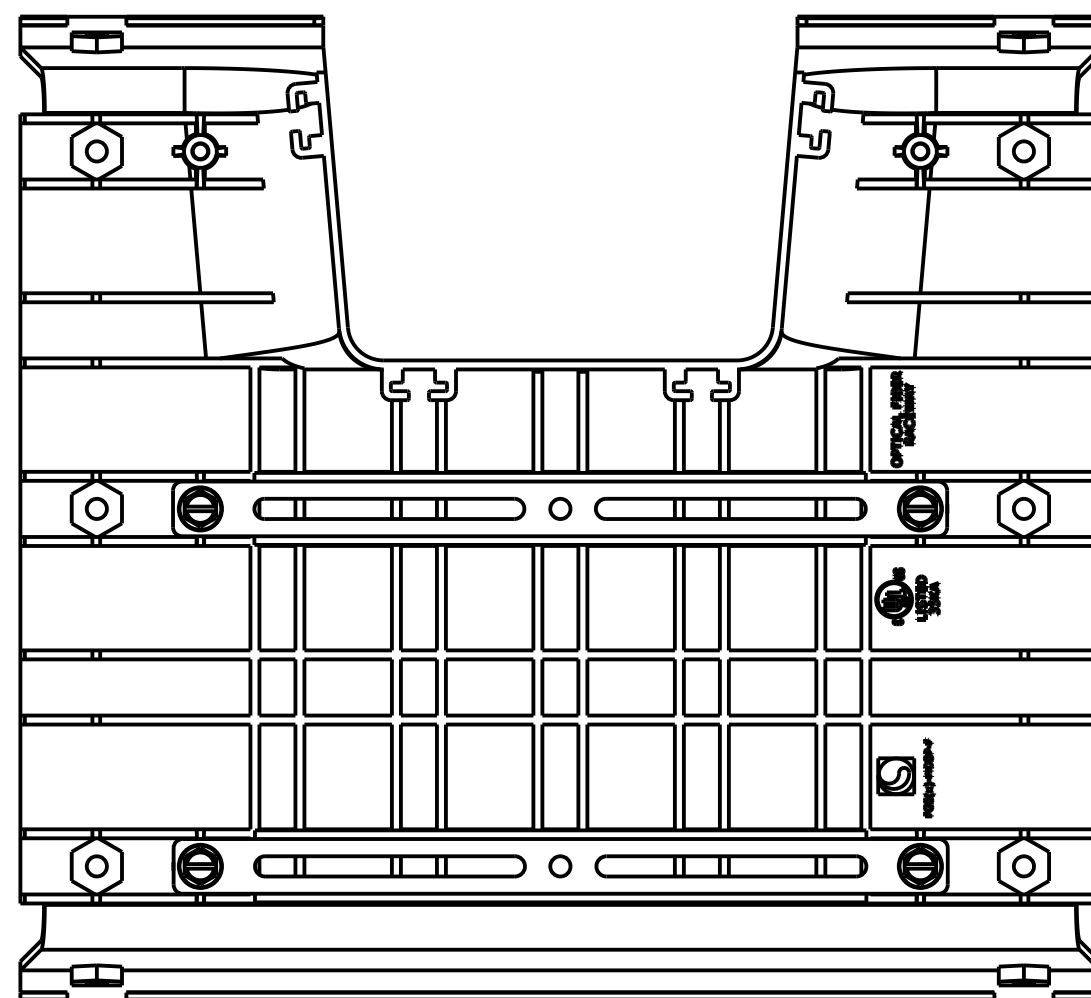

DETAIL F
12" DOWNSPOUT
SCALE 0.375

COMMSCOPE, INC.

<small>© 2016 COMMSCOPE, INC. CONFIDENTIAL NOTICE: THESE DRAWINGS AND SPECIFICATIONS ARE THE PROPRIETARY PROPERTY OF COMMSCOPE, INC. AND MAY BE USED ONLY FOR THE SPECIFIC PURPOSE AUTHORIZED IN WRITING BY COMMSCOPE, INC.</small>		TITLE 12" FGS VARIABLE SUPPORT BRACKET KITS	
<small>ALL DIMS AND TOLERANCES ARE INCHES UNLESS OTHERWISE SPECIFIED</small>	<small>.XX:±N/A .XXX:±N/A ANGULAR:±N/A</small>	C SIZE DRAWING NUMBER 300100114140	B REV
DO NOT SCALE DRAWING		ENGR: RUBEN ARVILLA DWN: VICTOR FLORES	SHT. 3 OF 4

DIMENSIONS IN INCHES
THIRD ANGLE PROJECTION

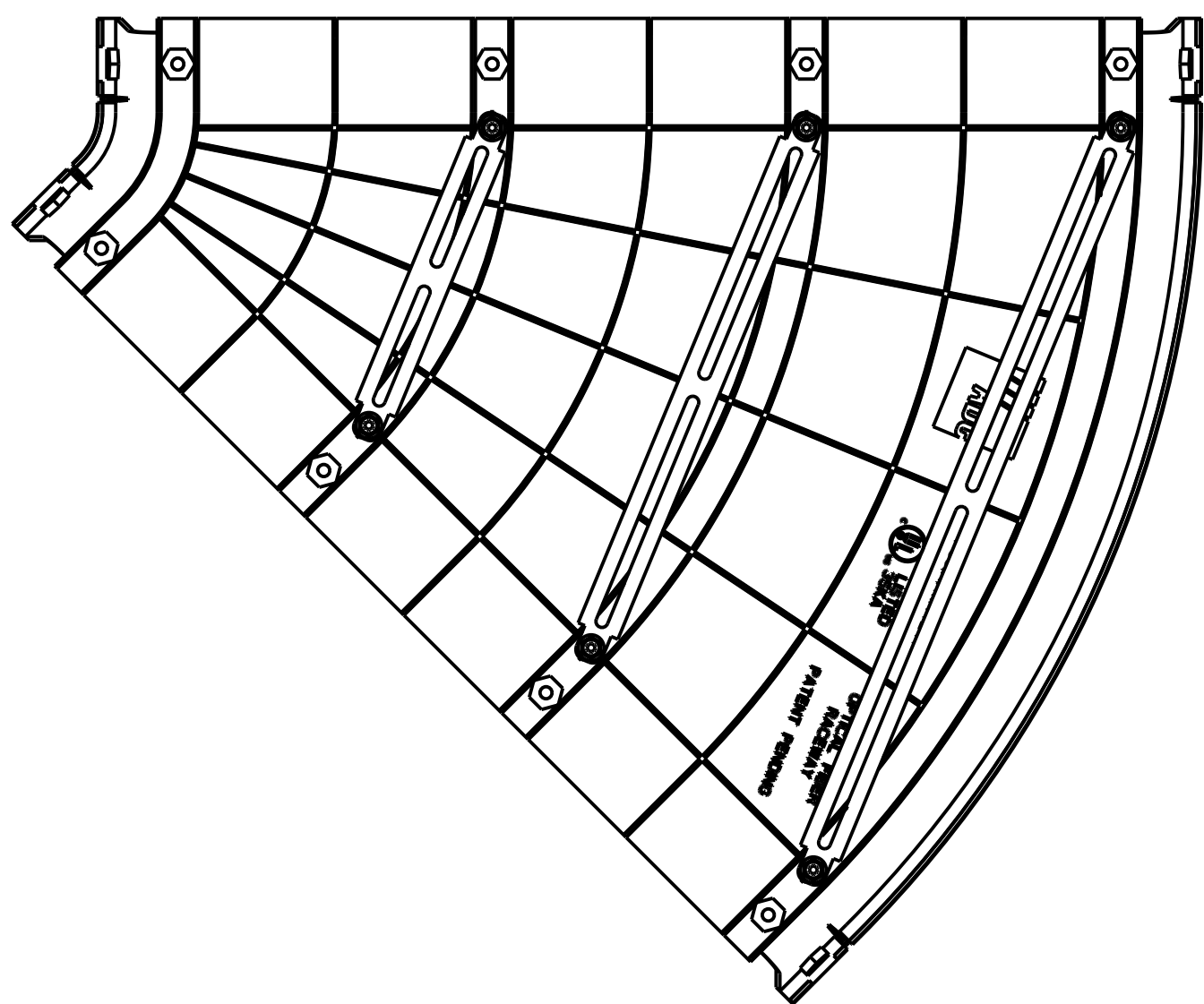

DETAIL G
24" 45° HORIZONTAL ELBOW
SCALE 0.250

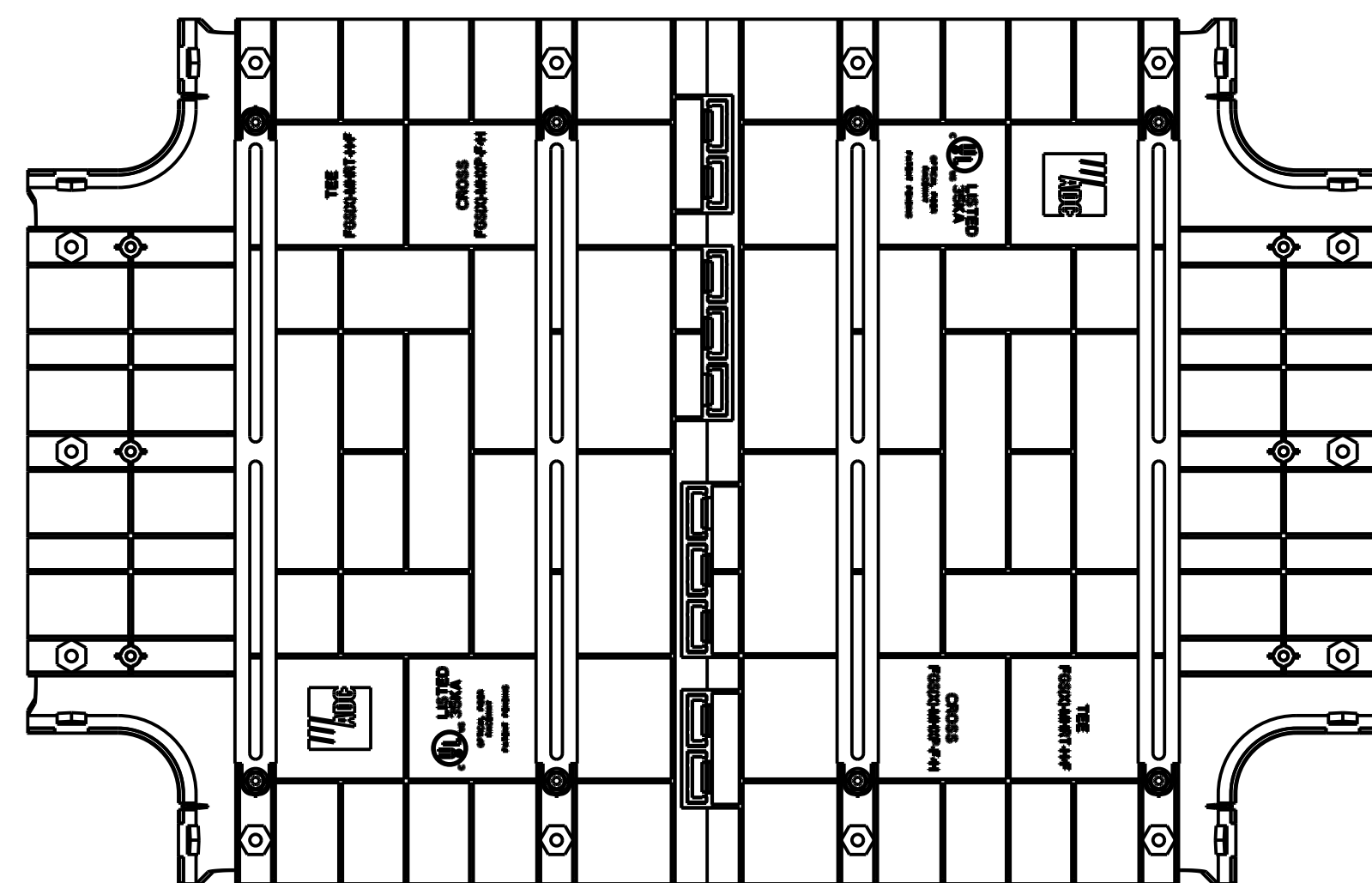

DETAIL J
24" CROSS, 12" EXIT
SCALE 0.250

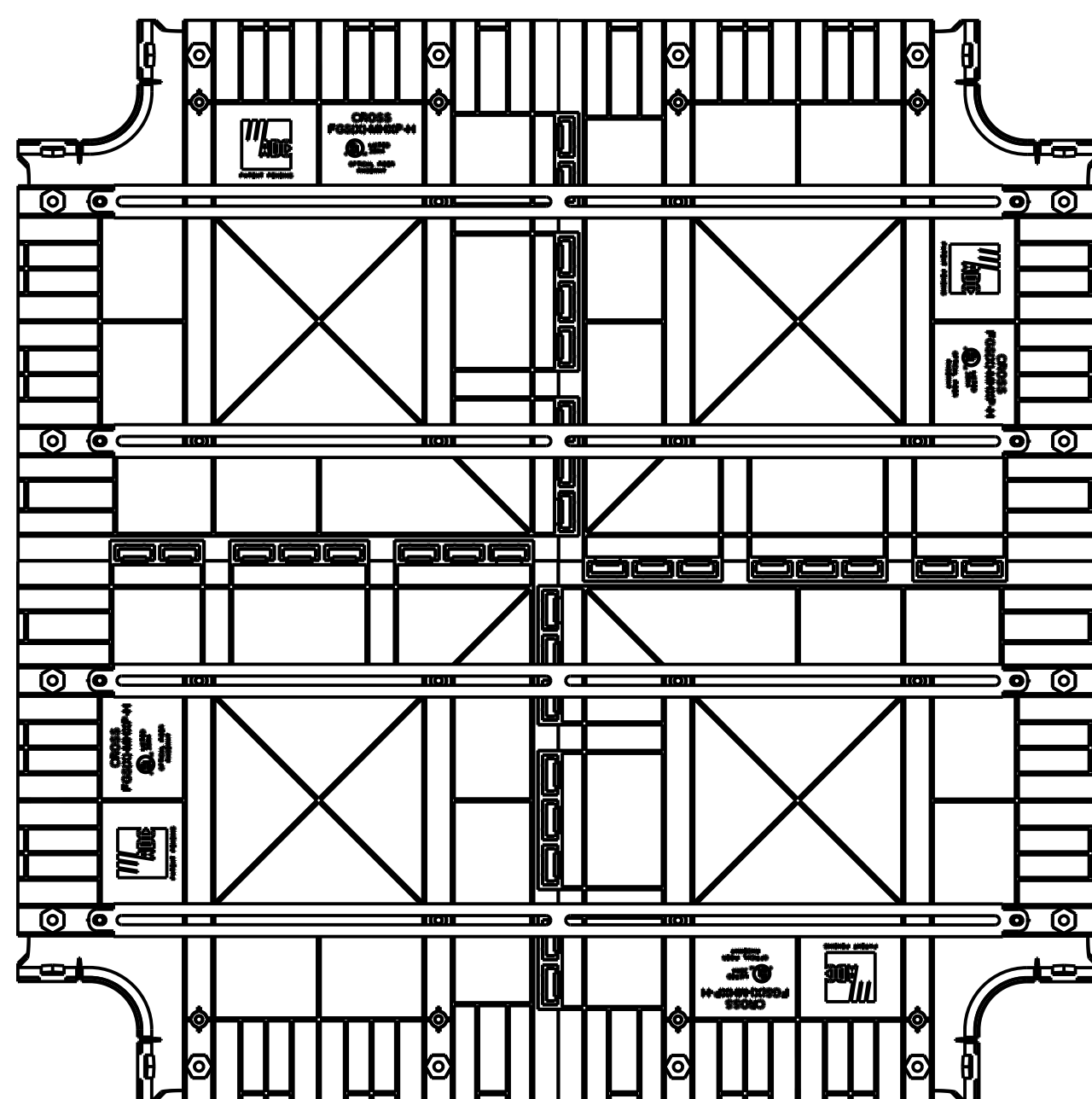

DETAIL K
24" CROSS
SCALE 0.200

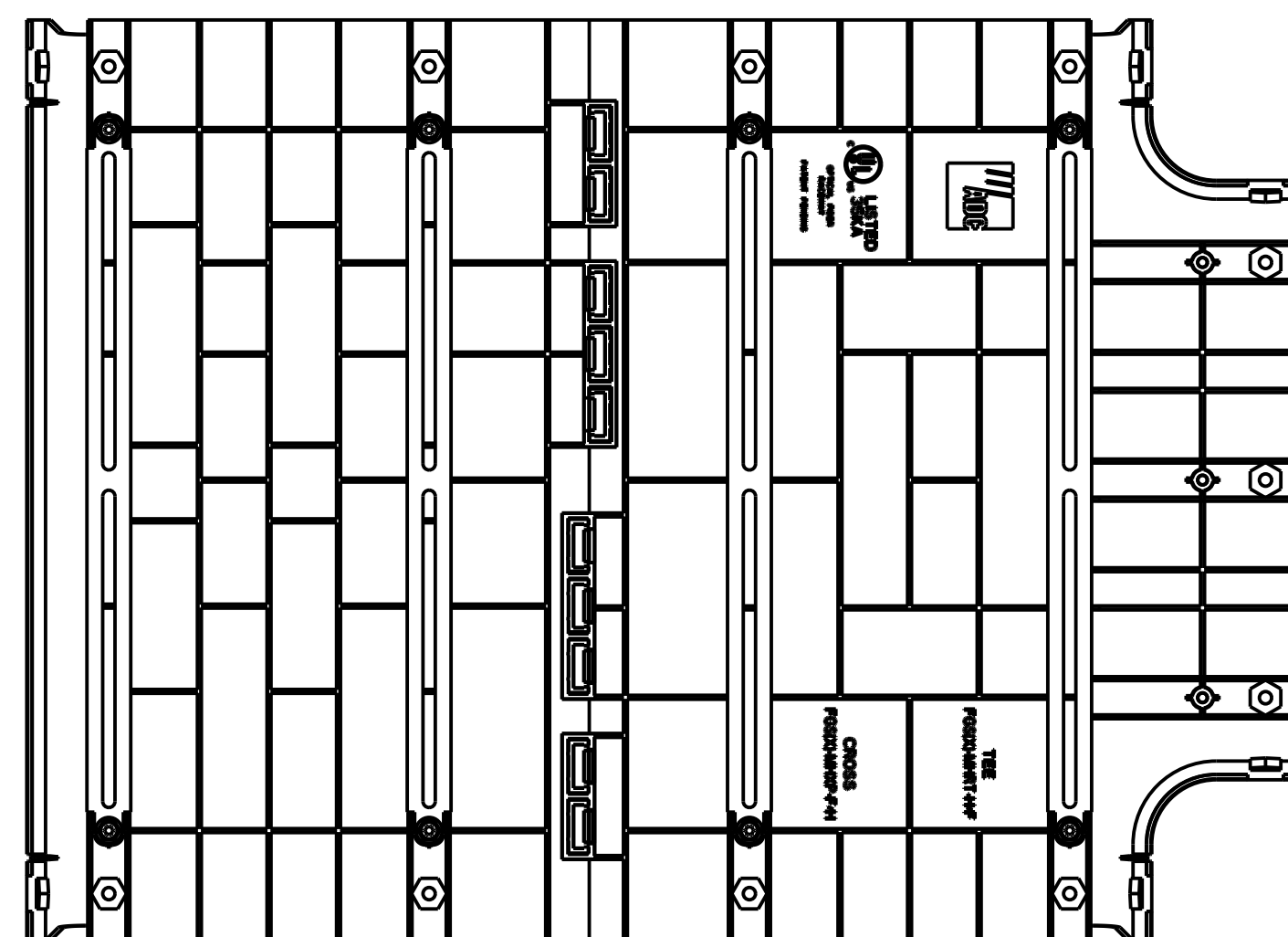

DETAIL H
24" TEE, 12" EXIT
SCALE 0.250

COMMSCOPE, INC.

© 2016 COMMSCOPE, INC. CONFIDENTIAL
NOTICE: THESE DRAWINGS AND SPECIFICATIONS
ARE THE PROPRIETARY PROPERTY OF
COMMSCOPE, INC. AND MAY BE USED ONLY FOR THE
SPECIFIC PURPOSE AUTHORIZED IN WRITING BY
COMMSCOPE, INC.

ALL DIMS AND TOLERANCES .XX:±N/A
ARE INCHES UNLESS .XXX:±N/A
OTHERWISE SPECIFIED ANGULAR:±N/A

DO NOT SCALE DRAWING

TITLE 12" FGS VARIABLE
SUPPORT BRACKET KITS

DRAWING NUMBER 300100114140

ENGR: RUBEN ARVILLA
DWN: VICTOR FLORES

SHT. 4 OF 4

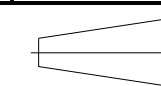
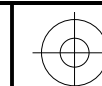

DIMENSIONS IN INCHES
THIRD ANGLE PROJECTION