

ITEM	PART NO.	DESCRIPTION	QTY.	WEIGHT
1	EQP6C041201	12' Platform Channel Side	2	97.15 LBS
2	MTCPCC10.01	10' Platform Channel Center	5	79.15 LBS
3	MTCP.01	6" Channel Adapter Angle	10	3.18 LBS
4	GB-05205	5/8" X 2" GALV BOLT KIT	40	0.27 LBS
5	GWF-05	5/8" GALV FLAT WASHER	80	0.06 LBS
6	MTC9683.29	24" X 144" BAR GRATING	5	171.26 LBS
7	GCM03	GRATING CLIP	35	0.39 LBS

REVISIONS				
REV.	ZONE	DESCRIPTION	BY	DATE
A		INITIAL RELEASE	MSM	02/15/12

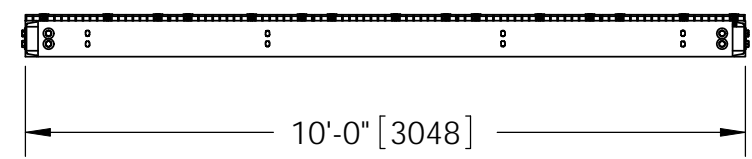
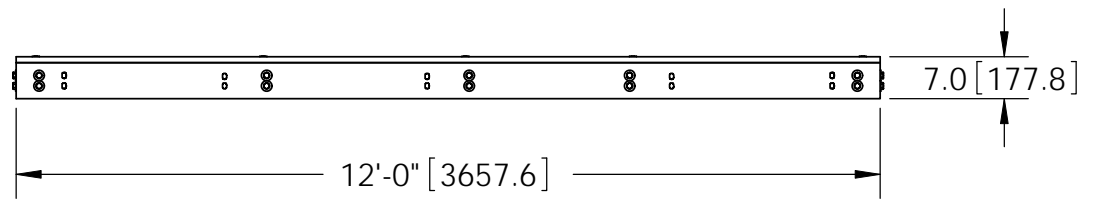
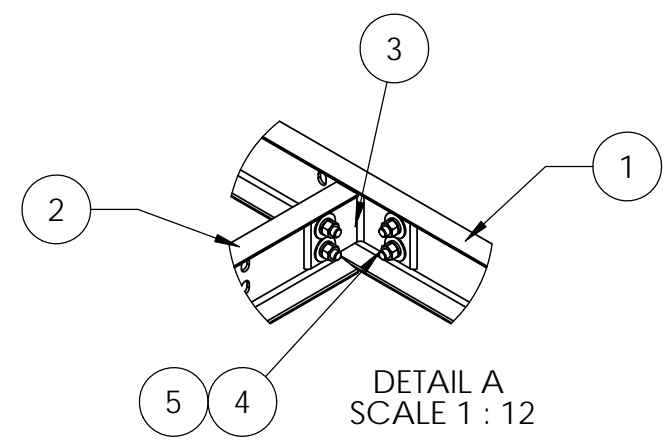
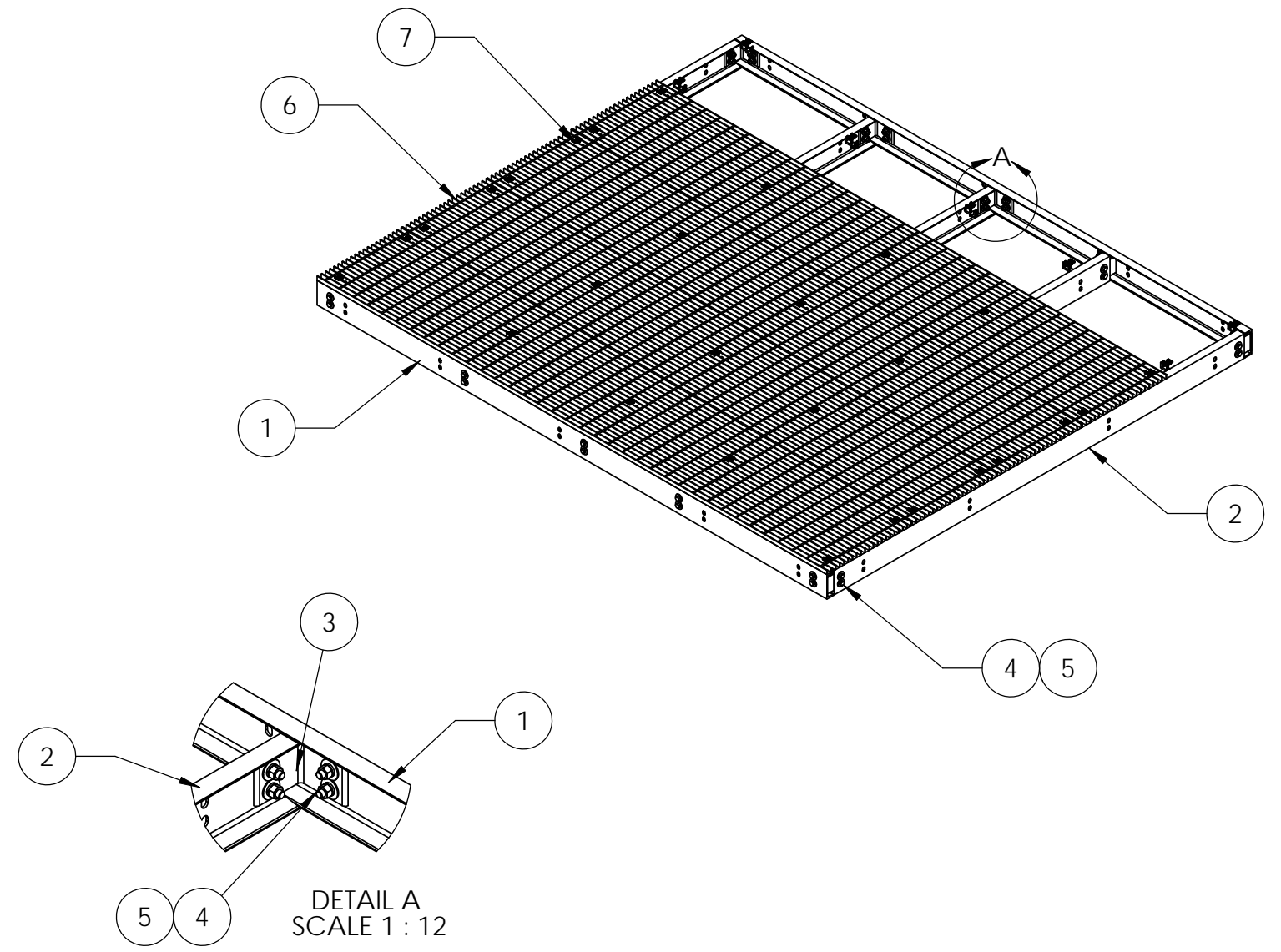
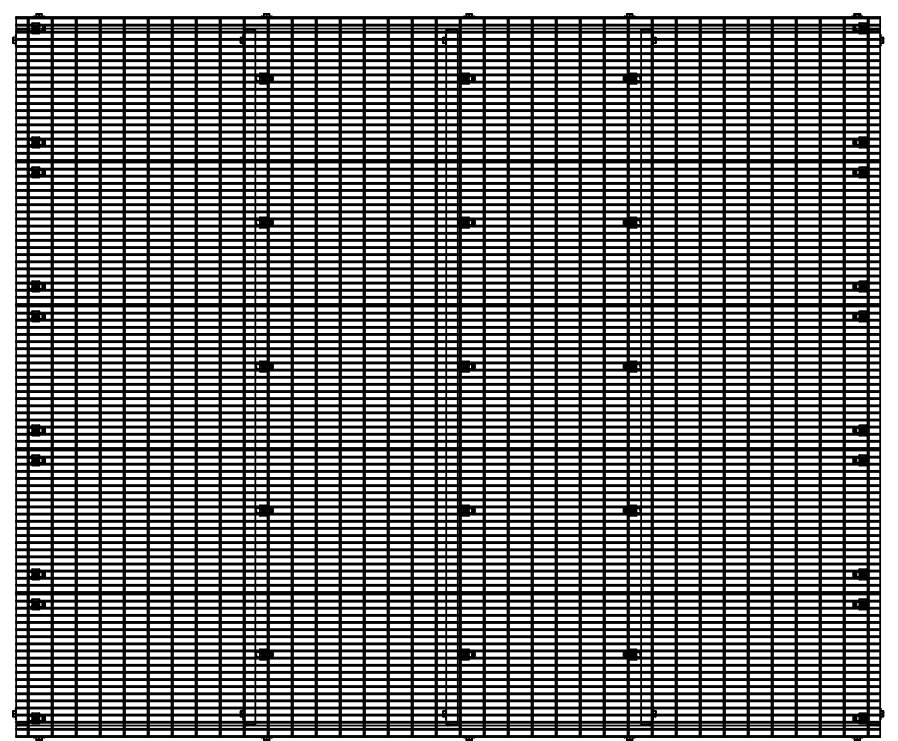

NOTES:
 1. ALL METRIC DIMENSIONS ARE IN BRACKETS.
 2. GRATING REMOVED FOR CLARITY.

These drawings and specifications are the proprietary property of CommScope Inc. and may be used only for the specific purpose authorized in writing by CommScope Inc. ALL DIMENSIONS ARE IN INCHES U.O.S. TOLERANCES UNLESS OTHERWISE SPECIFIED: .X = ± .12 ANGLES ±2° .XX = ± .06 FRACTIONS ±1/32 .XXX = ± .03 REMOVE BURRS AND BREAK EDGES .005 DO NOT SCALE THIS PRINT	DRAWN BY: MSM	SHEET: 1 of 1	PART NUMBER: EQ-P6C1012-B
	CHECKED BY: TP	SCALE: NTS	DESCRIPTION: 10' X 12' Equipment Platform 6" Channel
	DATE: 02/15/12	MATERIAL: A36, A568, A529	DRAWING TYPE: ASSEMBLY DRAWING
	REVISION: A	FINISH: GALV A123	WEIGHT: 1511.31 LBS