

LS2-XMHM-3M-P



LSF2-50 SureFlex® Jumper with interface types NEX10 Male and 4.3-10 Male, 3m

- WARNING: DO NOT MATE WITH 4.1-9.5 DIN

Product Classification

Product Type	Wireless transmission cable assembly
Product Series	LSF2-50

General Specifications

Body Style, Connector A	Straight
Body Style, Connector B	Straight
Interface, Connector A	NEX10 Male
Interface, Connector B	4.3-10 Male
Specification Sheet Revision Level	A

Dimensions

Length	3 m 9.843 ft
Nominal Size	3/8 in

Electrical Specifications

3rd Order IMD	-116 dBm
3rd Order IMD Test Method	Two +43 dBm carriers

VSWR/Return Loss

Frequency Band	VSWR	Return Loss (dB)
698–960 MHz	1.065	30.04
1700–2200 MHz	1.083	27.99
2500–2700 MHz	1.106	25.96
3400–3800 MHz	1.222	20.01

LS2-XMHM-3M-P

Jumper Assembly Sample Label



Environmental Specifications

Immersion Test Method

Meets IEC 60529:2001, IP68 in mated condition

Included Products

- LS2XM-P – NEX10 Male for 3/8 in LSF2-50 cable, factory attached
- LSF2-50 – LSF2-50, HELIAX® Superflexible Foam Coaxial Cable, corrugated copper, 3/8 in, black PE jacket (Not for Individual Sale - Jumpers only)
- P4HM-S2 – 4.3-10 Male for 3/8 in LSF2-50 cable, factory attached

LS2XM-P



NEX10 Male for 3/8 in LSF2-50 cable, factory attached

Product Classification

Product Type	Wireless and radiating connector
Product Brand	HELIAX®
Product Series	LSF2-50

General Specifications

Body Style	Straight
Cable Family	LSF2-50
Inner Contact Attachment Method	Solder
Inner Contact Plating	Silver
Interface	NEX10 Male
Outer Contact Attachment Method	Solder
Outer Contact Plating	Trimetal

Dimensions

Length	33 mm 1.299 in
Diameter	14.9 mm 0.587 in
Nominal Size	3/8 in

Outline Drawing

LS2XM-P

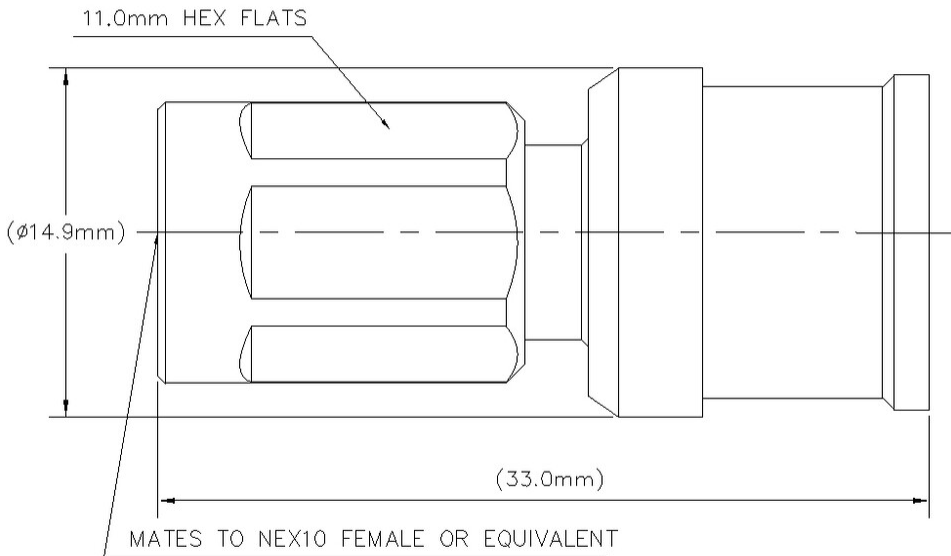

Electrical Specifications

3rd Order IMD at Frequency	-119 dBm @ 910 MHz
3rd Order IMD Test Method	Two +43 dBm carriers
Insertion Loss, typical	0.05 dB
Cable Impedance	50 ohm
Connector Impedance	50 ohm
dc Test Voltage	1500 V
Inner Contact Resistance, maximum	2 mOhm
Insulation Resistance, minimum	5000 MOhm
Operating Frequency Band	0 – 6000 MHz
Outer Contact Resistance, maximum	1 mOhm
Peak Power, maximum	5 kW

VSWR/Return Loss

Frequency Band	VSWR	Return Loss (dB)
698–970 MHz	1.029	36.9
1700–2700 MHz	1.058	31

LS2XM-P

3000–6000 MHz 1.222 20.01

Mechanical Specifications

Connector Retention Tensile Force	200.17 N 45 lbf
Connector Retention Torque	23.9 in lb 2.7 N-m
Coupling Nut Proof Torque	5 N-m 44.254 in lb
Coupling Nut Retention Force	500 N 112.405 lbf
Interface Durability	100 cycles
Mechanical Shock Test Method	IEC 60068-2-27

Environmental Specifications

Operating Temperature	-55 °C to +85 °C (-67 °F to +185 °F)
Storage Temperature	-65 °C to +125 °C (-85 °F to +257 °F)
Corrosion Test Method	IEC 60068-2-11
Immersion Depth	1 m
Immersion Test Mating	Mated
Immersion Test Method	IEC 60529:2001, IP68
Moisture Resistance Test Method	IEC 60068-2-3
Thermal Shock Test Method	IEC 60068-2-14
Vibration Test Method	IEC 60068-2-6

Packaging and Weights

Weight, net	17.61 g 0.039 lb
--------------------	--------------------

* Footnotes

Insertion Loss, typical	0.05√freq (GHz) (not applicable for elliptical waveguide)
Immersion Depth	Immersion at specified depth for 24 hours

LSF2-50



LSF2-50, HELIAX® Superflexible Foam Coaxial Cable, corrugated copper, 3/8 in, black PE jacket (Not for Individual Sale - Jumpers only)

Product Classification

Product Type	Coaxial wireless cable
Product Brand	HELIAX® SureFlex®
Product Series	LSF2-50 MLOC
Ordering Note	CommScope® standard product (Global)

General Specifications

Flexibility	Superflexible
Jacket Color	Black
Performance Note	Attenuation values typical, guaranteed within 5%

Dimensions

Diameter Over Dielectric	7.645 mm 0.301 in
Diameter Over Jacket	11.024 mm 0.434 in
Inner Conductor OD	3.048 mm 0.12 in
Outer Conductor OD	9.906 mm 0.39 in
Nominal Size	3/8 in

Electrical Specifications

Cable Impedance	50 ohm ±1 ohm
Capacitance	80.7 pF/m 24.597 pF/ft
dc Resistance, Inner Conductor	3.65 ohms/km 1.113 ohms/kft
dc Resistance, Outer Conductor	4.64 ohms/km 1.414 ohms/kft
dc Test Voltage	2500 V
Inductance	0.202 µH/m 0.062 µH/ft

LSF2-50

Insulation Resistance	100000 MOhms-km
Jacket Spark Test Voltage (rms)	5000 V
Operating Frequency Band	1 – 10200 MHz
Peak Power	15.6 kW
Velocity	82 %

VSWR/Return Loss

Frequency Band	VSWR	Return Loss (dB)
680–800 MHz	1.201	20.79
800–960 MHz	1.201	20.79
1700–2200 MHz	1.201	20.79
2300–2700 MHz	1.201	20.79
3400–3800 MHz	1.201	20.79

Attenuation

Frequency (MHz)	Attenuation (dB/100 m)	Attenuation (dB/100 ft)	Average Power (kW)
1.0	0.422	0.129	15.6
1.5	0.501	0.153	15.6
2.0	0.567	0.173	14.27
10.0	1.179	0.359	6.86
20.0	1.641	0.5	4.93
30.0	1.998	0.609	4.05
50.0	2.567	0.782	3.15
85.0	3.342	1.019	2.42
88.0	3.4	1.036	2.38
100.0	3.625	1.105	2.23
108.0	3.768	1.148	2.15
150.0	4.447	1.355	1.82
174.0	4.795	1.461	1.69
200.0	5.147	1.569	1.57
204.0	5.199	1.585	1.56
300.0	6.336	1.931	1.28
400.0	7.351	2.241	1.1
450.0	7.815	2.382	1.03
460.0	7.905	2.409	1.02

LSF2-50

500.0	8.257	2.517	0.98
512.0	8.36	2.548	0.97
600.0	9.084	2.769	0.89
700.0	9.851	3.003	0.82
800.0	10.572	3.222	0.77
824.0	10.739	3.273	0.75
894.0	11.214	3.418	0.72
960.0	11.648	3.55	0.69
1000.0	11.904	3.628	0.68
1218.0	13.231	4.033	0.61
1250.0	13.417	4.089	0.6
1500.0	14.806	4.512	0.55
1700.0	15.848	4.83	0.51
1794.0	16.32	4.974	0.5
1800.0	16.35	4.983	0.49
2000.0	17.321	5.279	0.47
2100.0	17.791	5.423	0.45
2200.0	18.253	5.563	0.44
2300.0	18.706	5.701	0.43
2500.0	19.589	5.97	0.41
2700.0	20.445	6.231	0.4
3000.0	21.682	6.608	0.37
3400.0	23.26	7.089	0.35
3600.0	24.022	7.321	0.34
3700.0	24.396	7.436	0.33
3800.0	24.767	7.549	0.33
3900.0	25.134	7.661	0.32
4000.0	25.498	7.771	0.32
4100.0	25.858	7.881	0.31
4200.0	26.215	7.99	0.31
4300.0	26.569	8.098	0.3
4400.0	26.92	8.205	0.3
4500.0	27.267	8.311	0.3
4600.0	27.612	8.416	0.29
4700.0	27.954	8.52	0.29

LSF2-50

4800.0	28.294	8.623	0.29
4900.0	28.63	8.726	0.28
5000.0	28.965	8.828	0.28
6000.0	32.183	9.809	0.25
8000.0	38.096	11.611	0.21
8800.0	40.314	12.287	0.2
10000.0	43.516	13.263	0.19

Material Specifications

Dielectric Material	Foam PE
Jacket Material	PE
Inner Conductor Material	Copper-clad aluminum wire
Outer Conductor Material	Corrugated copper

Mechanical Specifications

Minimum Bend Radius, multiple Bends	25.4 mm 1 in
Minimum Bend Radius, single Bend	25.4 mm 1 in
Number of Bends, minimum	15
Tensile Strength	118 kg 260.145 lb
Bending Moment	2.2 N-m 19.472 in lb
Flat Plate Crush Strength	2 kg/mm 111.995 lb/in

Environmental Specifications

Installation temperature	-40 °C to +60 °C (-40 °F to +140 °F)
Operating Temperature	-55 °C to +85 °C (-67 °F to +185 °F)
Storage Temperature	-70 °C to +85 °C (-94 °F to +185 °F)
Attenuation, Ambient Temperature	68 °F 20 °C
Average Power, Ambient Temperature	104 °F 40 °C
Average Power, Inner Conductor Temperature	212 °F 100 °C
EN50575 CPR Cable EuroClass Fire Performance	Fca

Packaging and Weights

Cable weight	0.11 kg/m 0.074 lb/ft
---------------------	-------------------------

LSF2-50

Regulatory Compliance/Certifications

Agency

CENELEC

ISO 9001:2015

**Classification**

EN 50575 compliant, Declaration of Performance (DoP) available

Designed, manufactured and/or distributed under this quality management system

P4HM-S2



4.3-10 Male for 3/8 in LSF2-50 cable, factory attached

Product Classification

Product Type	Wireless and radiating connector
Product Brand	HELIAX®

General Specifications

Body Style	Straight
Cable Family	FSJ4-50B
Inner Contact Attachment Method	Solder
Inner Contact Plating	Silver
Interface	4.3-10 Male
Outer Contact Attachment Method	Solder
Outer Contact Plating	Trimetal

Dimensions

Length	20.07 mm 0.79 in
Diameter	23.88 mm 0.94 in
Nominal Size	3/8 in

Outline Drawing

P4HM-S2

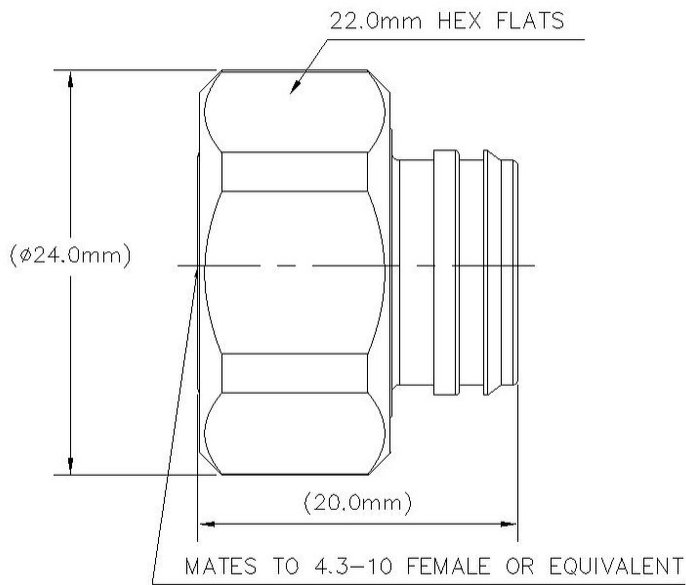

Electrical Specifications

3rd Order IMD at Frequency	-119 dBm @ 910 MHz
3rd Order IMD Test Method	Two +43 dBm carriers
Insertion Loss, typical	0.05 dB
Cable Impedance	50 ohm
Connector Impedance	50 ohm
dc Test Voltage	2500 V
Inner Contact Resistance, maximum	1 mOhm
Insulation Resistance, minimum	5000 MOhm
Operating Frequency Band	0 – 6000 MHz
Outer Contact Resistance, maximum	1 mOhm
Peak Power, maximum	15 kW

VSWR/Return Loss

Frequency Band	VSWR	Return Loss (dB)
0-3.8 GHz	1.023	38.89
3.8-6 GHz	1.041	33.94

P4HM-S2

Mechanical Specifications

Connector Retention Tensile Force	200.17 N 45 lbf
Connector Retention Torque	2.7 N-m 23.897 in lb
Coupling Nut Proof Torque	8 N-m 70.806 in lb
Coupling Nut Retention Force	449.98 N 101.16 lbf
Interface Durability	100 cycles
Mechanical Shock Test Method	IEC 60068-2-27

Environmental Specifications

Operating Temperature	-55 °C to +85 °C (-67 °F to +185 °F)
Storage Temperature	-65 °C to +125 °C (-85 °F to +257 °F)
Attenuation, Ambient Temperature	20 °C 68 °F
Average Power, Ambient Temperature	40 °C 104 °F
Corrosion Test Method	IEC 60068-2-11
Immersion Depth	1 m
Immersion Test Mating	Mated
Immersion Test Method	IEC 60529:2001, IP68
Moisture Resistance Test Method	IEC 60068-2-3
Thermal Shock Test Method	IEC 60068-2-14
Vibration Test Method	IEC 60068-2-6

Packaging and Weights

Weight, net	25.45 g 0.056 lb
--------------------	--------------------

Regulatory Compliance/Certifications

Agency	Classification
CHINA-ROHS	Below maximum concentration value
ISO 9001:2015	Designed, manufactured and/or distributed under this quality management system
REACH-SVHC	Compliant as per SVHC revision on www.commscope.com/ProductCompliance
ROHS	Compliant



P4HM-S2

* Footnotes

Insertion Loss, typical $0.05\sqrt{\text{freq}}$ (GHz) (not applicable for elliptical waveguide)

Immersion Depth Immersion at specified depth for 24 hours