

EQ-HR1015

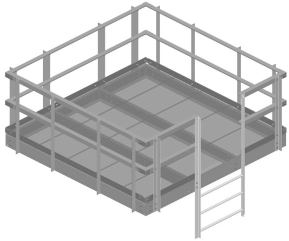

Handrail Kit for 10 ft x 15 ft equipment platform

Product Classification

Product Type Equipment platform system

General Specifications

Mounting EQ series platform bases

Dimensions

Height 1,219.2 mm | 48 in

Width 3048 mm | 120 in

Length 4572 mm | 180 in

EQ-HR1015

Outline Drawing

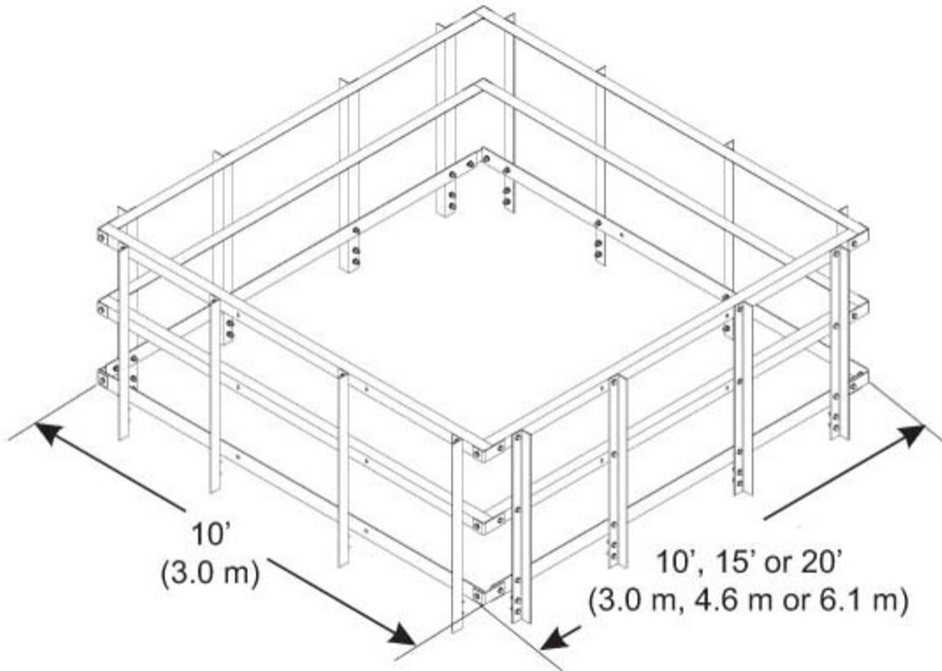

Material Specifications

Material Type Hot dip galvanized steel

Packaging and Weights

Included Angle brackets | Hardware | Posts

Packaging quantity 1

Weight, net 401.9 kg | 886.037 lb

Regulatory Compliance/Certifications

Agency

ISO 9001:2015

Classification

Designed, manufactured and/or distributed under this quality management system