

WB-K110-B



Safety Grated Waveguide Bridge Kit, 12 in x 10 ft, with two 13 ft 4 in direct burial posts

Product Classification

Product Type Waveguide bridge kit

General Specifications

Application Direct burial

Cable Runs, quantity 12

Pipe, quantity 2

Dimensions

Height 4064 mm | 160 in

Width 304.8 mm | 12 in

Length 3048 mm | 120 in

Pipe Length 4,053.84 mm | 159.6 in

WB-K110-B

Outline Drawing

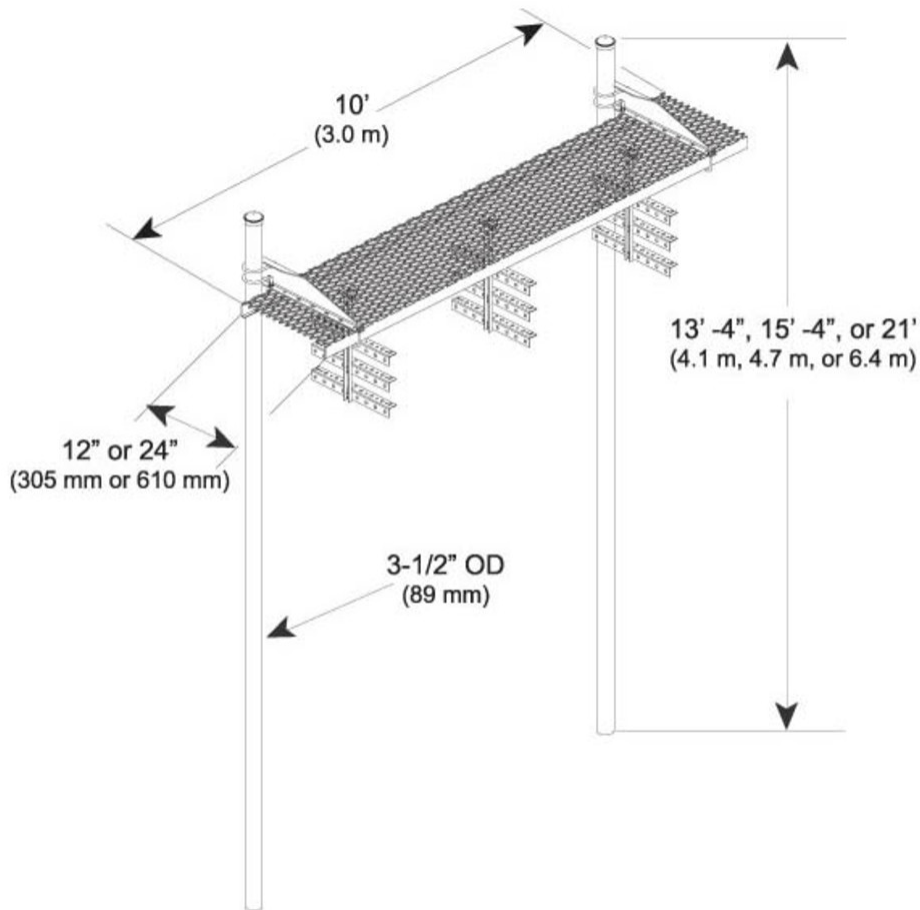

Material Specifications

Material Type Hot dip galvanized steel

Packaging and Weights

Included Caps | Channel | Hardware | Posts | Support brackets | Trapeze

Packaging quantity 1

Weight, net 147.4 kg | 324.961 lb

Regulatory Compliance/Certifications

Agency **Classification**

WB-K110-B

CHINA-ROHS	Above maximum concentration value
ISO 9001:2015	Designed, manufactured and/or distributed under this quality management system
ROHS	Compliant/Exempted
UK-ROHS	Compliant/Exempted



Included Products

- MF-130 – Direct Burial Pipe Column, 13 ft 4 in
- WB-CY110 – Safety Grated Waveguide Bridge Channel, 12 in x 10 ft
- WB-LB12-3 – Waveguide Bridge Support Bracket, 12 in wide for 3-1/2 in OD legs
- WB-T12-3 – Trapeze Kit, triple tee, 12 in wide, three rungs