

# HST-B8HNC0100NN000



HST, NOVUX™ Hardened Standard Terminal, 8-port, Armored cable, 100 ft/30 m

- NOVUX™ Hardened Multi-fiber Terminals incorporate hardened connector technology that is designed to withstand the rugged outside plant environment
- Hardened connectors are factory-integrated and environmentally sealed for use in optical drop cable deployments
- Plug and play adapter ports ensure rapid cable installment in the outside plant access section of the network
- NOVUX™ HST terminals are available with 2 to 12 ports and can be utilized in Single Fiber Point-to-Point (P2P) solutions
- Available with flat dielectric, flat toneable/locatable dielectric, armored or 5mm round cable
- NOVUX™ smaller terminal size for aesthetics and allowing installation in constrained spaces
- NOVUX™ terminals are available in Black (RAL# 9005) or Gray (RAL# 7035)
- CommScope Product ID plate with QR code link to product documents and C-Track

## Product Classification

<b>Regional Availability</b>	Asia   EMEA   Latin America   North America
<b>Product Type</b>	Access terminal, without splitter/tap
<b>Product Brand</b>	NOVUX™
<b>Product Series</b>	HST
<b>Minimum Order Quantity</b>	1

## General Specifications

<b>Cable Type</b>	Armored - Round - Loose Tube
<b>Cable, quantity</b>	1
<b>Distribution Type</b>	8 ports
<b>Drop Port Type</b>	Hardened full-size SC/APC
<b>Drop Port, quantity</b>	8
<b>Enclosure Color</b>	Black (RAL 9005)
<b>Mounting</b>	Handhole   Pedestal   Pole   Strand
<b>Port Type</b>	Hardened full-size SC/APC
<b>Port, quantity</b>	8
<b>Stub Type</b>	Stub tail

## Dimensions

# HST-B8HNC0100NN000

<b>Height</b>	80 mm   3.15 in
<b>Width</b>	157 mm   6.181 in
<b>Length</b>	192 mm   7.559 in
<b>Cable Length, stub</b>	100 ft (30 m)
<b>Cable Outer Diameter</b>	3.0 mm (0.12 in) in

## Dimension Drawing

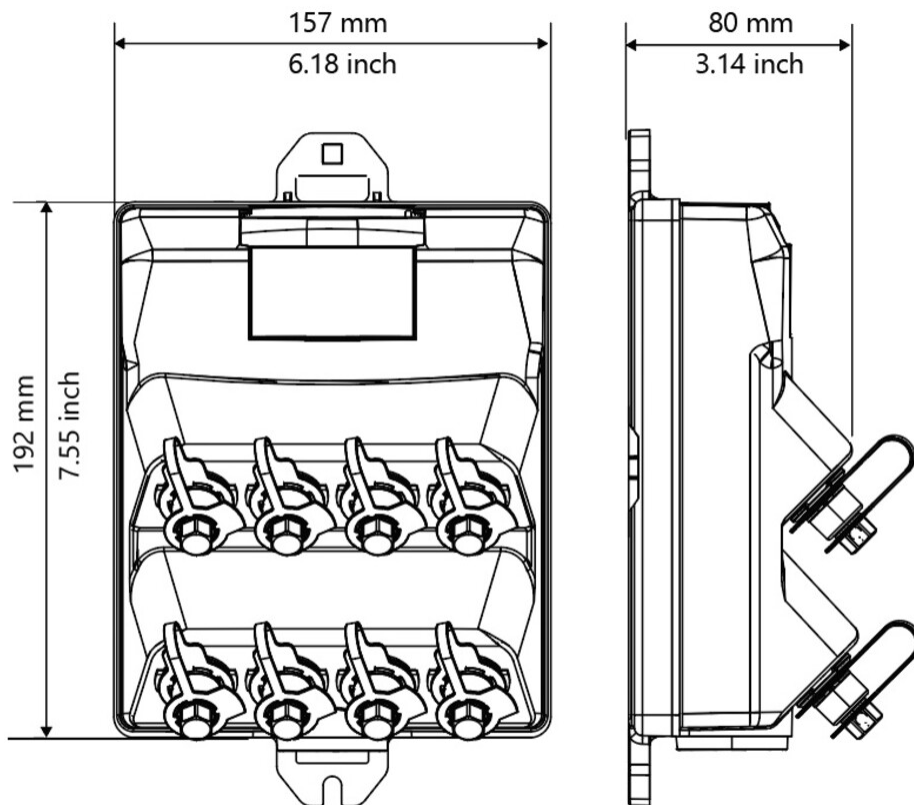

## Port Configuration

# HST-B8HNC0100NN000

NOVUX HT	TECHNOLOGIES AVAILABLE	SMALL	MEDIUM	LARGE	
HST Series	Single-fiber: P2P/no splitters	2 ports	6 ports	12 ports	
		4 ports	8 ports		
	Single-fiber: P2P w/splitters	2 ports, 1x1:2	8 ports, 2x1:4	12 ports, 3x1:4	
		4 ports, 1x1:4	8 ports, 1x1:8		
	Hybrid for multi-use			7 ports, 1x1:4 splitter, 3 P2P	12 ports, 1x1:8 splitter, 4 P2P
		4 ports, 1x1:2 splitter, 2 P2P	8 ports, 1x1:4 splitter, 4 P2P		11 ports, 2x1:4 splitter, 2 P2P, 1 HMFOC 4f

## Ordering Tree



## Material Specifications

### Enclosure Material Type

Hardened plastic

## Optical Specifications

### Fiber Type

G.657.A1/A2

### Operating Wavelength Range

1260 – 1635 nm

### Attenuation Single Ports, maximum

0.4 dB

### Attenuation Cable Coefficient, maximum

0.30 dB/km @ 1550 nm | 0.40 dB/km @ 1310 nm

### Return Loss, Connector, typical

65 dB

# HST-B8HNC0100NN000

---

## Environmental Specifications

<b>Operating Temperature</b>	-40 °C to +65 °C (-40 °F to +149 °F)
<b>Relative Humidity</b>	5%–100%, condensing
<b>Environmental Space</b>	Above ground   Below ground
<b>Qualification Standards</b>	IEC 60529, IP68 + 2 m waterhead   IEC 61753-1, category G   Telcordia GR-771-CORE
<b>UV Resistance</b>	UV stabilized

## Packaging and Weights

<b>Packaging quantity</b>	1
<b>Packaging Type</b>	Box   Coiled

## Regulatory Compliance/Certifications

<b>Agency</b>	<b>Classification</b>
CHINA-ROHS	Below maximum concentration value
ISO 9001:2015	Designed, manufactured and/or distributed under this quality management system
REACH-SVHC	Compliant as per SVHC revision on <a href="http://www.commscope.com/ProductCompliance">www.commscope.com/ProductCompliance</a>
ROHS	Compliant
UK-ROHS	Compliant

