

MHT-06H2H0U-A0500F

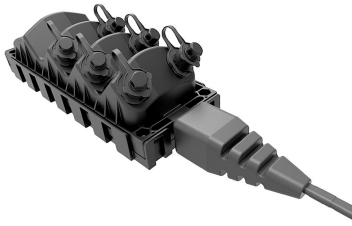

MHT Fiber Optic Multiport Service Terminal, 6-port, HMFOC, dielect. flat loose tube cable, HMFOC on stub end, 500 ft

- Hardened connectors are factory-terminated and environmentally sealed for use in optical drop cable deployments
- Plug and play adapter ports ensure rapid cable installment in the outside plant access section of the network
- Multiport Service Terminals incorporate hardened connector technology that is designed to withstand the rugged outside plant environment

Alternative products available:

HMT-B6M2A0500FU000 NOVUX™ Hardened Multi-fiber Terminal, 6 HMFOC ports, 2 fibers per port, Dielectric flat loose tube cable with HMFOC plug (female/no pin), 500 ft/152 m, with universal mounting bracket

Product Classification

Regional Availability	Latin America North America
Product Type	Access terminal, without splitter/tap
Product Series	MHT

General Specifications

Cable Type	Dielectric - Flat - Loose Tube
Cable, quantity	1
Distribution Type	6 ports
Enclosure Color	Black
Mounting	Handhole Pedestal Pole Strand
Port Type	Hardened multi-fiber (HMFOC) jack, male/pinned
Port, quantity	6
Splitter, quantity	0
Stub Type	Hardened multi-fiber (HMFOC) jack, pinned

Dimensions

Height	298 mm 11.732 in
Width	130.3 mm 5.13 in
Depth	89 mm 3.504 in

MHT-06H2H0U-A0500F

Cable Length, stub	500 ft (152 m)
Cable Outer Diameter	4.5 x 8.1 mm (0.18 x 0.32 in)

Dimension Drawing

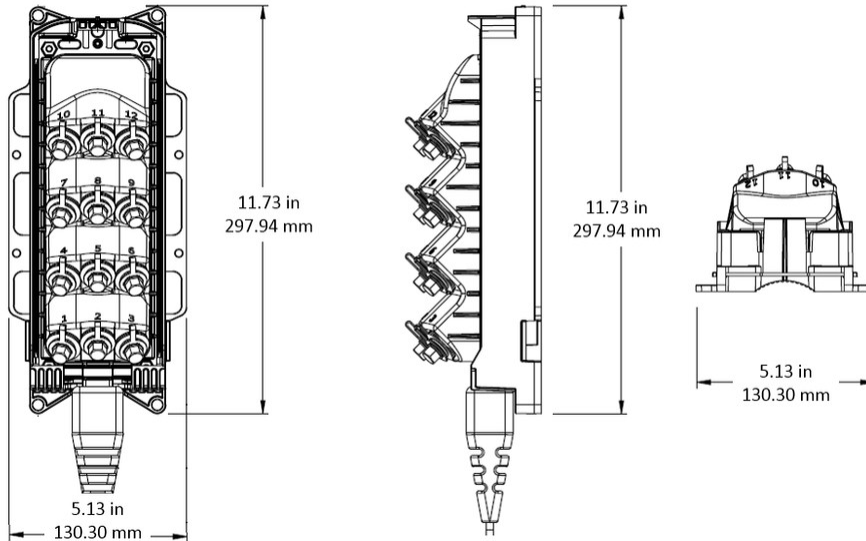

Ordering Tree

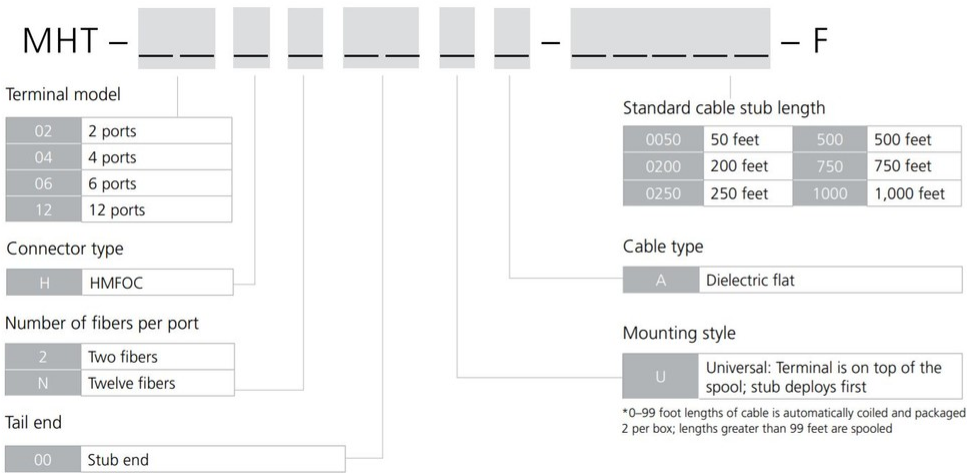

Material Specifications

Enclosure Material Type	Gasketed hardened plastic
--------------------------------	---------------------------

Optical Specifications

MHT-06H2H0U-A0500F

Fiber Type	G.657.A1/A2
Operating Wavelength Range	1260 – 1635 nm
Attenuation Cable Coefficient, maximum	0.30 dB/km @ 1550 nm 0.40 dB/km @ 1310 nm
Attenuation Terminal Connectors, maximum	0.45 dB
Directivity, minimum	60 dB
Insertion Loss, Terminal Connector, typical	0.16 dB
Return Loss, Connector, minimum	65 dB

Environmental Specifications

Operating Temperature	-40 °C to +70 °C (-40 °F to +158 °F)
Relative Humidity	5%–100%, condensing
Environmental Space	Above ground Below ground Buried
Flammability Rating	UL 94 V-0
Qualification Standards	IEC 60529, IP68 + 2 m waterhead Telcordia GR-3120-CORE Telcordia GR-326-CORE Telcordia GR-771-CORE
UV Resistance	UV stabilized

Packaging and Weights

Included	Enclosure (1) Universal mounting bracket (1)
Packaging quantity	1
Packaging Type	Box Carton
Weight, without cable	0.99 kg 2.183 lb

Regulatory Compliance/Certifications

Agency	Classification
CHINA-ROHS	Above maximum concentration value
ISO 9001:2015	Designed, manufactured and/or distributed under this quality management system
REACH-SVHC	Compliant as per SVHC revision on www.commscope.com/ProductCompliance
ROHS	Compliant/Exempted
UK-ROHS	Compliant



Included Products

MHT-06H2H0U-A0500F

MST-UMB-MINI – DLX® Mini-MST, Fiber Optic Universal Mounting Bracket