

# HMT-B2M2B0750FN000



NOVUX™ Hardened Multi-fiber Terminal, 2 HMFOC ports, 2 fibers per port, Flat toneable loose tube cable with HMFOC plug (female/no pin), 750 ft/228 m

- NOVUX™ Hardened Multi-fiber Terminals incorporate hardened connector technology that is designed to withstand the rugged outside plant environment
- Hardened connectors are factory-integrated and environmentally sealed for use in optical drop cable deployments
- Plug and play adapter ports ensure rapid cable installment in the outside plant access section of the network
- NOVUX™ HMT terminals are well suited for fiber-rich applications and available with 12 or 24 Fibers; no internal splitter option
- Available with flat dielectric up to 24 fiber or flat toneable/locatable up to 12 fiber. Terminals can be used as a distribution point within a network or as a final multifiber drop terminal where more than a single fiber is required to service an SFU or cellular tower
- NOVUX™ smaller terminal size for aesthetics and allowing installation in constrained spaces
- NOVUX™ terminals are available in Black (RAL# 9005) or Gray (RAL# 7035)
- CommScope Product ID plate with QR code link to product documents and C-Track

## Product Classification

|                               |   |
|-------------------------------|---|
| <b>Regional Availability</b>  | Asia   EMEA   Latin America   North America |
| <b>Product Type</b>           | Access terminal, without splitter/tap       |
| <b>Product Brand</b>          | NOVUX™                                      |
| <b>Product Series</b>         | HMT   |
| <b>Minimum Order Quantity</b> | 1   |

## General Specifications

|                                   |  |
|-----------------------------------|--|
| <b>Cable Type</b>                 | Toneable - Flat - Loose Tube                   |
| <b>Cable, quantity</b>            | 1  |
| <b>Distribution Type</b>          | 2 ports, 2 fibers per port                     |
| <b>Drop Port Type</b>             | Hardened multi-fiber (HMFOC) jack, male/pinned |
| <b>Enclosure Color</b>            | Black (RAL 9005)                               |
| <b>Multi-fiber Port Type</b>      | Hardened multi-fiber (HMFOC) jack, male/pinned |
| <b>Multi-fiber Port, quantity</b> | 2  |
| <b>Mounting</b>                   | Handhole   Pedestal   Pole   Strand            |
| <b>Port Type</b>                  | Hardened multi-fiber (HMFOC) jack, male/pinned |

# HMT-B2M2B0750FN000

|                           |  |
|---------------------------|--|
| <b>Port, quantity</b>     | 2  |
| <b>Stub Type</b>          | Hardened multi-fiber (HMFOC) plug, female/no pin |
| <b>Dimensions</b>         |  |
| <b>Height</b>             | 80 mm   3.15 in                                  |
| <b>Width</b>              | 79 mm   3.11 in                                  |
| <b>Length</b>             | 161 mm   6.339 in                                |
| <b>Cable Length, stub</b> | 750 ft (228 m)                                   |

## Dimension Drawing



## Port Configuration

| NOVUX HT   | TECHNOLOGIES AVAILABLE | SMALL                           | MEDIUM                   | LARGE             |
|------------|------------------------|---------------------------------|--------------------------|-------------------|
| HMT Series | Multi-fiber            | Up to 24f                       | Up to 24f                | Up to 24f         |
|            |                        | 2 ports, each 2, 4, 6, 8 or 12f | 6 ports, each 2, 3 or 4f | 12 ports, each 2f |
|            |                        | 3 ports, each 2, 4, 6, or 8f    | 8 ports 2 or 3f          |                   |
|            |                        | 4 ports, each 2, 4, or 6f       |                          |                   |

## Ordering Tree

# HMT-B2M2B0750FN000

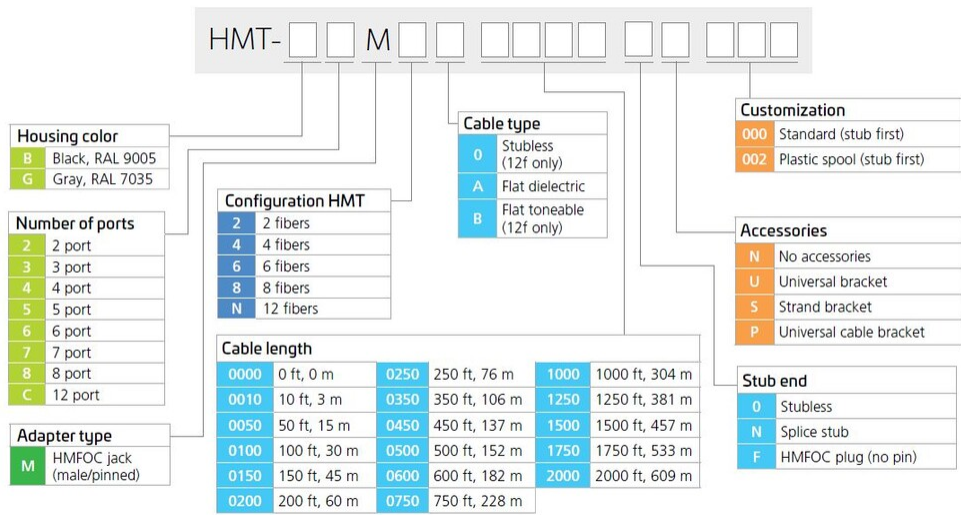

## Material Specifications

**Enclosure Material Type** Hardened plastic

## Optical Specifications

**Fiber Type** G.657.A1/A2

**Operating Wavelength Range** 1260 – 1635 nm

**Attenuation Single Ports, maximum** 0.65 dB

**Attenuation Cable Coefficient, maximum** 0.30 dB/km @ 1550 nm | 0.40 dB/km @ 1310 nm

**Insertion Loss, Stub Connector, maximum** 0.65 dB

**Return Loss, Connector, typical** 65 dB

## Environmental Specifications

**Operating Temperature** -40 °C to +65 °C (-40 °F to +149 °F)

**Relative Humidity** 5%–100%, condensing

**Environmental Space** Above ground | Below ground

**Qualification Standards** IEC 60529, IP68 + 2 m waterhead | IEC 61753-1, category G

**UV Resistance** UV stabilized

## Packaging and Weights

**Packaging quantity** 1

**Packaging Type** Box | Universal spool, wood: terminal is on the top of the spool, stub deploys

# HMT-B2M2B0750FN000

---

first

## Regulatory Compliance/Certifications

| <b>Agency</b> | <b>Classification</b>  |
|---------------|--|
| CHINA-ROHS    | Below maximum concentration value  |
| ISO 9001:2015 | Designed, manufactured and/or distributed under this quality management system   |
| REACH-SVHC    | Compliant as per SVHC revision on <a href="http://www.commscope.com/ProductCompliance">www.commscope.com/ProductCompliance</a> |
| ROHS          | Compliant  |
| UK-ROHS       | Compliant  |

