



# Multi-tenant Data Center System Selection Guide

For use in North America

COMMScope®





## INTRODUCTION

### **Turn your multi-tenant data center (colocation) infrastructure into a competitive advantage**

The multi-tenant data center (MTDC) arena is not for the faint of heart. Growth is explosive, the pace of change frenetic, and competition fierce. Driven by the growth of edge-based connectivity and new partnerships with hyperscale and cloud providers, the global colocation and wholesale market is projected to exceed \$54 billion in revenue by 2023, compared to \$38.2 billion in 2018.<sup>1</sup>

To compete successfully, MTDC owners and network managers need to be quick to market, globally agile and able to scale on demand. It all comes down to having a physical layer infrastructure designed for fast deployment, simplified management and flexible growth.

### **The fiber-dense connectivity customers want—the scalability and support you need**

Today's colocation and wholesale tenants are running faster, more demanding applications than ever before. They look to you for a fiber-dense backbone and flexible connectivity. That's why some of the world's largest MTDC providers look to CommScope.

With a world-leading portfolio of carrier-grade fiber connectivity and management solutions for the backbone and copper and fiber structured cabling solutions, we help you manage the exponential growth in your MTDC. From entrance facilities and cross-connects to the meet-me rooms and customer cages, CommScope supports the fiber-dense applications and migration agility you and your customers depend on.

### **Connections beyond the obvious**

We also keep you connected in other ways. Our powered fiber cabling solution remotely connects and powers a wide range of IP devices, nodes and sensors, while the FiberGuide® optical raceway solution connects, manages, distributes and protects your fiber plant across all areas of the data center. With CommScope's global manufacturing network and CommScope Express expedited delivery service, the world's most advanced fiber and copper connectivity solutions are never more than a week away from their final destination. So, you can satisfy your most demanding customers, wherever they are.

For MTDCs, future success starts with an adaptable, powerful and streamlined infrastructure. CommScope turns yours into a compelling and competitive advantage. Read on to learn how.

To compete successfully, MTDC owners and network managers need to be quick to market, globally agile and able to scale on demand.

<sup>1</sup> Global Colocation and Wholesale Datacenter Market to Exceed \$54 Billion by 2023; 451 Research; April 25, 2019.



## Direct System Selection

<b>Fiber Splice Systems</b> .....	<b>4</b>
<b>Fiber Entrance Cabinet (FEC)</b> .....	<b>5</b>
Fiber Entrance Cabinet (FEC) System Selection .....	6
Fiber Entrance Cabinet (FEC) Products .....	7
<b>FACT® Optical Distribution Frame (ODF)</b> .....	<b>8</b>
FACT® Optical Distribution Frame (ODF) Modular Design .....	9
FACT® Optical Distribution Frame (ODF) Products .....	10
<b>Universal Mount Splice Cabinet (UMSC)</b> .....	<b>13</b>
Universal Mount Splice Cabinet (UMSC) System Selection .....	14
Universal Mount Splice Cabinet (UMSC) Products .....	15
<b>Flex Frame ODF and 19-in. Propel Panels</b> .....	<b>16</b>
Flex Frame System Selection .....	17
Flex Frame Products .....	18
<b>FOSC® 600 Series</b> .....	<b>19</b>
FOSC® 600 Series System Selection and Products .....	20
<b>19-in. Splice Solutions</b> .....	<b>21</b>
19-in. Splice Solutions System Selection .....	21
19-in. Splice Solutions Products .....	22
Singlemode High Fiber Count Bulk Cables .....	24
<b>Rollable Ribbon Fiber Solutions</b> .....	<b>25</b>
Rollable Ribbon Fiber Technology .....	26
Rollable Ribbon and Stranded Fiber Cables .....	27
Fiber Cable Fixing Accessories .....	29
Singlemode Patch Cord and Cable Management Products .....	30
<b>Pre-terminated Fiber Systems</b> .....	<b>31</b>
<b>Pre-terminated 19-in. Fiber</b> .....	<b>32</b>
Pre-terminated 19-in. Fiber System Selection .....	32
Pre-terminated 19-in. Fiber System Products .....	33
Pre-terminated 19-in. Fiber System Cable Assemblies .....	35

<b>Pre-terminated FACT ODF Fiber</b> .....	<b>39</b>
Pre-terminated FACT ODF Fiber System Selection .....	39
Pre-terminated FACT ODF Fiber System Products .....	40
Pre-terminated FACT ODF Fiber System Cable Assemblies .....	41
Pre-terminated Stubbed Assemblies .....	44
<b>FiberGuide® Raceway Systems</b> .....	<b>46</b>
<b>Category 6A Systems</b> .....	<b>50</b>
<b>Powered Fiber Systems</b> .....	<b>52</b>
<b>DIN Rail Solutions for BMS Networks</b> .....	<b>55</b>
<b>Fiber Wall Boxes for Fiber Entrance Applications</b> .....	<b>58</b>
<b>2 Post Equipment Racks and Accessories</b> .....	<b>60</b>
<b>CommScope's imVision® Platform</b> .....	<b>62</b>
<b>Colocation Campus and Building Infrastructure</b> .....	<b>64</b>
Fiber Entrance and Meet-Me Room .....	66
High Fiber Count DC Interconnect .....	67
Campus Cabling .....	68
Building Cabling .....	69
IDF to Customer Cage (FACT ODF) .....	70
IDF to Customer Cage (19-in. Cabinet) .....	71
Campus Cabling for Wi-Fi and Security .....	72
<b>Customer Space Cabling Infrastructure</b> .....	<b>73</b>
Main Distribution Area (MDA) Fiber .....	75
Equipment Distribution Area (EDA) Fiber and Copper .....	76
FiberGuide Raceway Systems .....	78
<b>Reference Designs and Technical Information</b> .....	<b>79</b>



# Fiber Splice Systems

Fiber Entrance Cabinet (FEC)

FACT® Optical Distribution Frame (ODF)

Universal Mount Splice Cabinet (UMSC)

Flex Frame ODF and 19-in. Propel Panels

FOSC® 600 Series

19-in. Splice Solutions

Fiber Cables

Singlemode Patch Cord and Cable Management Products



The FEC is designed for applications requiring an interface for Intra Facility Cable (IFC) and Outside Plant (OSP) cable. The FEC provides storage and protection in addition to splicing.

The conventional splice drawer employed in the FEC provides service loop storage, which allows splicing away from the FEC. Cable access ports are located at the top, bottom, and both sides of the cabinet. Pre-formed rubber grommets are provided in each cable access port. The grommets have micro slits that can be easily cut out to match cable diameter. Each grommet can handle up to three cables.

The FEC range from CommScope comes in a number of different sizes, providing splicing, administration and storage for IFC and OSP cables. It offers a cost-effective, space-saving alternative to splicing on the fiber frame. Cabinets are designed for deployment in a building equipment area. Bend radius protection and discrete subunit routing paths ensure easy installation. Can deploy high count of stranded or ribbon fiber cables. Ultra high-density splice capacity is dependent on splice tray used.

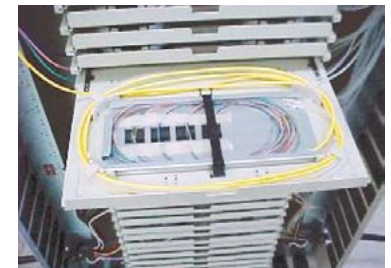

[Access the FEC Ordering Guide here.](#)



[Learn how to install FECs here.](#)

10,356 mass fusion splice capacity, wall-mounted splice cabinet, saves data center floor space

## Direct System Selection Index

FEC	FACT ODF	UMSC	Flex Frame ODF, 19-in. Propel Panels	FOSC 600	19-in. Splice Solutions	Singlemode Fiber Cables	Singlemode Patch Cord, Cable Mgmt Products	Pre-term 19-in. Fiber	Pre-term FACT ODF Fiber	FiberGuide	Copper Category 6A	Powered Fiber	DIN Rail Solutions	Fiber Wall Boxes	2 Post Equipment Racks	imVision®
-----	----------	------	--------------------------------------	----------	-------------------------	-------------------------	--	-----------------------	-------------------------	------------	--------------------	---------------	--------------------	------------------	------------------------	-----------

## Architecture System Selection Index

### Colocation Campus and Building Infrastructure

Fiber Entrance, Meet-Me Room	High Fiber Count DC Interconnect	Campus Cabling	Building Cabling	Campus Cabling for Wi-Fi and Security
------------------------------	----------------------------------	----------------	------------------	---------------------------------------

### Customer Space Cabling Infrastructure

MDA Fiber	EDA Fiber	EDA Copper	FiberGuide Raceway
-----------	-----------	------------	--------------------

### Reference Designs and Technical Information

MDA Cabinet	MDA Cross-connect 19-in.	MDA Cross-connect FACT ODF	IDF FACT	IDF 19-in.	FEC
-------------	--------------------------	----------------------------	----------	------------	-----



Select a product for more information.

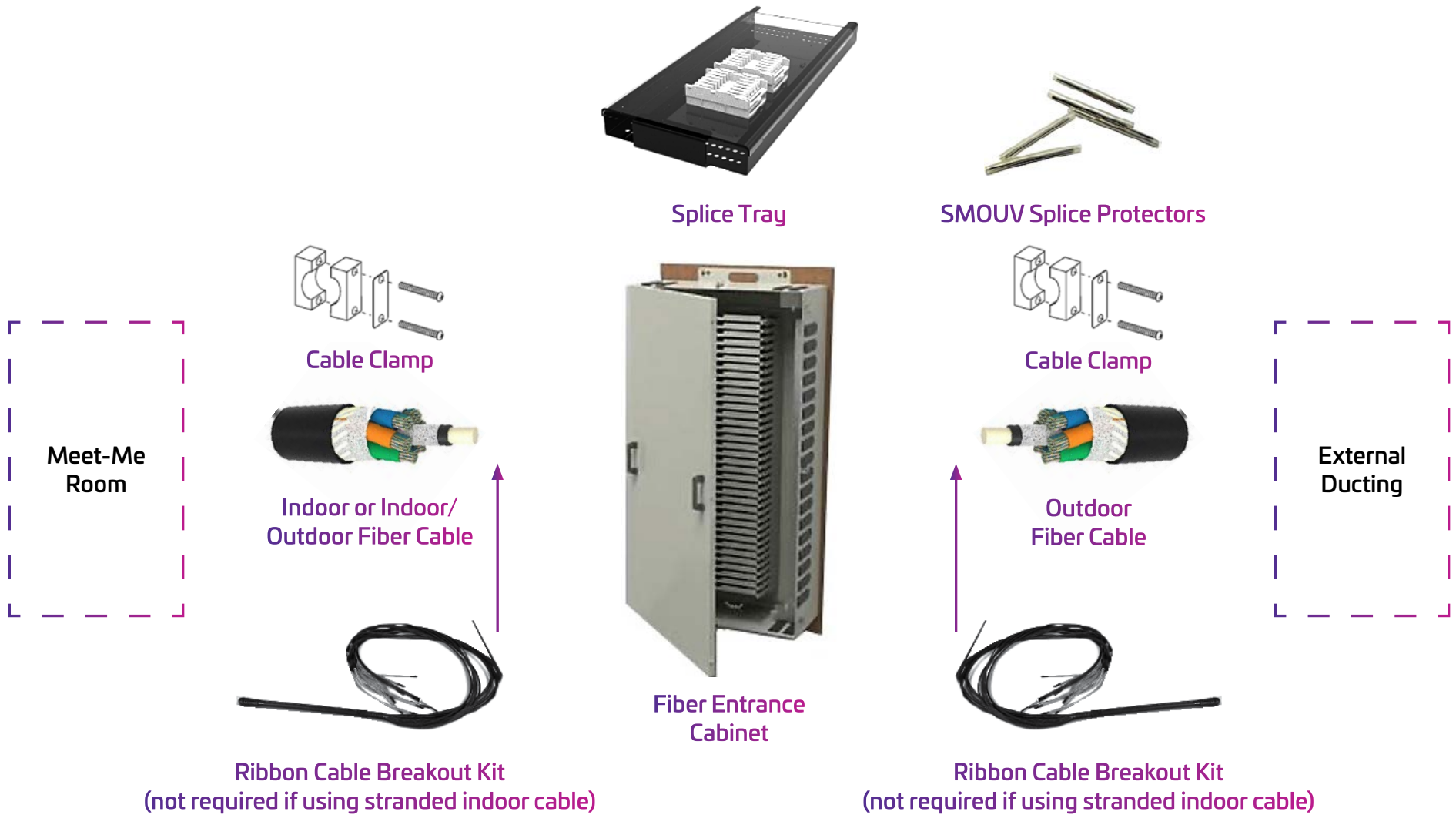

## Direct System Selection Index

FEC	FACT ODF	UMSC	Flex Frame ODF, 19-in. Propel Panels	FOSC 600	19-in. Splice Solutions	Singlemode Fiber Cables	Singlemode Patch Cord, Cable Mgmt Products	Pre-term 19-in. Fiber	Pre-term FACT ODF Fiber	FiberGuide	Copper Category 6A	Powered Fiber	DIN Rail Solutions	Fiber Wall Boxes	2 Post Equipment Racks	imVision®
-----	----------	------	--------------------------------------	----------	-------------------------	-------------------------	--	-----------------------	-------------------------	------------	--------------------	---------------	--------------------	------------------	------------------------	-----------

## Architecture System Selection Index

### Colocation Campus and Building Infrastructure

Fiber Entrance, Meet-Me Room	High Fiber Count DC Interconnect	Campus Cabling	Building Cabling	Campus Cabling for Wi-Fi and Security
------------------------------	----------------------------------	----------------	------------------	---------------------------------------

### Customer Space Cabling Infrastructure

MDA Fiber	EDA Fiber	EDA Copper	FiberGuide Raceway
-----------	-----------	------------	--------------------

### Reference Designs and Technical Information

MDA Cabinet	MDA Cross-connect 19-in.	MDA Cross-connect FACT ODF	IDF FACT	IDF 19-in.	FEC
-------------	--------------------------	----------------------------	----------	------------	-----



Review Fiber Entrance Cabinet (FEC) System Selection [here](#).

Wall-mounted Fiber Entrance Closure (FEC), Splice Trays Not Included	Dimensions	Total Number of Splices	Number of Drawers	Weight	Max Cable OD	Part Number
Fiber Optic Entrance Cabinet, 36 Drawers, Wall mounted	62 in. (1,574.8 mm) x 32 in. (812.8 mm) x 13 in. (330.2 mm)	10,368	36	160 lbs (72.6 kg)	0.30 in. – 1.2 in. (7.6 mm – 30.5 mm)	<a href="#">FEC-36</a>
Fiber Optic Entrance Cabinet, 24 Drawers, Wall mounted	45 in. (1,143 mm) x 32 in. (812.8 mm) x 13 in. (330.2 mm)	6,912	24	120 lbs (54.4 kg)	0.30 in. – 1.2 in. (7.6 mm – 30.5 mm)	<a href="#">FEC-24</a>
Fiber Optic Entrance Cabinet, 12 Drawers, Wall mounted	28 in. (711.2 mm) x 32 in. (812.8 mm) x 13 in. (330.2 mm)	3,456	12	80 lbs (36.3 kg)	0.30 in. – 1.2 in. (7.6 mm – 30.5 mm)	<a href="#">FEC-12</a>
Fiber Optic Entrance Cabinet, 6 Drawers, Wall mounted	19.48 in. (494.79 mm) x 32 in. (812.8 mm) x 13 in. (330.2 mm)	1,728	6	50 lbs (22.7 kg)	0.30 in. – 1.2 in. (7.6 mm – 30.5 mm)	<a href="#">FEC-6</a>

Splicing Accessories	Fiber Count	Breakout Length	Description Code	Part Number
Fiber Optic Splice Tray, 288 Ribbon Splice Capacity	288			<a href="#">FST-XD-MT</a>
Fiber Optic Splice Tray, 48 splice capacity, for stranded fiber use	48			<a href="#">FST-HS-48</a>
SMOUV Fiber Optic Splice Heat Shrink Protective Sleeve for 12 ribbons (Part Number = 1ea Sleeve. MOQ is 1,000 Sleeves)	12 ribbon fibers per sleeve		SMOUV-1120-R2/12-02	<a href="#">757849-000</a>
Fiber Optic Protective Splice Sleeve, 1 package, for stranded fiber use (Part Number = 50 Sleeves in Package. MOQ is 50 Packages)				<a href="#">FST-ACC001</a>
Breakout kit used across multiple applications (FEC, FLEX, OMX, SD cable counts 144F, 288F, 432F, 576F)	144/288/432/576	50 in	RIBCBOU-3/8-50-144/288/432/576	<a href="#">760244150</a>
Breakout kit used across multiple applications (FEC, FLEX, SD)	864/1152	50 in	RIBCBOU-3/8-50-864/1152	<a href="#">760244144</a>
Breakout kit used across multiple applications (FEC, FLEX, SD)	1728	75 in	RIBCBOU-3/8-75-1728	<a href="#">760244149</a>
Breakout kit used across multiple applications (FEC, FLEX)	3456	125 in	RIBCBOU-3/8-125-3456	<a href="#">760244147</a>

Cable Clamping Kits	Quantity			Part Number
IFC/OSP Cable clamp kit. Secures 3 cables with a maximum diameter each of 32 mm (1.25 in) to 38 mm (1.5 in), to a single entry point	6			<a href="#">OSP-CLPFEC-XL</a>
IFC/OSP Cable clamp kit. Secures 3 cables with a maximum diameter each of 32 mm (1.25 in) to 38 mm (1.5 in), to a single entry point	1			<a href="#">OSP-CLPFEC-XL-1</a>
IFC/OSP Cable clamp kit. Secures 3 cables with a maximum diameter each of 10 mm (0.4 in) to 30 mm (1.2 in), to a single entry point	3			<a href="#">OSP-CLPFEC-LG</a>
Soft IFC fiber optic cable clamp kit. Secures 1 cable with a maximum diameter of ø 20 mm (0.8 in) to 28 mm (1.1 in), to a single entry point	1			<a href="#">OSP-CLPSST-IFCL</a>
IFC/OSP Cable clamp kit. Secures 3 cables with a maximum diameter each of ø 5 mm (0.2 in) to 18 mm (0.7 in), to a single entry point	3			<a href="#">OSP-CLPFEC</a>
IFC/OSP Cable clamp kit. Secures 1 cable with a maximum diameter of ø 5 mm (0.2 in) to 18 mm (0.7 in), to a single entry point	1			<a href="#">OSP-CLPSST</a>
Soft IFC fiber optic cable clamp kit. Secures 1 cable with a maximum diameter of ø 5 mm (0.2 in) to 18 mm (0.7 in), to a single entry point	1			<a href="#">OSP-CLPSST-IFCS</a>

## Direct System Selection Index

FEC	FACT ODF	UMSC	Flex Frame ODF, 19-in. Propel Panels	FOSC 600	19-in. Splice Solutions	Singlemode Fiber Cables	Singlemode Patch Cord, Cable Mgmt Products	Pre-term 19-in. Fiber	Pre-term FACT ODF Fiber	FiberGuide	Copper Category 6A	Powered Fiber	DIN Rail Solutions	Fiber Wall Boxes	2 Post Equipment Racks	imVision®
-----	----------	------	--------------------------------------	----------	-------------------------	-------------------------	--	-----------------------	-------------------------	------------	--------------------	---------------	--------------------	------------------	------------------------	-----------

## Architecture System Selection Index

### Colocation Campus and Building Infrastructure

Fiber Entrance, Meet-Me Room	High Fiber Count DC Interconnect	Campus Cabling	Building Cabling	Campus Cabling for Wi-Fi and Security
------------------------------	----------------------------------	----------------	------------------	---------------------------------------

### Customer Space Cabling Infrastructure

MDA Fiber	EDA Fiber	EDA Copper	FiberGuide Raceway
-----------	-----------	------------	--------------------

### Reference Designs and Technical Information

MDA Cabinet	MDA Cross-connect 19-in.	MDA Cross-connect FACT ODF	IDF FACT	IDF 19-in.	FEC
-------------	--------------------------	----------------------------	----------	------------	-----



**Frame**

The FACT optical distribution frame solution begins with CommScope’s modular, lightweight FACT frame. Designed modularly with a small footprint, the fully front accessible FACT frame can be placed up against a wall, or back-to-back in a quad formation to maximize usable density. The frame provides dedicated spots for cable routing and color-coded fiber management, supporting up to 2,880 LC connections in a single frame.

The cross-connect FACT frame can be designed and easily installed with cable routing on either side of the frame, which includes backplate numbering—allowing for simple tracking of fibers whether you route from top to bottom or vice versa. One standard patch cord length can reach any position in a back-to-back configuration, reducing the number of cable lengths required.

The FACT frame accommodates not only FACT shelving, but standard 19-in. shelving as well, allowing you to increase your density while utilizing your current equipment. The FACT

frame is compatible with a range of accessories such as side panels, doors and cable attachment plates.

**Elements and chassis**

FACT elements may be deployed individually as a single-element chassis or grouped with other elements for higher density solutions. Each element measures 30.95 mm (1.22 in) tall, 30 percent less than the standard RU (44.45 mm/1.75 in). Each element supports two hinged trays that provide full front access to both sides of all connections and clear visibility of all ports. Five chassis types—patch-only, patch-splice, splice-splice, pre-cabled and NG4—enable customization of the FACT optical distribution frame to support virtually any application.

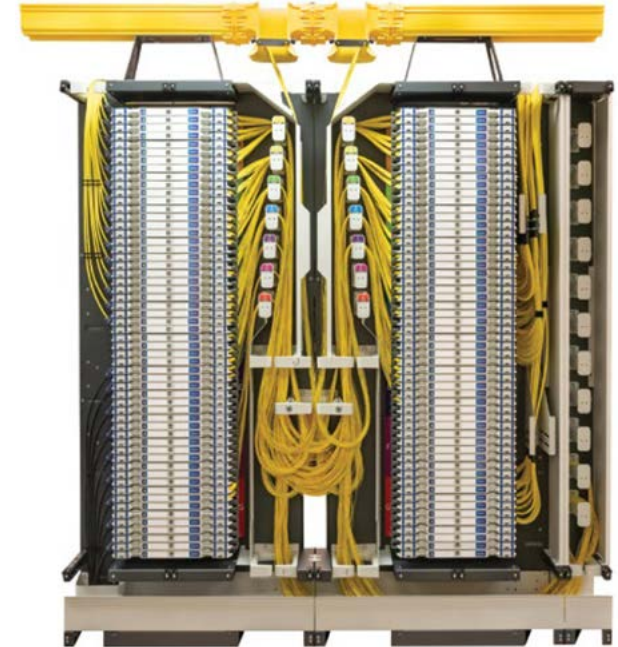

[Access the FACT Ordering Guide here.](#)



[Learn more about the FACT High Density ODF Solution here.](#)

**Direct System Selection Index**

FEC	FACT ODF	UMSC	Flex Frame ODF, 19-in. Propel Panels	FOSC 600	19-in. Splice Solutions	Singlemode Fiber Cables	Singlemode Patch Cord, Cable Mgmt Products	Pre-term 19-in. Fiber	Pre-term FACT ODF Fiber	FiberGuide	Copper Category 6A	Powered Fiber	DIN Rail Solutions	Fiber Wall Boxes	2 Post Equipment Racks	imVision®
-----	----------	------	--------------------------------------	----------	-------------------------	-------------------------	--	-----------------------	-------------------------	------------	--------------------	---------------	--------------------	------------------	------------------------	-----------

**Architecture System Selection Index**

**Colocation Campus and Building Infrastructure**

Fiber Entrance, Meet-Me Room	High Fiber Count DC Interconnect	Campus Cabling	Building Cabling	Campus Cabling for Wi-Fi and Security
------------------------------	----------------------------------	----------------	------------------	---------------------------------------

**Customer Space Cabling Infrastructure**

MDA Fiber	EDA Fiber	EDA Copper	FiberGuide Raceway
-----------	-----------	------------	--------------------

**Reference Designs and Technical Information**

MDA Cabinet	MDA Cross-connect 19-in.	MDA Cross-connect FACT ODF	IDF FACT	IDF 19-in.	FEC
-------------	--------------------------	----------------------------	----------	------------	-----





Select a product for more information.

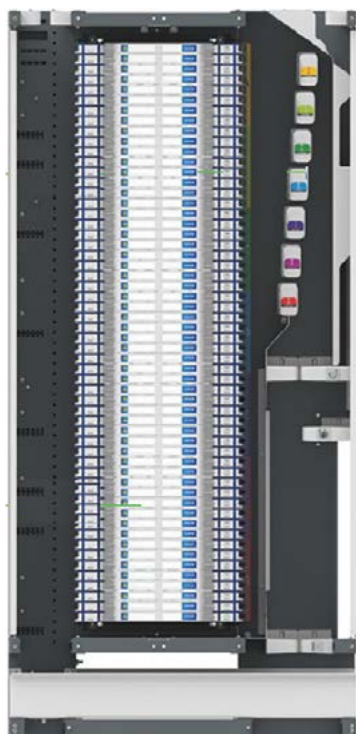

FACT Optical Distribution Frame



FACT Splice Chassis

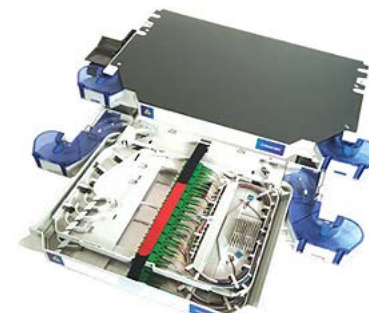

FACT Splice/Patch Chassis



Uniboot singlemode LC patchcords

## Direct System Selection Index

FEC	FACT ODF	UMSC	Flex Frame ODF, 19-in. Propel Panels	FOSC 600	19-in. Splice Solutions	Singlemode Fiber Cables	Singlemode Patch Cord, Cable Mgmt Products	Pre-term 19-in. Fiber	Pre-term FACT ODF Fiber	FiberGuide	Copper Category 6A	Powered Fiber	DIN Rail Solutions	Fiber Wall Boxes	2 Post Equipment Racks	imVision®
-----	----------	------	--------------------------------------	----------	-------------------------	-------------------------	--	-----------------------	-------------------------	------------	--------------------	---------------	--------------------	------------------	------------------------	-----------

## Architecture System Selection Index

### Colocation Campus and Building Infrastructure

Fiber Entrance, Meet-Me Room	High Fiber Count DC Interconnect	Campus Cabling	Building Cabling	Campus Cabling for Wi-Fi and Security
------------------------------	----------------------------------	----------------	------------------	---------------------------------------

### Customer Space Cabling Infrastructure

MDA Fiber	EDA Fiber	EDA Copper	FiberGuide Raceway
-----------	-----------	------------	--------------------

### Reference Designs and Technical Information

MDA Cabinet	MDA Cross-connect 19-in.	MDA Cross-connect FACT ODF	IDF FACT	IDF 19-in.	FEC
-------------	--------------------------	----------------------------	----------	------------	-----



Review FACT Optical Distribution Frame (ODF) Modular Design here.

Frames	Dimensions	Max. Termination Capacity	Catalog Number	Catalog Description
Cross-connect frame, patching on the left	2200 mm x 1050 mm x 300 mm (87 in. x 41 in. x 12 in)	2688 single LC or 1344 SC connections per frame	760243094	<a href="#">FACT-FRCLHP22</a>
Cross-connect frame, patching on the right	2200 mm x 1050 mm x 300 mm (87 in. x 41 in. x 12 in)	2688 single LC or 1344 SC connections per frame	760243095	<a href="#">FACT-FRCCRHP22</a>
Interconnect frame, patching on the right	2200 mm x 900 mm x 300 mm (87 in. x 35 in. x 12 in)	2880 single LC or 1440 SC connections per frame	760243096	<a href="#">FACT-FRICRHP22</a>
Path cord overlength management bay	2200 mm x 200 mm x 300 mm (87 in. x 8 in. x 12 in)	N/A	760243097	<a href="#">FACT-FROLB22</a>
Frame Accessories			Catalog Number	Catalog Description
Cross-connect door kit. Set of two doors with two door handles per door. The door handles are compatible with half cylinder locks according to DIN 18252 (EN 1303). Locks not included.			760243098	<a href="#">FACT-FRCCD22</a>
Cross-connect side panel kit (set of two panels)			760243099	<a href="#">FACT-FRCCP22</a>
Interconnect door kit. Set of two doors with two door handles per door. The door handles are compatible with half cylinder locks according to DIN 18252 (EN 1303). Locks not included.			760243100	<a href="#">FACT-FRICD22</a>
Patch cord overlength bay door. Set of one door with two door handles. The door handles are compatible with half cylinder locks according to DIN 18252 (EN 1303). Locks not included.			760243101	<a href="#">FACT-FROLBD22</a>
Fiber guide fixation kit			760243110	<a href="#">FACT-FRACCFG5</a>
Kit with two half cylinder locks according to DIN 18252 (EN 1303). Two lock kits are required for a frame door kit, only 1 lock kit required for OLB door kit.			760245341	<a href="#">FACT-FRACCDL2 (2-pack)</a>
FACT Cable Attachment Plates	Compatible with Frame		Catalog Number	Catalog Description
One cable attachment plate for frame side duct and one cable to flex conversion component set	FACT		760243108	<a href="#">FACT-FRACCCAPL</a>
One cable to flex conversion component set for cable attachment plate	FACT		760243111	<a href="#">FACT-FRACCCFT</a>
One fan out fixation plate for frame side duct and eight fan out fixation component sets	FACT		760243109	<a href="#">FACT-FRACCFOP1</a>
Eight fan out fixation component sets (for fan out fixation plate)	FACT		760243112	<a href="#">FACT-FRACCFOPK-8</a>
FACT Cable Termination Units	Element Type		Description Code	Part Number
FACT cable termination unit (CTU), kit for 6E FACT chassis, accommodates: 1 cable 2.5-14 mm or 2 cables 2.5-8.5 mm or 4 cables 2.5-5 mm or 1 flex tube OD 16 mm, only for use in. FACT frame	CTU		FACT-FRACCCTU6E	<a href="#">760243107</a>
FACT cable termination unit (CTU), kit for 4E FACT chassis, accommodates: 1 cable 2.5-14 mm or 2 cables 2.5-8.5 mm or 4 cables 2.5-5 mm or 1 flex tube OD 16 mm, only for use in. FACT frame	CTU		FACT-FRACCCTU4E	<a href="#">760243105</a>
FACT cable termination unit (CTU), kit for 3E FACT chassis, accommodates: 1 cable 2.5-14 mm or 2 cables 2.5-8.5 mm or 4 cables 2.5-5 mm or 1 flex tube OD 16 mm, only for use in. FACT frame	CTU		FACT-FRACCCTU3E	<a href="#">760243104</a>
FACT cable termination unit (CTU), kit for 2E FACT chassis, accommodates: 1 cable 2.5-14 mm or 2 cables 2.5-8.5 mm or 4 cables 2.5-5 mm or 1 flex tube OD 16 mm, only for use in. FACT frame	CTU		FACT-FRACCCTU2E	<a href="#">760243103</a>
FACT cable termination unit (CTU), kit for 1E FACT chassis, accommodates: 1 cable 2.5-14 mm or 2 cables 2.5-8.5 mm or 4 cables 2.5-5 mm or 1 flex tube OD 16 mm, only for use in. FACT frame	CTU		FACT-FRACCCTU1E	<a href="#">760243102</a>

**All frame kits include:**

- Wall and back-to-back connection kit
- Side-to-side connection kit
- Earthing kit
- Adjustable feet
- Intuitive installation instructions
- Color label kit for spool identification and intuitive patch cord routing
- Required hardware and fasteners
- Pre-installed position number identification strip for FACT-style and 19-in.-style

**All frame accessory kits include:**

- Intuitive installation instruction
- Required hardware and fasteners

Direct System Selection Index

FEC	FACT ODF	UMSC	Flex Frame ODF, 19-in. Propel Panels	FOSC 600	19-in. Splice Solutions	Singlemode Fiber Cables	Singlemode Patch Cord, Cable Mgmt Products	Pre-term 19-in. Fiber	Pre-term FACT ODF Fiber	FiberGuide	Copper Category 6A	Powered Fiber	DIN Rail Solutions	Fiber Wall Boxes	2 Post Equipment Racks	imVision®
-----	----------	------	--------------------------------------	----------	-------------------------	-------------------------	--	-----------------------	-------------------------	------------	--------------------	---------------	--------------------	------------------	------------------------	-----------

Architecture System Selection Index

Colocation Campus and Building Infrastructure

Fiber Entrance, Meet-Me Room	High Fiber Count DC Interconnect	Campus Cabling	Building Cabling	Campus Cabling for Wi-Fi and Security
------------------------------	----------------------------------	----------------	------------------	---------------------------------------

Customer Space Cabling Infrastructure

MDA Fiber	EDA Fiber	EDA Copper	FiberGuide Raceway
-----------	-----------	------------	--------------------

Reference Designs and Technical Information

MDA Cabinet	MDA Cross-connect 19-in.	MDA Cross-connect FACT ODF	IDF FACT	IDF 19-in.	FEC
-------------	--------------------------	----------------------------	----------	------------	-----



Review FACT Optical Distribution Frame (ODF) Modular Design here.

FACT Splice-Patch and Splice-Splice Elements	Element Type	Fiber Count	Fiber Type/Splice Protection	Description Code	Part Number
FACT Fiber Optic Patch/Splice Panel, gray, 6E high, 288-port, singlemode, loaded with LC/UPC adapters and C-grade pigtails, SMOUV splice tray type, left-hand patch	Splice-Patch	288	OS2/SMOUV	FACT-6ELHPL1S	<a href="#">760240562</a>
FACT Fiber Optic Patch/Splice Panel, gray, 6E high, 288-port, singlemode, loaded with LC/UPC adapters and C-grade pigtails, SMOUV splice tray type, right-hand patch	Splice-Patch	288	OS2/SMOUV	FACT-6ERHPL1S	<a href="#">760240694</a>
FACT Fiber Optic Patch/Splice Panel, gray, 4E high, 192-port, singlemode, loaded with LC/UPC adapters and C-grade pigtails, SMOUV splice tray type, left-hand patch	Splice-Patch	192	OS2/SMOUV	FACT-4ELHPL1S	<a href="#">760240013</a>
FACT Fiber Optic Patch/Splice Panel, gray, 4E high, 192-port, singlemode, loaded with LC/UPC adapters and C-grade pigtails, SMOUV splice tray type, right-hand patch	Splice-Patch	192	OS2/SMOUV	FACT-4ERHPL1S	<a href="#">760240055</a>
FACT Fiber Optic Patch/Splice Panel, gray, 3E high, 144-port, singlemode, loaded with LC/UPC adapters and C-grade pigtails, SMOUV splice tray type, left-hand patch	Splice-Patch	144	OS2/SMOUV	FACT-3ELHPL1S	<a href="#">760240007</a>
FACT Fiber Optic Patch/Splice Panel, gray, 3E high, 144-port, singlemode, loaded with LC/UPC adapters and C-grade pigtails, SMOUV splice tray type, right-hand patch	Splice-Patch	144	OS2/SMOUV	FACT-3ERHPL1S	<a href="#">760240027</a>
FACT Fiber Optic Patch/Splice Panel, gray, 2E high, 96-port, singlemode, loaded with LC/UPC adapters and C-grade pigtails, SMOUV splice tray type, left-hand patch	Splice-Patch	96	OS2/SMOUV	FACT-2ELHPL1S	<a href="#">760240001</a>
FACT Fiber Optic Patch/Splice Panel, gray, 2E high, 96-port, singlemode, loaded with LC/UPC adapters and C-grade pigtails, SMOUV splice tray type, right-hand patch	Splice-Patch	96	OS2/SMOUV	FACT-2ERHPL1S	<a href="#">760240020</a>
FACT Fiber Optic Patch/Splice Panel, gray, 1E high, 48-port, singlemode, loaded with LC/UPC adapters and C-grade pigtails, SMOUV splice tray type, left-hand patch	Splice-Patch	48	OS2/SMOUV	FACT-1ELHPL1S	<a href="#">760240450</a>
FACT Fiber Optic Patch/Splice Panel, gray, 1E high, 48-port, singlemode, loaded with LC/UPC adapters and C-grade pigtails, SMOUV splice tray type, right-hand patch	Splice-Patch	48	OS2/SMOUV	FACT-1ERHPL1S	<a href="#">760240585</a>

Note: FACT elements are also available with APC finish. Check with your local CommScope Systems Engineering Contact

Direct System Selection Index

FEC	FACT ODF	UMSC	Flex Frame ODF, 19-in. Propel Panels	FOSC 600	19-in. Splice Solutions	Singlemode Fiber Cables	Singlemode Patch Cord, Cable Mgmt Products	Pre-term 19-in. Fiber	Pre-term FACT ODF Fiber	FiberGuide	Copper Category 6A	Powered Fiber	DIN Rail Solutions	Fiber Wall Boxes	2 Post Equipment Racks	imVision®
-----	----------	------	--------------------------------------	----------	-------------------------	-------------------------	--	-----------------------	-------------------------	------------	--------------------	---------------	--------------------	------------------	------------------------	-----------

Architecture System Selection Index

Colocation Campus and Building Infrastructure

Fiber Entrance, Meet-Me Room	High Fiber Count DC Interconnect	Campus Cabling	Building Cabling	Campus Cabling for Wi-Fi and Security
------------------------------	----------------------------------	----------------	------------------	---------------------------------------

Customer Space Cabling Infrastructure

MDA Fiber	EDA Fiber	EDA Copper	FiberGuide Raceway
-----------	-----------	------------	--------------------

Reference Designs and Technical Information

MDA Cabinet	MDA Cross-connect 19-in.	MDA Cross-connect FACT ODF	IDF FACT	IDF 19-in.	FEC
-------------	--------------------------	----------------------------	----------	------------	-----



Review FACT Optical Distribution Frame (ODF) Modular Design here.

FACT Splice Chassis	Number of Trays Per FACT Chassis				
The FACT splice chassis is a multipurpose splice shelf featuring 72 SMOUV splices per FACT element. In combination with the FACT-ACCCTU accessories, the FACT splice chassis supports multiple splice applications, including: <ul style="list-style-type: none"> <li>• Outdoor-to-indoor loose-tube cable</li> <li>• Loose-tube cable to pigtails (single aramid yarn termination)</li> <li>• Loose-tube cable to breakout or intra-facility (IFC) cable</li> <li>• Pigtail to pigtail (single aramid yarn termination)</li> </ul>		<b>A04</b>	<b>S04</b>	<b>A12</b>	<b>S12</b>
	<b>1E</b>	12	12	8	6
	<b>2E</b>	24	24	16	12
	<b>3E</b>	36	36	24	18
	<b>4E</b>	48	48	32	24
FACT Splice-Patch and Splice-Splice Elements	Element Type	Fiber Count	Fiber Type/Splice Protection	Description Code	Part Number
FACT Fiber Optic Splice Panel, gray, 4E high, loaded with 24 trays for holding up to 12 SMOUV type splices per tray	Splice - Splice	288	OS2/SMOUV	FACT-4ESPLS12	<a href="#">760239970</a>
FACT Fiber Optic Splice Panel, gray, 2E high, loaded with 12 trays for holding up to 12 SMOUV type splices per tray	Splice - Splice	144	OS2/SMOUV	FACT-2ESPLS12	<a href="#">760239963</a>
FACT Fiber Optic Splice Panel, gray, 1E high, loaded with 6 trays for holding up to 12 SMOUV type splices per tray	Splice - Splice	72	OS2/SMOUV	FACT-1ESPLS12	<a href="#">760239959</a>

Direct System Selection Index

FEC	FACT ODF	UMSC	Flex Frame ODF, 19-in. Propel Panels	FOSC 600	19-in. Splice Solutions	Singlemode Fiber Cables	Singlemode Patch Cord, Cable Mgmt Products	Pre-term 19-in. Fiber	Pre-term FACT ODF Fiber	FiberGuide	Copper Category 6A	Powered Fiber	DIN Rail Solutions	Fiber Wall Boxes	2 Post Equipment Racks	imVision®
-----	----------	------	--------------------------------------	----------	-------------------------	-------------------------	--	-----------------------	-------------------------	------------	--------------------	---------------	--------------------	------------------	------------------------	-----------

Architecture System Selection Index

Colocation Campus and Building Infrastructure

Fiber Entrance, Meet-Me Room	High Fiber Count DC Interconnect	Campus Cabling	Building Cabling	Campus Cabling for Wi-Fi and Security
------------------------------	----------------------------------	----------------	------------------	---------------------------------------

Customer Space Cabling Infrastructure

MDA Fiber	EDA Fiber	EDA Copper	FiberGuide Raceway
-----------	-----------	------------	--------------------

Reference Designs and Technical Information

MDA Cabinet	MDA Cross-connect 19-in.	MDA Cross-connect FACT ODF	IDF FACT	IDF 19-in.	FEC
-------------	--------------------------	----------------------------	----------	------------	-----



Designed for flexibility and user friendliness, the Universal Mounted Splice Cabinet has the ability to mount in a 19-in. or 23-in. two- or four-post rack. It can also be mounted on the wall. This high density solution allows for up to 6912 splices in the 24-tray cabinet size, and 3456 splices in the 12-tray cabinet size, which are easily accessible due to the dedicated mesh tubing routing. The Universal Mounted Splice Cabinet's unique design includes over 6 ft (1.8 m) of slack to allow up to three splicers to be working side-by-side at the same time.



## Direct System Selection Index

FEC	FACT ODF	UMSC	Flex Frame ODF, 19-in. Propel Panels	FOSC 600	19-in. Splice Solutions	Singlemode Fiber Cables	Singlemode Patch Cord, Cable Mgmt Products	Pre-term 19-in. Fiber	Pre-term FACT ODF Fiber	FiberGuide	Copper Category 6A	Powered Fiber	DIN Rail Solutions	Fiber Wall Boxes	2 Post Equipment Racks	imVision®
-----	----------	------	--------------------------------------	----------	-------------------------	-------------------------	--	-----------------------	-------------------------	------------	--------------------	---------------	--------------------	------------------	------------------------	-----------

## Architecture System Selection Index

### Colocation Campus and Building Infrastructure

Fiber Entrance, Meet-Me Room	High Fiber Count DC Interconnect	Campus Cabling	Building Cabling	Campus Cabling for Wi-Fi and Security
------------------------------	----------------------------------	----------------	------------------	---------------------------------------

### Customer Space Cabling Infrastructure

MDA Fiber	EDA Fiber	EDA Copper	FiberGuide Raceway
-----------	-----------	------------	--------------------

### Reference Designs and Technical Information

MDA Cabinet	MDA Cross-connect 19-in.	MDA Cross-connect FACT ODF	IDF FACT	IDF 19-in.	FEC
-------------	--------------------------	----------------------------	----------	------------	-----



Select a product for more information.

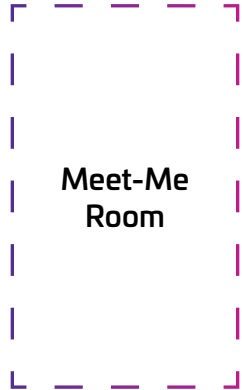

Indoor or Indoor/  
Outdoor Fiber Cable



Ribbon Cable Breakout Kit  
(not required if using stranded indoor cable)



Splice Tray

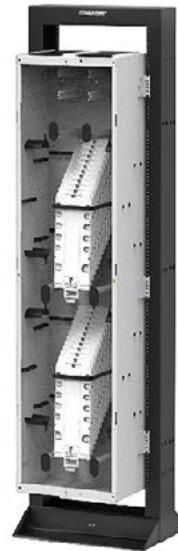

Universal Mount  
Splice Cabinet



SMOUV Splice Protectors



Outdoor Rollable  
Ribbon Fiber Cable



Ribbon Cable Breakout Kit

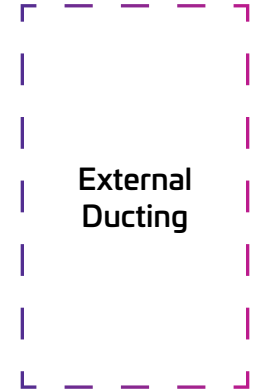

## Direct System Selection Index

FEC	FACT ODF	UMSC	Flex Frame ODF, 19-in. Propel Panels	FOSC 600	19-in. Splice Solutions	Singlemode Fiber Cables	Singlemode Patch Cord, Cable Mgmt Products	Pre-term 19-in. Fiber	Pre-term FACT ODF Fiber	FiberGuide	Copper Category 6A	Powered Fiber	DIN Rail Solutions	Fiber Wall Boxes	2 Post Equipment Racks	imVision®
-----	----------	------	--------------------------------------	----------	-------------------------	-------------------------	--	-----------------------	-------------------------	------------	--------------------	---------------	--------------------	------------------	------------------------	-----------

## Architecture System Selection Index

### Colocation Campus and Building Infrastructure

Fiber Entrance, Meet-Me Room	High Fiber Count DC Interconnect	Campus Cabling	Building Cabling	Campus Cabling for Wi-Fi and Security
------------------------------	----------------------------------	----------------	------------------	---------------------------------------

### Customer Space Cabling Infrastructure

MDA Fiber	EDA Fiber	EDA Copper	FiberGuide Raceway
-----------	-----------	------------	--------------------

### Reference Designs and Technical Information

MDA Cabinet	MDA Cross-connect 19-in.	MDA Cross-connect FACT ODF	IDF FACT	IDF 19-in.	FEC
-------------	--------------------------	----------------------------	----------	------------	-----



Review Universal Mount Splice Cabinet (UMSC) System Selection [here](#).

Universal Mount Splice Cabinet	Fiber Count	Dimensions	Weight	Description Code	Part Number
Universal Mount Splice Cabinet with up to 3456 fiber splices capacity (Rollable ribbon cables), 12 trays, exit up, gray	3,456	42.3 in. (1074 cm) x 17.84 in. (45.3 cm) x 11.54 in. (29.3 cm)	32 lbs. (14.5 kg)	ODF-SPLCAB-12	<a href="#">760248104</a>
Universal Mount Splice Cabinet with up to 6912 fiber splices capacity (Rollable ribbon cables), 24 trays, exit up, gray	6,912	68.5 in. (174 cm) x 17.84 in. (45.3 cm) x 11.54 in. (29.3 cm)	52 lbs. (23.6 kg)	ODF-SPLCAB-24	<a href="#">760245548</a>
Splicing Accessories	Fiber Count	Breakout Length	Description Code	Part Number	
FOST splice tray, 288f Rollable ribbon fiber splicing per tray	288	N/A	FOST-ACC-D-TRAY-RR-288-KIT	<a href="#">760243050</a>	
Breakout kit used across multiple applications (FEC, FLEX, OMX, SD cable counts 144F, 288F, 432F, 576F)	144/288/432/576	50 in	RIBCBOU-3/8-50-144/288/432/576	<a href="#">760244150</a>	
Breakout kit used across multiple applications (FEC, FLEX, SD)	864/1152	50 in	RIBCBOU-3/8-50-864/1152	<a href="#">760244144</a>	
Breakout kit used across multiple applications (FEC, FLEX, SD)	1728	75 in	RIBCBOU-3/8-75-1728	<a href="#">760244149</a>	
Breakout kit used across multiple applications (FEC, FLEX)	3456	125 in	RIBCBOU-3/8-125-3456	<a href="#">760244147</a>	
Accessories	Description Code	Part Number			
Equipment Rack, 2-Post, 6 in. (152 mm) Channel x 7 ft (2134 mm) H - 19 in. (482.6 mm) Alu (45U) 12-24 Tapped Rails, Black	RK6-45A	<a href="#">760082495</a>			
19-in. rack mount brack for Universal Mount Splice Cabinet, 1 kit per cabinet	ODF-ACC-BRK-19	<a href="#">760245549</a>			
Raised Floor Mounting Kit, 5/8-in.		<a href="#">FDF-ACC146</a>			
SMOUV Fiber Optic Splice Heat Shrink Protective Sleeve for 12 ribbons (1000 sleeves per MID)	SMOUV-1120-R2/12-02	<a href="#">757849-000</a>			
ODF-ACC-BRK-WM, Wall Mount brack for Universal Mount Splice Cabinet, 1 kit per cabinet	ODF-ACC-BRK-WM	<a href="#">760245551</a>			

## Direct System Selection Index

FEC	FACT ODF	UMSC	Flex Frame ODF, 19-in. Propel Panels	FOSC 600	19-in. Splice Solutions	Singlemode Fiber Cables	Singlemode Patch Cord, Cable Mgmt Products	Pre-term 19-in. Fiber	Pre-term FACT ODF Fiber	FiberGuide	Copper Category 6A	Powered Fiber	DIN Rail Solutions	Fiber Wall Boxes	2 Post Equipment Racks	imVision®
-----	----------	------	--------------------------------------	----------	-------------------------	-------------------------	--	-----------------------	-------------------------	------------	--------------------	---------------	--------------------	------------------	------------------------	-----------

## Architecture System Selection Index

### Colocation Campus and Building Infrastructure

Fiber Entrance, Meet-Me Room	High Fiber Count DC Interconnect	Campus Cabling	Building Cabling	Campus Cabling for Wi-Fi and Security
------------------------------	----------------------------------	----------------	------------------	---------------------------------------

### Customer Space Cabling Infrastructure

MDA Fiber	EDA Fiber	EDA Copper	FiberGuide Raceway
-----------	-----------	------------	--------------------

### Reference Designs and Technical Information

MDA Cabinet	MDA Cross-connect 19-in.	MDA Cross-connect FACT ODF	IDF FACT	IDF 19-in.	FEC
-------------	--------------------------	----------------------------	----------	------------	-----



- Accepts up to nine 4RU chassis
- Enables interconnect and/or cross-connect applications
- Integral slack storage reduces jumper congestion
- An integrated lower trough system with passthrough simplifies cable routing in a frame lineup
- On-frame splicing eliminates the need to access the rear of each panel to perform splicing, thereby reducing the risk of damage to the panel's internal components
- Integrated left-side cable entry ports on splice cabinet standardizes the length of split convoluted tubing needed to provide additional protection of the mesh sleeve-enclosed 24-fiber ribbon bundles
- Slack storage capacity of at least 10 ft (3.05 m) of mesh-enclosed ribbon slack per 24-fiber ribbon bundle

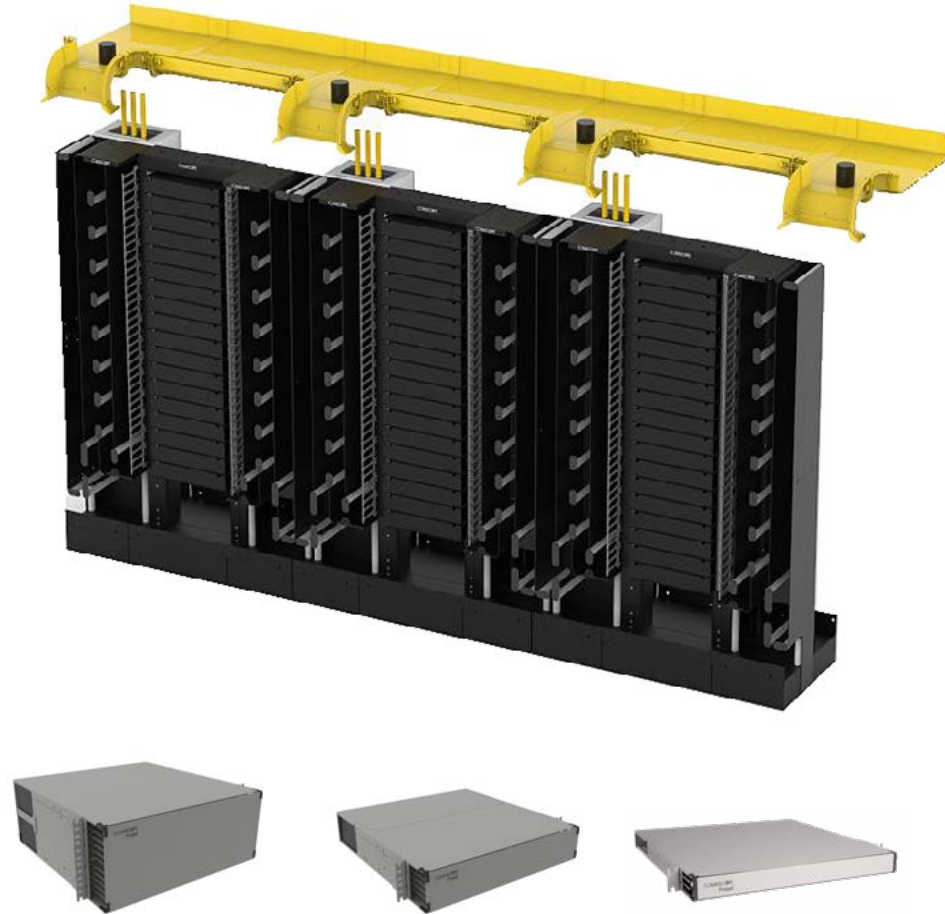

Propel fiber solutions are designed for today's more crowded and demanding environments. Propel supports 72 duplex LC ports or 72 MPO ports per RU. Propel modules, adapter packs and cassettes are 24 fiber solutions.

[Access the Flex Frame User Manual here.](#)

## Direct System Selection Index

FEC	FACT ODF	UMSC	Flex Frame ODF, 19-in. Propel Panels	FOSC 600	19-in. Splice Solutions	Singlemode Fiber Cables	Singlemode Patch Cord, Cable Mgmt Products	Pre-term 19-in. Fiber	Pre-term FACT ODF Fiber	FiberGuide	Copper Category 6A	Powered Fiber	DIN Rail Solutions	Fiber Wall Boxes	2 Post Equipment Racks	imVision®
-----	----------	------	--------------------------------------	----------	-------------------------	-------------------------	--	-----------------------	-------------------------	------------	--------------------	---------------	--------------------	------------------	------------------------	-----------

## Architecture System Selection Index

### Colocation Campus and Building Infrastructure

Fiber Entrance, Meet-Me Room	High Fiber Count DC Interconnect	Campus Cabling	Building Cabling	Campus Cabling for Wi-Fi and Security
------------------------------	----------------------------------	----------------	------------------	---------------------------------------

### Customer Space Cabling Infrastructure

MDA Fiber	EDA Fiber	EDA Copper	FiberGuide Raceway
-----------	-----------	------------	--------------------

### Reference Designs and Technical Information

MDA Cabinet	MDA Cross-connect 19-in.	MDA Cross-connect FACT ODF	IDF FACT	IDF 19-in.	FEC
-------------	--------------------------	----------------------------	----------	------------	-----





Select a product for more information.

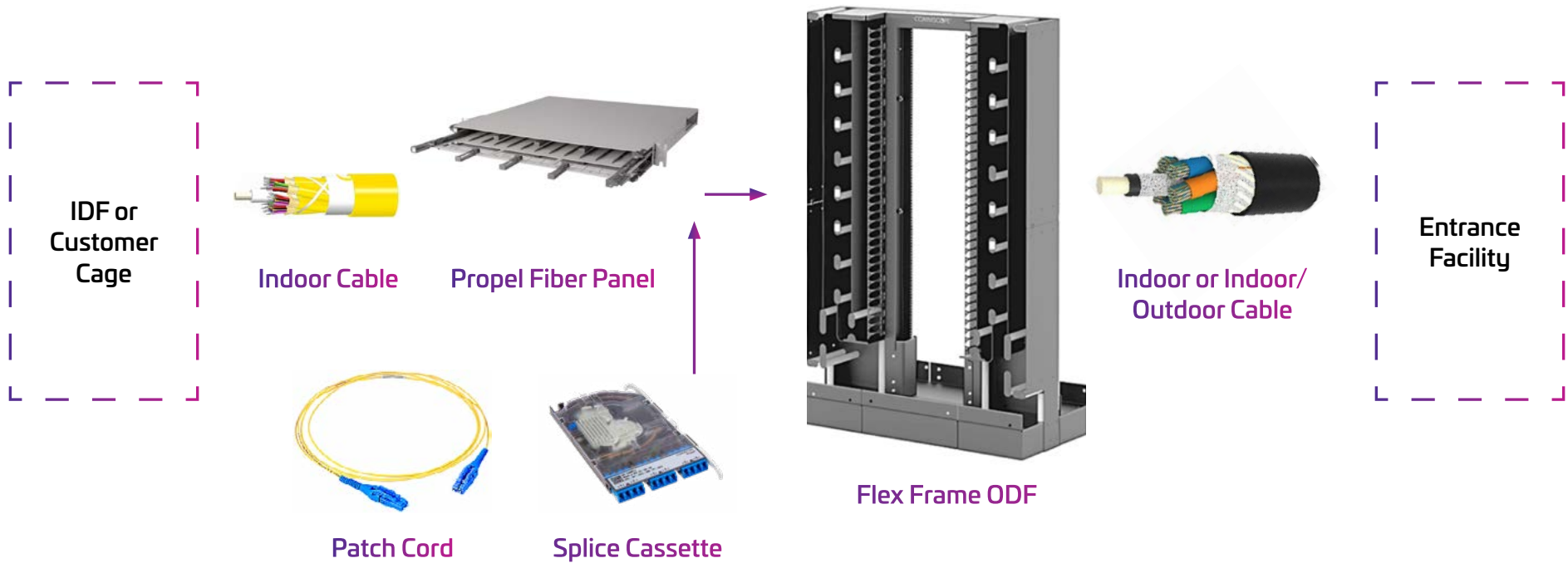

## Direct System Selection Index

FEC	FACT ODF	UMSC	Flex Frame ODF, 19-in. Propel Panels	FOSC 600	19-in. Splice Solutions	Singlemode Fiber Cables	Singlemode Patch Cord, Cable Mgmt Products	Pre-term 19-in. Fiber	Pre-term FACT ODF Fiber	FiberGuide	Copper Category 6A	Powered Fiber	DIN Rail Solutions	Fiber Wall Boxes	2 Post Equipment Racks	imVision®
-----	----------	------	--------------------------------------	----------	-------------------------	-------------------------	--	-----------------------	-------------------------	------------	--------------------	---------------	--------------------	------------------	------------------------	-----------

## Architecture System Selection Index

### Colocation Campus and Building Infrastructure

Fiber Entrance, Meet-Me Room	High Fiber Count DC Interconnect	Campus Cabling	Building Cabling	Campus Cabling for Wi-Fi and Security
------------------------------	----------------------------------	----------------	------------------	---------------------------------------

### Customer Space Cabling Infrastructure

MDA Fiber	EDA Fiber	EDA Copper	FiberGuide Raceway
-----------	-----------	------------	--------------------

### Reference Designs and Technical Information

MDA Cabinet	MDA Cross-connect 19-in.	MDA Cross-connect FACT ODF	IDF FACT	IDF 19-in.	FEC
-------------	--------------------------	----------------------------	----------	------------	-----



## Review Flex Frame System Selection here.

Flex Frame ODF	Dimensions		Weight	Description Code	Part Number
Rack with cable managers, 19" standard mouting, 36 RU of open rack space	H: 2.134 m   84 in. W: 1.3391 m   52.72 in. D: 1.3391 m   52.72 in.		181.437 kg   400 kg	ODF-FF19CM-36	<a href="#">760242401</a>
Propel Chassis	HU	Max Number of LC Connectors	Number of 12 Fiber Propel Splice Cassettes	Description Code	Part Number
Propel 4RU sliding tray fiber panel, accepts Propel ULL modules or adapter packs, providing up to 288 duplex LC ports, 288 MPO ports or 576 SN ports (1152f)	4	576	48	PPL-4U	<a href="#">760252004</a>
Propel 2RU sliding tray fiber panel, accepts Propel ULL modules or adapter packs, providing up to 144 duplex LC ports, 144 MPO ports or 288 SN ports (576f)	2	288	24	PPL-2U	<a href="#">760252003</a>
Propel 1RU sliding tray fiber panel, accepts Propel ULL modules or adapter packs, providing up to 72 duplex LC ports, 72 MPO ports or 144 SN ports (288f)	1	144	12	PPL-1U	<a href="#">760252002</a>
Splice Cassettes	Fiber Type	Pigtail Fiber Type	Polarity Method	Description Code	Part Number
Propel Singlemode Splice Cassette, 24LC/UPC with internal shutters, OS2 ribbon fiber pigtail, Method B Enhanced ULL	OS2	Rollable Ribbon	Method B Enhanced	PPL-SP-24LC-SM-RPT-BEU	<a href="#">760255056</a>
Propel Singlemode Splice Cassette, 24LC/UPC with internal shutters, OS2 250µm single fiber pigtails, Method B Enhanced ULL	OS2	Ribbon	Method B Enhanced	PPL-SP-24LC-SM-PT-BEU	<a href="#">760255053</a>
Propel Singlemode Splice Cassette, 24LC/UPC with internal shutters, OS2 250µm single fiber pigtails, Method A Straight ULL	OS2	Stranded	Method A ( Pairs Straight)	PPL-SP-24LC-SM-PT-ASU	<a href="#">760255081</a>
Propel Singlemode Splice Cassette, 12LC/UPC with internal shutters, 250 µm OS2 single fiber pigtails, Method B Enhanced ULL	OS2	Stranded	Method B Enhanced	PPL-SP-12LC-SM-PT-BEU	<a href="#">760255043</a>
Propel Singlemode Splice Cassette, 12LC/UPC with internal shutters, 250 µm OS2 single fiber pigtails, Method A Straight ULL	OS2	Ribbon	Method A	PPL-SP-12LC-SM-PT-AS	<a href="#">760255076</a>
Propel Multimode Splice Cassette, 24LC/UPC with internal shutters, OM4 250µm single fiber pigtails, Method B Enhanced ULL	OM4	Ribbon	Method B Enhanced	PPL-SP-24LC-OM4-PT-BEU	<a href="#">760255054</a>
Propel Multimode Splice Cassette, 24LC/UPC with internal shutters, OM4 ribbon fiber pigtail, Method B Enhanced ULL	OM4	Rollable Ribbon	Method B Enhanced	PPL-SP-24LC-OM4-RPT-BEU	<a href="#">760255057</a>
Accessories				Description Code	Part Number
Raised Floor Mounting Kit, 5/8-in				N/A	<a href="#">FDF-ACC146</a>
Concrete Floor Mounting Kit, 5/8-in				N/A	<a href="#">RINST-FLR</a>
Small universal blocking kit, for use with ribbon fiber splice cassettes				BK-FP-SML	<a href="#">760238380</a>

## Direct System Selection Index

FEC	FACT ODF	UMSC	Flex Frame ODF, 19-in. Propel Panels	FOSC 600	19-in. Splice Solutions	Singlemode Fiber Cables	Singlemode Patch Cord, Cable Mgmt Products	Pre-term 19-in. Fiber	Pre-term FACT ODF Fiber	FiberGuide	Copper Category 6A	Powered Fiber	DIN Rail Solutions	Fiber Wall Boxes	2 Post Equipment Racks	imVision®
-----	----------	------	--------------------------------------	----------	-------------------------	-------------------------	--	-----------------------	-------------------------	------------	--------------------	---------------	--------------------	------------------	------------------------	-----------

## Architecture System Selection Index

### Colocation Campus and Building Infrastructure

Fiber Entrance, Meet-Me Room	High Fiber Count DC Interconnect	Campus Cabling	Building Cabling	Campus Cabling for Wi-Fi and Security
------------------------------	----------------------------------	----------------	------------------	---------------------------------------

### Customer Space Cabling Infrastructure

MDA Fiber	EDA Fiber	EDA Copper	FiberGuide Raceway
-----------	-----------	------------	--------------------

### Reference Designs and Technical Information

MDA Cabinet	MDA Cross-connect 19-in.	MDA Cross-connect FACT ODF	IDF FACT	IDF 19-in.	FEC
-------------	--------------------------	----------------------------	----------	------------	-----



With the FOSC 600 Series, CommScope offers customers high-capacity fiber splicing solutions built on the industry-leading design of the FOSC series and our unique engineering expertise in delivering both high density and ease of use.

The FOSC 600 Series can be used in a variety of trunk and feeder applications for splicing a wide range of fiber cable types and sizes, housing of connectorized distribution and demarcation points and deployment of optical passives.

The sealing system of the FOSC 600 builds on the proven reliability of the FOSC 450 series and features the versatile and popular gel sealing technology for termination cables and a unique latching system for quick closure opening and closing without any special tools required.

The FOSC 600D Series can be deployed anywhere in the outside plant for a multitude of functions including the splicing of almost any cable type, up to 1.4 in.(3.56 cm) diameter and 1,728 fiber splice capacity. It's used to house the connectorized distribution and demarcation points and the deployment of optical passives.

Using the same closure, the FOSC 600D-XL series is like the 600D except it has a larger tray tower

enabling up to 12 single fiber trays or six ribbon fiber trays with up to 3,456 fiber splice capacity.

**Features and benefits**

- Up to 1,728 single fibers or 3,456 ribbon fibers
- Up to 12 single fiber trays or six ribbon fiber trays
- Up to 16 separate cable ports
- Cables up to 1.4 in.(3.56 cm) diameter
- Compact size designed for easy field stacking
- Butt or inline splice closure, field configurable
- All internal parts can be removed for easy re-configuration
- Hinging trays with controlled access to splices and slack storage
- Superior fiber management
- Storage basket included
- Wall-mount bracket included

- Slack ribbon storage on the same tray as mass fusion splices
- A range of accessories for a variety of outside plant needs



Learn about dressing ribbon fiber into FOSC and splice tray here.



Shown with 12 single height trays

**Direct System Selection Index**

FEC	FACT ODF	UMSC	Flex Frame ODF, 19-in. Propel Panels	FOSC 600	19-in. Splice Solutions	Singlemode Fiber Cables	Singlemode Patch Cord, Cable Mgmt Products	Pre-term 19-in. Fiber	Pre-term FACT ODF Fiber	FiberGuide	Copper Category 6A	Powered Fiber	DIN Rail Solutions	Fiber Wall Boxes	2 Post Equipment Racks	imVision®
-----	----------	------	--------------------------------------	----------	-------------------------	-------------------------	--	-----------------------	-------------------------	------------	--------------------	---------------	--------------------	------------------	------------------------	-----------

**Architecture System Selection Index**

**Colocation Campus and Building Infrastructure**

Fiber Entrance, Meet-Me Room	High Fiber Count DC Interconnect	Campus Cabling	Building Cabling	Campus Cabling for Wi-Fi and Security
------------------------------	----------------------------------	----------------	------------------	---------------------------------------

**Customer Space Cabling Infrastructure**

MDA Fiber	EDA Fiber	EDA Copper	FiberGuide Raceway
-----------	-----------	------------	--------------------

**Reference Designs and Technical Information**

MDA Cabinet	MDA Cross-connect 19-in.	MDA Cross-connect FACT ODF	IDF FACT	IDF 19-in.	FEC
-------------	--------------------------	----------------------------	----------	------------	-----



Select a product for more information.



Rollable Ribbon Fiber Cable



FOSC Fiber Splice Closure



Rollable Ribbon Fiber Cable



FOSC600D-XL Fiber Splice Closure with Splice Trays	Dimensions	Total Number of Splices	Number of Splice Trays Included	Number of Splices Per Tray	Description Code	Part Number
3,456 fiber splice capacity. FOSC 600D-XL Fiber Optic Splice Closure Kit with 12 x FOSC D-48 standard size splice trays installed, each capable of up to 288 splices of 12 fiber “rollable ribbon” or “spider ribbon” fiber. Kit also includes 2 x 3-port FOSC 600 gel blocks, XL version slack storage basket, 2 x ground feedthrough lugs, flash test valve, and associated closure hardware and components.	10 in. (25.4 cm) x 10.8 in. (27.4 cm) x 32.6 in. (82.8 cm)	3,456	12	288	FOSC600-D6B-24-12-X2VXL	379484-000
1,728 fiber splice capacity. FOSC 600D-XL Fiber Optic Splice Closure Kit with 6 x FOSC D size Ribbon splice trays installed, each capable of up to 288 splices of ribbon 12 fiber. Kit also includes 2 x 3-port FOSC 600 gel blocks, XL version slack storage basket, 2 x ground feedthrough lugs, flash test valve, and associated closure hardware and components.	10 in. (25.4 cm) x 10.8 in. (27.4 cm) x 32.6 in. (82.8 cm)	1,728	6	288	FOSC600-D6B-R2-6-X2VXL	233947-000
864 fiber splice capacity. FOSC 600D-XL Fiber Optic Splice Closure Kit with 6 x FOSC D size Ribbon splice trays installed, each capable of up to 288 splices of ribbon 12 fiber. Kit also includes 2 x 4-port FOSC 600 gel blocks, XL version slack storage basket, 2 x ground feedthrough lugs, flash test valve, and associated closure hardware and components.	10 in. (25.4 cm) x 10.8 in. (27.4 cm) x 32.6 in. (82.8 cm)	864	6	288	FOSC600-D8B-R2-6-X2VXL	371599-000

CommScope offers a range of fiber splice enclosures to manage 160+ fibers. Please contact your partner or CommScope TAC for more details.

Direct System Selection Index

FEC	FACT ODF	UMSC	Flex Frame ODF, 19-in. Propel Panels	FOSC 600	19-in. Splice Solutions	Singlemode Fiber Cables	Singlemode Patch Cord, Cable Mgmt Products	Pre-term 19-in. Fiber	Pre-term FACT ODF Fiber	FiberGuide	Copper Category 6A	Powered Fiber	DIN Rail Solutions	Fiber Wall Boxes	2 Post Equipment Racks	imVision®
-----	----------	------	--------------------------------------	----------	-------------------------	-------------------------	--	-----------------------	-------------------------	------------	--------------------	---------------	--------------------	------------------	------------------------	-----------

Architecture System Selection Index

Colocation Campus and Building Infrastructure

Fiber Entrance, Meet-Me Room	High Fiber Count DC Interconnect	Campus Cabling	Building Cabling	Campus Cabling for Wi-Fi and Security
------------------------------	----------------------------------	----------------	------------------	---------------------------------------

Customer Space Cabling Infrastructure

MDA Fiber	EDA Fiber	EDA Copper	FiberGuide Raceway
-----------	-----------	------------	--------------------

Reference Designs and Technical Information

MDA Cabinet	MDA Cross-connect 19-in.	MDA Cross-connect FACT ODF	IDF FACT	IDF 19-in.	FEC
-------------	--------------------------	----------------------------	----------	------------	-----



<b>EPX - LGX/1000 Style</b>
36 ports LC-D or 36 ports MPO
No cable management
Basic labeling
Lowest/Standard Density

Cable Attachment Kit		Cable Attachment Kit
		Fiber Cable
LGX/1000 Splice Cassette		LGX/1000 Splice Cassette
EPX LGX/1000 Panel		EPX LGX/1000 Panel
Patch Cord		Patch Cord

<b>EPX - G2 Style</b>
48 ports LC-D or 32 ports MPO
No cable management
Basic labeling

Cable Attachment Kit		Cable Attachment Kit
		Fiber Cable
G2 Splice Cassette		G2 Splice Cassette
EPX - G2 Style Panel		EPX - G2 Style Panel
Patch Cord		Patch Cord

<b>Propel</b>
72 ports LC-D or 72 ports MPO
Front cable management
Labeling option (printer support)
Sliding tray for better cable modules access

Propel Splice Module		Propel Splice Module
6.5 mm OD max		6.5 mm OD max
Propel Panel		Propel Panel
	7 mm OD max	
Patch Cord		Patch Cord

## Direct System Selection Index

FEC	FACT ODF	UMSC	Flex Frame ODF, 19-in. Propel Panels	FOSC 600	19-in. Splice Solutions	Singlemode Fiber Cables	Singlemode Patch Cord, Cable Mgmt Products	Pre-term 19-in. Fiber	Pre-term FACT ODF Fiber	FiberGuide	Copper Category 6A	Powered Fiber	DIN Rail Solutions	Fiber Wall Boxes	2 Post Equipment Racks	imVision®
-----	----------	------	--------------------------------------	----------	-------------------------	-------------------------	--	-----------------------	-------------------------	------------	--------------------	---------------	--------------------	------------------	------------------------	-----------

## Architecture System Selection Index

### Colocation Campus and Building Infrastructure

Fiber Entrance, Meet-Me Room	High Fiber Count DC Interconnect	Campus Cabling	Building Cabling	Campus Cabling for Wi-Fi and Security
------------------------------	----------------------------------	----------------	------------------	---------------------------------------

### Customer Space Cabling Infrastructure

MDA Fiber	EDA Fiber	EDA Copper	FiberGuide Raceway
-----------	-----------	------------	--------------------

### Reference Designs and Technical Information

MDA Cabinet	MDA Cross-connect 19-in.	MDA Cross-connect FACT ODF	IDF FACT	IDF 19-in.	FEC
-------------	--------------------------	----------------------------	----------	------------	-----



## Review 19-in. Splice Solutions System Selection

[EPX - LGX/1000 Style](#)
[EPX - G2 Style](#)
[Propel](#)

Fits to				Description Code	Part Number	
■	EPX Fiber Panels - LGX/1000 Style			EPX-1U-PNL-ENC	760249997	
	EPX 1U sliding panel, accepts (3) LGX/PNL style splice cassettes, modules or panels, providing up to 36 duplex LC ports			EPX-2U-PNL-ENC	760251045	
	EPX 2U sliding panel, accepts (6) LGX/PNL style splice cassettes, modules or panels, providing up to 72 duplex LC ports			EPX-4U-PNL-ENC	760251049	
■	EPX 4U sliding panel, accepts (12) LGX/PNL style splice cassettes, modules or panels, providing up to 144 duplex LC ports					
	Fits to	Fiber	Form Factor	Description Code	Part Number	
	LGX/1000 Style Adapter Packs					
■	LazrSPEED® Adapter Pack, Black, 1000-Type, with 6 Multimode duplex LC adapters, aqua, no shutter			PNL-BK-012-MFA-LC02-AQ-NS	760149344	
	LazrSPEED®, ReadyPATCH® Adapter Pack, Black, 1000-Type, with 6 Multimode duplex LC adapters, aqua, shuttered			PNL-BK-012-MFA-LC02-AQ-SHUTTERED	760067173	
	Adapter Pack, Black, 1000-Type, with 6 TeraSPEED® Singlemode duplex LC adapters, blue, no shutter			PNL-BK-012-SFA-LC02-BL-NS	760149351	
	1000-type Adapter Pack, with 6 TeraSPEED® SM duplex LC adapters, blue			PNL-BK-012-SFA-LC02-BL-SHUTTERED	760067165	
	Adapter Pack, Black, 1000-Type, with 12 LazrSPEED® Multimode duplex LC adapters, aqua, no shutter			PNL-BK-024-MFA-LC02-AQ-NS	760148171	
	Adapter Pack, 1000-type with 12 LazrSPEED® Multimode duplex LC adapters, aqua			PNL-BK-024-MFA-LC02-AQ-SHUTTERED	760028209	
	Adapter Pack, Black, 1000-Type, with 12 TeraSPEED® Singlemode duplex LC adapters, blue, no shutter			PNL-BK-024-SFA-LC02-BL-NS	760148361	
	Adapter Pack, Black, 1000-Type, with 12 TeraSPEED® Singlemode duplex LC Adapters, blue, shuttered			PNL-BK-024-SFA-LC02-BL-SHUTTERED	760027433	
	ReadyPATCH® Adapter Pack, Black, 1000-Type, with six 12 fiber MPO adapters			RFE-PNL-6-MPO	760034280	
	1000-Type Adapter Pack with 12 simplex singlemode MPO adapters, key-up to key-down				760242758	
Fits to	Fiber	Form Factor	Includes Pigtails	Description Code	Part Number	
■	LGX/1000 Style Splice Cassettes					
	OM4 Splicing cassette, 12LC, 900µm			Yes	PNL-CS-12LCX-PT	760221739
	LazrSPEED® Splicing cassette, 24LC, 900µm			Yes	PNL-CS-24LCX-PT	760221697
	TeraSPEED® Splicing cassette, 12LC, 900µm			Yes	PNL-CS-12LCW-PT	760221747
	TeraSPEED® Splicing cassette, OS2, 12 LC/UPC, Ribbon			Yes	PNL-CS-12LCW-RPT	760242688
	TeraSPEED® Splicing cassette, 24LC, 900µm			Yes	PNL-CS-24LCW-PT	760221705
TeraSPEED® Splicing cassette, OS2, 24 LC/UPC, Ribbon			Yes	PNL-CS-24LCW-RPT	760242691	
Fits to				Description Code	Part Number	
■	EPX Fiber Panels - G2 Style					
	EPX 1U sliding panel, accepts (4) G2 style splice cassettes, modules or adapter packs, providing up to 48 duplex LC ports			EPX-1U-MOD-ENC	760249998	
	EPX 2U sliding panel, accepts (8) G2 style splice cassettes, modules or adapter packs, providing up to 96 duplex LC ports			EPX-2U-MOD-ENC	760251044	
EPX 4U sliding panel, accepts (16) G2 style splice cassettes, modules or adapter packs, providing up to 192 duplex LC ports			EPX-4U-MOD-ENC	760251048		
Fits to	Fiber	Form Factor			Part Number	
■	G2 Style Adapter Packs					
	G2 Distribution Adapter Pack 12 LC with internal shutters, Multimode OM4 Aqua			360DPis-24LC-LS	760216754	
	G2 Distribution Adapter Pack 24 LC with internal shutters, Multimode OM5 Lime Green			360DPis-24LC-WB	760236041	
G2 Distribution Adapter Pack 12 LC with internal shutters, Singlemode Blue			360DPis-24LC-SM	760216762		
Fits to	Fiber	Module	Includes Pigtails	Description Code	Part Number	
■	G2 Style Splice Cassettes					
	G2 Splice Cassette 24 LC, OM4, including pigtails			Yes	G2-SP-24LCX-PT	760244927
	G2 Splice Cassette, 24LC with internal shutters, OM4, with pigtails, Method B Enhanced			Yes	G2-SP-24LCX-PT-BE	760255885
	G2 Splice Cassette, 12LC with internal shutters, OM4, with pigtails, Method B Enhanced			Yes	G2-SP-12LCX-PT-BE	760255887
	G2 Splice Cassette, 24LC/UPC with internal shutters, OS2, with ribbon pigtails, Method B Enhanced			Yes	G2-SP-24LCG-RPT-BE	760255884
	G2 Splice Cassette, 12LC/UPC with internal shutters, OS2, with pigtails, Method B Enhanced			Yes	G2-SP-12LCG-PT-BE	760255886
	G2 Splice Cassette 24 LC, OS2, including pigtails			Yes	G2-SP-24LCG-PT	760244929
	G2 blank adapters, 4 pcs				360G2-MOD-BLANK-4PK	760109462
G2 footprint accessories label kit				G2 FLEX LABEL KIT (12pcs)	760245472	
Fits to				Description Code	Part Number	
■	Accessories					
	Cable Attachment Kit for EPX fiber panel				1671273-1	
	Fiber optic splice tray, stackable, for SMOUV splice protectors, 48 splices per tray, SMOUVs and SMOUV holder included			AGL-SPLICE-48	760241378	
	Ribbon Fiber Splice Tray Kit, stackable, 12 ribbon capacity			AGL-SPLICE-48	760243494	
Vertical Cable Guide Kit			VERT-CBL-BKT	760237133		

### Direct System Selection Index

FEC	FACT ODF	UMSC	Flex Frame ODF, 19-in. Propel Panels	FOSC 600	19-in. Splice Solutions	Singlemode Fiber Cables	Singlemode Patch Cord, Cable Mgmt Products	Pre-term 19-in. Fiber	Pre-term FACT ODF Fiber	FiberGuide	Copper Category 6A	Powered Fiber	DIN Rail Solutions	Fiber Wall Boxes	2 Post Equipment Racks	imVision®
-----	----------	------	--------------------------------------	----------	-------------------------	-------------------------	--	-----------------------	-------------------------	------------	--------------------	---------------	--------------------	------------------	------------------------	-----------

### Architecture System Selection Index

#### Colocation Campus and Building Infrastructure

Fiber Entrance, Meet-Me Room	High Fiber Count DC Interconnect	Campus Cabling	Building Cabling	Campus Cabling for Wi-Fi and Security
------------------------------	----------------------------------	----------------	------------------	---------------------------------------

#### Customer Space Cabling Infrastructure

MDA Fiber	EDA Fiber	EDA Copper	FiberGuide Raceway
-----------	-----------	------------	--------------------

#### Reference Designs and Technical Information

MDA Cabinet	MDA Cross-connect 19-in.	MDA Cross-connect FACT ODF	IDF FACT	IDF 19-in.	FEC
-------------	--------------------------	----------------------------	----------	------------	-----



## Review 19-in. Splice Solutions System Selection (continued)

EPX - LGX/1000 Style
EPX - G2 Style
Propel

Fits to		Propel Fiber Panels - Sliding	HU	Description Code	Part Number		
		Propel 1RU sliding tray fiber panel, accepts Propel ULL modules or adapter packs, providing up to 72 duplex LC ports, 72 MPO ports or 144 SN ports (288f)	1	PPL-1U	<a href="#">760252002</a>		
		Propel 2RU sliding tray fiber panel, accepts Propel ULL modules or adapter packs, providing up to 144 duplex LC ports, 144 MPO ports or 288 SN ports (576f)	2	PPL-2U	<a href="#">760252003</a>		
		Propel 4RU sliding tray fiber panel, accepts Propel ULL modules or adapter packs, providing up to 288 duplex LC ports, 288 MPO ports or 576 SN ports (1152f)	4	PPL-4U	<a href="#">760252004</a>		
Fits to		Propel Fiber Panels - Fixed	HU	Description Code	Part Number		
		Propel 1RU fixed tray fiber panel, accepts Propel components, providing up to 48 duplex LC ports, 48 MPO ports or 96 SN ports (192f)	1	PPL-1U-HD-FX	<a href="#">760253796</a>		
		Propel 2RU fixed tray fiber panel, accepts Propel ULL modules or adapter packs, providing up to 96 duplex LC ports, 96 MPO ports or 192 SN ports (384f)	2	PPL-2U-HD-FX	<a href="#">760253797</a>		
		Propel 4RU fixed tray fiber panel, accepts Propel ULL modules or adapter packs, providing up to 192 duplex LC ports, 192 MPO ports or 384 SN ports (768f)	4	PPL-4U-HD-FX	<a href="#">760253798</a>		
Fits to		Propel Fiber Panels - Fixed, Open Rear	HU	Description Code	Part Number		
		Propel 1RU fixed tray open fiber panel, accepts Propel components, providing up to 48 duplex LC ports, 48 MPO ports or 96 SN ports (192f)	1	PPL-1U-HD-FX-OPEN	<a href="#">760254865</a>		
		Propel 2RU fixed tray open fiber panel, accepts Propel components, providing up to 96 duplex LC ports, 96 MPO ports or 192 SN ports (384f)	2	PPL-2U-HD-FX-OPEN	<a href="#">760254908</a>		
Fits to		Splice Cassettes	Fiber	Type	Polarity Method	Description Code	Part Number
		Propel Multimode Splice Cassette, 24LC/UPC with internal shutters, OM4 250µm single fiber pigtails, Method B Enhanced ULL	OM4	Stranded	Method B Enhanced	PPL-SP-24LC-OM4-PT-BEU	<a href="#">760255054</a>
		Propel Multimode Splice Cassette, 24LC/UPC with internal shutters, OM4 ribbon fiber pigtail, Method B Enhanced ULL	OM4	Rollable Ribbon	Method B Enhanced	PPL-SP-24LC-OM4-RPT-BEU	<a href="#">760255057</a>
		Propel Singlemode Splice Cassette, 24LC/UPC with internal shutters, OS2 ribbon fiber pigtail, Method B Enhanced ULL	OS2	Rollable Ribbon	Method B Enhanced	PPL-SP-24LC-SM-RPT-BEU	<a href="#">760255056</a>
		Propel Singlemode Splice Cassette, 24LC/UPC with internal shutters, OS2 250µm single fiber pigtails, Method B Enhanced ULL	OS2	Stranded	Method B Enhanced	PPL-SP-24LC-SM-PT-BEU	<a href="#">760255053</a>
		Propel Singlemode Splice Cassette, 24LC/UPC with internal shutters, OS2 250µm single fiber pigtails, Method A Straight ULL	OS2	Stranded	Method A Pairs Straight	PPL-SP-24LC-SM-PT-ASU	<a href="#">760255081</a>
Fits to		19-Inch Cable Management Accessories	Type	Description Code	Part Number		
		Small universal blocking kit. Used for on-frame blocking and breakout of Rollable Ribon cables into 19-in. Panels	Rollable Ribbon	BK-FP-SML	<a href="#">760238380</a>		
		Large universal blocking kit. Used for on-frame blocking and breakout of Rollable Ribon cables into 19-in. Panels	Rollable Ribbon	BK-FP-LRG	<a href="#">760238381</a>		

### Direct System Selection Index

FEC	FACT ODF	UMSC	Flex Frame ODF, 19-in. Propel Panels	FOSC 600	19-in. Splice Solutions	Singlemode Fiber Cables	Singlemode Patch Cord, Cable Mgmt Products	Pre-term 19-in. Fiber	Pre-term FACT ODF Fiber	FiberGuide	Copper Category 6A	Powered Fiber	DIN Rail Solutions	Fiber Wall Boxes	2 Post Equipment Racks	imVision®
-----	----------	------	--------------------------------------	----------	-------------------------	-------------------------	--	-----------------------	-------------------------	------------	--------------------	---------------	--------------------	------------------	------------------------	-----------

### Architecture System Selection Index

#### Colocation Campus and Building Infrastructure

Fiber Entrance, Meet-Me Room	High Fiber Count DC Interconnect	Campus Cabling	Building Cabling	Campus Cabling for Wi-Fi and Security
------------------------------	----------------------------------	----------------	------------------	---------------------------------------

#### Customer Space Cabling Infrastructure

MDA Fiber	EDA Fiber	EDA Copper	FiberGuide Raceway
-----------	-----------	------------	--------------------

#### Reference Designs and Technical Information

MDA Cabinet	MDA Cross-connect 19-in.	MDA Cross-connect FACT ODF	IDF FACT	IDF 19-in.	FEC
-------------	--------------------------	----------------------------	----------	------------	-----



Select a product for more information.

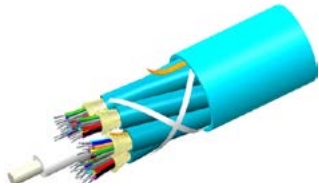

Indoor Distribution Cable



Indoor Rollable Ribbon Central Loose Tube Cable



Indoor Rollable Ribbon Loose Tube Cable



Indoor/Outdoor Rollable Ribbon Central Tube Cable, Interlocking Armored



Indoor/Outdoor Rollable Ribbon Loose Tube Cable, Interlocking Armored



Indoor/Outdoor Rollable Ribbon Central Loose Tube Cable



Indoor/Outdoor Rollable Ribbon Loose Tube Cable

[Learn more about CommScope's Rollable Ribbon Fiber Solutions here.](#)

## Direct System Selection Index

FEC	FACT ODF	UMSC	Flex Frame ODF, 19-in. Propel Panels	FOSC 600	19-in. Splice Solutions	Singlemode Fiber Cables	Singlemode Patch Cord, Cable Mgmt Products	Pre-term 19-in. Fiber	Pre-term FACT ODF Fiber	FiberGuide	Copper Category 6A	Powered Fiber	DIN Rail Solutions	Fiber Wall Boxes	2 Post Equipment Racks	imVision®
-----	----------	------	--------------------------------------	----------	-------------------------	-------------------------	--	-----------------------	-------------------------	------------	--------------------	---------------	--------------------	------------------	------------------------	-----------

## Architecture System Selection Index

### Colocation Campus and Building Infrastructure

Fiber Entrance, Meet-Me Room	High Fiber Count DC Interconnect	Campus Cabling	Building Cabling	Campus Cabling for Wi-Fi and Security
------------------------------	----------------------------------	----------------	------------------	---------------------------------------

### Customer Space Cabling Infrastructure

MDA Fiber	EDA Fiber	EDA Copper	FiberGuide Raceway
-----------	-----------	------------	--------------------

### Reference Designs and Technical Information

MDA Cabinet	MDA Cross-connect 19-in.	MDA Cross-connect FACT ODF	IDF FACT	IDF 19-in.	FEC
-------------	--------------------------	----------------------------	----------	------------	-----





Advances in technology have enabled the data center industry to keep ahead of the insatiable demand for more capacity and bandwidth. Faster processors, higher density storage and high-speed, more cost-effective connectivity have been key contributors to this success.

Rollable ribbon fiber technology is one of the latest technology advances that helps data center managers meet demand while maximizing precious space in pathways and ducts. The inherent flexibility of the rollable ribbon matrix allows it to deliver up to twice as many fibers within the same cable diameter as conventional flat ribbon cables while maintaining the installation advantages that ribbon technology offers.

CommScope's rollable ribbon solutions extend well beyond just fiber cable. From the outside plant networks, to building entrance, meet-me rooms and even extending to customer cages, CommScope offers a comprehensive range of singlemode fiber solutions that fully exploit rollable ribbon fiber technology—offering MTDC operators and their clients faster time-to-service and better utilization of valuable space in the data center.

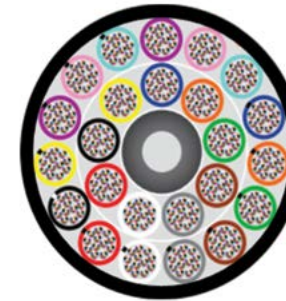
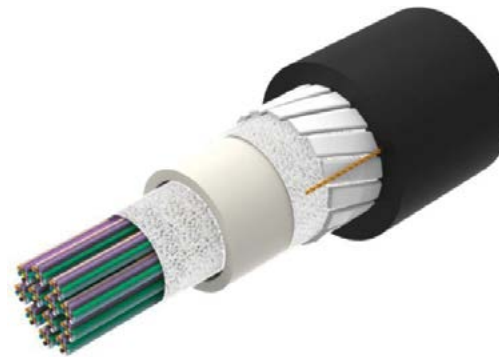

Rollable Ribbon Fiber Cable



Flat Ribbon Fiber Cable

## Direct System Selection Index

FEC	FACT ODF	UMSC	Flex Frame ODF, 19-in. Propel Panels	FOSC 600	19-in. Splice Solutions	Singlemode Fiber Cables	Singlemode Patch Cord, Cable Mgmt Products	Pre-term 19-in. Fiber	Pre-term FACT ODF Fiber	FiberGuide	Copper Category 6A	Powered Fiber	DIN Rail Solutions	Fiber Wall Boxes	2 Post Equipment Racks	imVision®
-----	----------	------	--------------------------------------	----------	-------------------------	-------------------------	--	-----------------------	-------------------------	------------	--------------------	---------------	--------------------	------------------	------------------------	-----------

## Architecture System Selection Index

### Colocation Campus and Building Infrastructure

Fiber Entrance, Meet-Me Room	High Fiber Count DC Interconnect	Campus Cabling	Building Cabling	Campus Cabling for Wi-Fi and Security
------------------------------	----------------------------------	----------------	------------------	---------------------------------------

### Customer Space Cabling Infrastructure

MDA Fiber	EDA Fiber	EDA Copper	FiberGuide Raceway
-----------	-----------	------------	--------------------

### Reference Designs and Technical Information

MDA Cabinet	MDA Cross-connect 19-in.	MDA Cross-connect FACT ODF	IDF FACT	IDF 19-in.	FEC
-------------	--------------------------	----------------------------	----------	------------	-----



CommScope's rollable ribbon technology utilizes partially bonded fiber ribbons composed of 12 fibers. Unlike conventional ribbons, which are fully longitudinally bonded, rollable ribbons are partially bonded. As seen here, the partial bonding process used with rollable ribbons allows them to be easily separated and "rolled" into a cylinder, thus making much better use of space when compared with flat ribbons.

Cables containing rollable ribbon fibers offer significant advantages over flat ribbon fiber cables, including the following:

- Double the fiber density of standard matrix flat ribbons
- Smaller, lighter cables simplify handling and installation
- Significant reduction in splice time through use of mass fusion splicing
- No preferential bend (common in flat matrix ribbons)
- Easy separation for splicing or connectorization

- Smaller bend radii due to smaller cable diameter, allowing smaller telecom spaces such as closures, panels and hand holes
- Outdoor cables available in gel-free construction
- Fiber counts available from 144 to 3,456

OSP rollable ribbon fiber cables offer double the fiber counts compared with flat ribbon fiber cables as shown in the table below comparing several duct sizes.

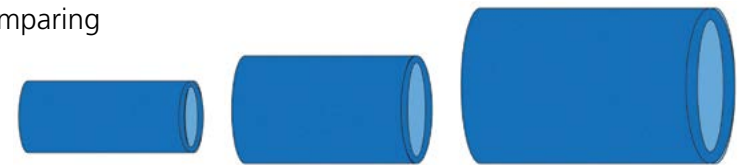

Max Fiber Count	1 in. (2.5 cm) duct	1 1/4 in. (3.2 cm) duct	2 in. (5 cm) duct
Flat Ribbon	432	864	1728
Rollable Ribbon	864	1728	3456

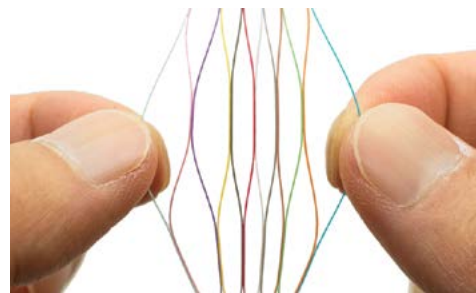

Rollable Ribbon



Conventional Flat Ribbon Matrix (Side View and Top View)

## Direct System Selection Index

FEC	FACT ODF	UMSC	Flex Frame ODF, 19-in. Propel Panels	FOSC 600	19-in. Splice Solutions	Singlemode Fiber Cables	Singlemode Patch Cord, Cable Mgmt Products	Pre-term 19-in. Fiber	Pre-term FACT ODF Fiber	FiberGuide	Copper Category 6A	Powered Fiber	DIN Rail Solutions	Fiber Wall Boxes	2 Post Equipment Racks	imVision®
-----	----------	------	--------------------------------------	----------	-------------------------	-------------------------	--	-----------------------	-------------------------	------------	--------------------	---------------	--------------------	------------------	------------------------	-----------

## Architecture System Selection Index

### Colocation Campus and Building Infrastructure

Fiber Entrance, Meet-Me Room	High Fiber Count DC Interconnect	Campus Cabling	Building Cabling	Campus Cabling for Wi-Fi and Security
------------------------------	----------------------------------	----------------	------------------	---------------------------------------

### Customer Space Cabling Infrastructure

MDA Fiber	EDA Fiber	EDA Copper	FiberGuide Raceway
-----------	-----------	------------	--------------------

### Reference Designs and Technical Information

MDA Cabinet	MDA Cross-connect 19-in.	MDA Cross-connect FACT ODF	IDF FACT	IDF 19-in.	FEC
-------------	--------------------------	----------------------------	----------	------------	-----



Rollable Ribbon Non-Armored Indoor/Outdoor Fiber Optic Cable	Total Number of Fibers	Fibers Per Sub-Unit	Sheath Material	Outer Diameter	Minimum Bend Radius, Loaded	Description Code	Part Number
Indoor/Outdoor, Low Smoke Zero Halogen (LSZH), Riser-Rated, Gel-Free, Central Tube Rollable Ribbon Cable, Black Sheath	144	Single Central Tube	LSZH RISER	0.413 in. (10.5mm)	8.268 in. (210 mm)	Z-144-CN-RR-F12BK/8G1/99G/C	<a href="#">760239021</a>
Indoor/Outdoor, Low Smoke Zero Halogen (LSZH), Riser-Rated, Gel-Free, Central Tube Rollable Ribbon Cable, Black Sheath	288	Single Central Tube	LSZH RISER	0.492 in. (12.5mm)	9.843 in. (250 mm)	Z-288-CN-RR-F12BK/8G1/99G/C	<a href="#">760239022</a>
Indoor/Outdoor, Low Smoke Zero Halogen (LSZH), Riser-Rated, Gel-Free, Central Tube Rollable Ribbon Cable, Black Sheath	432	Single Central Tube	LSZH RISER	0.610 in. (15.5mm)	12.205 in. (310 mm)	Z-432-CN-RR-F12BK/8G1/99G/C	<a href="#">760246293</a>
Indoor/Outdoor, Low Smoke Zero Halogen (LSZH), Riser-Rated, Gel-Free, Central Tube Rollable Ribbon Cable, Black Sheath	576	Single Central Tube	LSZH RISER	0.669 in. (17.0mm)	13.386 in. (340 mm)	Z-576-CN-RR-F12BK/8G1/99G/C	<a href="#">760246294</a>
Indoor/Outdoor, Low Smoke Zero Halogen (LSZH), Riser-Rated, Gel-Free, Central Tube Rollable Ribbon Cable, Black Sheath	864	Single Central Tube	LSZH RISER	0.768 in. (19.5mm)	15.354 in. (390 mm)	Z-864-CN-RR-F12BK/8G1/99G/C	<a href="#">760246164</a>
Indoor/Outdoor, All-Dielectric, Low Smoke Zero Halogen (LSZH), Riser-Rated, Gel-Free, Loose Tube Rollable Ribbon Cable, Black Sheath	1,728	288	LSZH RISER	1.000 in. (25.4 mm)	20.000 in. (508 mm)	Z-1728-LN-RR-F12BK/8G1/99H/B2	<a href="#">760244183</a>
Indoor/Outdoor, All-Dielectric, Low Smoke Zero Halogen (LSZH), Riser-Rated, Gel-Free, Loose Tube Rollable Ribbon Cable, Black Sheath	3,456	576	LSZH RISER	1.083 in. (27.5mm)	16.22 in. (412 mm)	Z-3456-LN-RR-F12BK/8G1/99L/200/C	<a href="#">760250982</a>
Rollable Ribbon Armored Indoor/Outdoor Fiber Optic Cable	Total Number of Fibers	Fibers Per Sub-Unit	Sheath Material	Outer Diameter	Minimum Bend Radius, Loaded	Description Code	Part Number
Indoor/Outdoor, Interlocking Armored, Low Smoke Zero Halogen (LSZH), Riser-Rated, Gel-Free, Central Tube Rollable Ribbon Cable, Black Sheath	144	Single Central Tube	LSZH RISER	0.756 in. (19.2mm)	15.118 in. (384 mm)	Z-144-CZ-RR-F12BK/8G1/99G/B2	<a href="#">760239048</a>
Indoor/Outdoor, Interlocking Armored, Low Smoke Zero Halogen (LSZH), Riser-Rated, Gel-Free, Central Tube Rollable Ribbon Cable, Black Sheath	288	Single Central Tube	LSZH RISER	0.807 in. (20.5 mm)	16.142 in. (410 mm)	Z-288-CZ-RR-F12BK/8G1/99G/B2	<a href="#">760248083</a>
Indoor/Outdoor, Interlocking Armored, Low Smoke Zero Halogen (LSZH), Riser-Rated, Gel-Free, Central Tube Rollable Ribbon Cable, Black Sheath	432	Single Central Tube	LSZH RISER	0.957 in. (24.3 mm)	19.094 in. (485 mm)	Z-432-CZ-RR-F12BK/8G1/99G/B2	<a href="#">760248084</a>
Indoor/Outdoor, Interlocking Armored, Low Smoke Zero Halogen (LSZH), Riser-Rated, Gel-Free, Central Tube Rollable Ribbon Cable, Black Sheath	576	Single Central Tube	LSZH RISER	1.004 in. (25.5 mm)	20.079 in. (510 mm)	Z-576-CZ-RR-F12BK/8G1/99G/B2	<a href="#">760239051</a>
Indoor/Outdoor, Interlocking Armored, Low Smoke Zero Halogen (LSZH), Riser-Rated, Gel-Free, Central Tube Rollable Ribbon Cable, Black Sheath	864	Single Central Tube	LSZH RISER	1.106 in. (28.1 mm)	22.126 in. (562 mm)	Z-864-CZ-RR-F12BK/8G1/99G/B2	<a href="#">760248082</a>
Indoor/Outdoor, Interlocking Armored, Low Smoke Zero Halogen (LSZH), Riser-Rated, Gel-Free, Loose Tube Rollable Ribbon Cable, Black Sheath	1,728	Single Central Tube	LSZH RISER	1.355 in. (34.4mm)	20.315 in. (516 mm)	Z-1728-LZ-RR-F12BK/8G1/99H/B2	<a href="#">760245915</a>
Rollable Ribbon Indoor Fiber Optic Cable	Total Number of Fibers	Fibers Per Sub-Unit	Sheath Material	Outer Diameter	Minimum Bend Radius, Loaded	Description Code	Part Number
Indoor All-Dielectric, Low Smoke Zero Halogen (LSZH), Riser-Rated, Gel-Free, Central Tube Rollable Ribbon Cable, Yellow Sheath	144	Single Central Tube	LSZH RISER	0.413 in. (10.5 mm)	8.268 in. (210 mm)	N-144-CN-RR-F12YL/8G1/99G/B2	<a href="#">760239307</a>
Indoor Plenum All-Dielectric Central Tube Rollable Ribbon Cable OS2, Yellow Sheath	144	Single Central Tube	Plenum	0.378 in. (9.6 mm)	7.598 in. (193 mm)	P-144-CN-RR-F12YL/8G1/99E	<a href="#">760246289</a>
Indoor, All-Dielectric, Low Smoke Zero Halogen (LSZH), Riser-Rated, Gel-Free, Central Tube Rollable Ribbon Cable, Yellow Sheath	288	Single Central Tube	LSZH RISER	0.492 in. (12.5 mm)	9.843 in. (250 mm)	N-288-CN-RR-F12YL/8G1/99G/C	<a href="#">760239308</a>
Indoor Plenum All-Dielectric Central Tube Rollable Ribbon Cable OS2, Yellow Sheath	288	Single Central Tube	Plenum	0.476 in. (12.1 mm)	9.5 in. (241.3 mm)	P-288-CN-RR-F12YL/8G1/99E	<a href="#">760246290</a>
Indoor, All-Dielectric, Low Smoke Zero Halogen (LSZH), Riser-Rated, Gel-Free, Central Tube Rollable Ribbon Cable, Yellow Sheath	432	Single Central Tube	LSZH RISER	0.610 in. (15.5 mm)	12.205 in. (310 mm)	N-432-CN-RR-F12YL/8G1/99G/C	<a href="#">760246291</a>
Indoor, All-Dielectric, Low Smoke Zero Halogen (LSZH), Riser-Rated, Gel-Free, Central Tube Rollable Ribbon Cable, Yellow Sheath	576	Single Central Tube	LSZH RISER	0.672 in. (12.0 mm)	13.386 in. (340 mm)	N-576-CN-RR-F12YL/8G1/99G/C	<a href="#">760246292</a>
Indoor, All-Dielectric, Low Smoke Zero Halogen (LSZH), Riser-Rated, Gel-Free, Central Tube Rollable Ribbon Cable, Yellow Sheath	864	Single Central Tube	LSZH RISER	0.768 in. (19.5 mm)	15.354 in. (390 mm)	N-864-CN-RR-F12YL/8G1/99G/C	<a href="#">760242275</a>
Indoor, All-Dielectric, Low Smoke Zero Halogen (LSZH), Riser-Rated, Gel-Free, Loose Tube Rollable Ribbon Cable, Yellow Sheath	1,728	288	LSZH RISER	1.000 in. (25.4 mm)	20.000 in. (508 mm)	N-1728-LN-RR-F12YL/8G1/99H/B2	<a href="#">760244182</a>
Distribution Non-Armored Indoor Fiber Optic Cable	Total Number of Fibers	Fibers Per Sub-Unit	Sheath Material	Outer Diameter	Minimum Bend Radius, Loaded	Description Code	Part Number
TeraSPEED Plenum Distribution Cable, 6 fiber single mode, single-unit OS2	6	6	Plenum	0.187 in. (4.74 mm)	2.795 in. (71 mm)	P-006-DS-8W-FSUYL	<a href="#">760004333</a>
TeraSPEED Plenum Distribution Cable, 12 fiber single-unit OS2	12	12	Plenum	0.227 in. (5.77 mm)	3.386 in. (86 mm)	P-012-DS-8W-FSUYL	<a href="#">760004358</a>
TeraSPEED Plenum Distribution Cable, 24 fiber single-unit OS2	24	24	Plenum	0.335 in. (8.5 mm)	5 in. (127 mm)	P-024-DS-8W-FSUYL	<a href="#">760018630</a>
TeraSPEED Plenum Distribution Cable, 48 fiber single-unit OS2	48	12	Plenum	0.587 in. (14.91 mm)	8.819 in. (224 mm)	P-048-DS-8W-FMUYL	<a href="#">760004382</a>
TeraSPEED Plenum Distribution Cable, 96 fiber multi-unit with 12 fiber subunits OS2	96	12	Plenum	0.902 in. (22.91 mm)	13.543 in. (344 mm)	P-096-DS-8W-FMUYL	<a href="#">760018051</a>
TeraSPEED Plenum Distribution Cable, 144 fiber multi-unit with 12 fiber subunits OS2	144	12	Plenum	0.961 in. (24.41 mm)	14.409 in. (366 mm)	P-144-DS-8W-FMUYL	<a href="#">760018895</a>
LazrSPEED Plenum Distribution Cable, 6 fiber single-unit OM4	6	6	Plenum	0.187 in. (4.74 mm)	2.795 in. (71 mm)	P-006-DS-5K-FSUAQ	<a href="#">760012138</a>
LazrSPEED Plenum Distribution Cable, 12 fiber single-unit OM4	12	12	Plenum	0.227 in. (5.77 mm)	3.386 in. (86 mm)	P-012-DS-5K-FSUAQ	<a href="#">760006411</a>
LazrSPEED Plenum Distribution Cable, 24 fiber single-unit OM4	24	24	Plenum	0.335 in. (8.5 mm)	5.000 in. (127 mm)	P-024-DS-5K-FSUAQ	<a href="#">760018697</a>
LazrSPEED Plenum Distribution Cable, 48 fiber multi-unit with 12 fiber subunits OM4	48	12	Plenum	0.587 in. (14.91 mm)	8.819 in. (224 mm)	P-048-DS-5K-FMUAQ	<a href="#">760024554</a>
LazrSPEED Plenum Distribution Cable, 96 fiber multi-unit with 12 fiber subunits OM4	96	12	Plenum	0.902 in. (22.91 mm)	13.543 in. (344 mm)	P-096-DS-5K-FMUAQ	<a href="#">760021691</a>
LazrSPEED Plenum Distribution Cable, 144 fiber multi-unit with 12 fiber subunits OM4	144	12	Plenum	0.961 in. (24.41 mm)	14.409 in. (366 mm)	P-144-DS-5K-FMUAQ	<a href="#">760024869</a>

## Direct System Selection Index

FEC	FACT ODF	UMSC	Flex Frame ODF, 19-in. Propel Panels	FOSC 600	19-in. Splice Solutions	Singlemode Fiber Cables	Singlemode Patch Cord, Cable Mgmt Products	Pre-term 19-in. Fiber	Pre-term FACT ODF Fiber	FiberGuide	Copper Category 6A	Powered Fiber	DIN Rail Solutions	Fiber Wall Boxes	2 Post Equipment Racks	imVision®
-----	----------	------	--------------------------------------	----------	-------------------------	-------------------------	--	-----------------------	-------------------------	------------	--------------------	---------------	--------------------	------------------	------------------------	-----------

## Architecture System Selection Index

### Colocation Campus and Building Infrastructure

Fiber Entrance, Meet-Me Room	High Fiber Count DC Interconnect	Campus Cabling	Building Cabling	Campus Cabling for Wi-Fi and Security
------------------------------	----------------------------------	----------------	------------------	---------------------------------------

### Customer Space Cabling Infrastructure

MDA Fiber	EDA Fiber	EDA Copper	FiberGuide Raceway
-----------	-----------	------------	--------------------

### Reference Designs and Technical Information

MDA Cabinet	MDA Cross-connect 19-in.	MDA Cross-connect FACT ODF	IDF FACT	IDF 19-in.	FEC
-------------	--------------------------	----------------------------	----------	------------	-----



Non-Armored Indoor Rollable Ribbon MP Fiber Optic Cable -Smaller OD & Bend Radius	Total Number of Fibers	Fibers Per Ribbon	Sheath Material	Outer Diameter	Minimum Bend Radius, Loaded	Description Code	Part Number
Indoor LSZH Riser Rollable Ribbon Dual Rated Backbone Cable. G.657.A2/B2   G.657.A2/B2	12	12	LSZH RISER	0.228 in. (5.8 mm)	1.811 in. (46 mm)	N-012-MP-RR-F12YL/8G1/99N/C	<a href="#">760251515</a>
Indoor LSZH Riser Rollable Ribbon Dual Rated Backbone Cable. G.657.A2/B2   G.657.A2/B2	24	12	LSZH RISER	0.228 in. (5.8 mm)	1.811 in. (46 mm)	N-024-MP-RR-F12YL/8G1/99N/C	<a href="#">760251516</a>
Indoor Plenum Rollable Ribbon Dual Rated Backbone Cable. G.657.A2/B2   G.657.A2/B2	24	12	PLENUM	0.213 in. (5.4 mm)	4.252 in. (108mm)	P-024-MP-RR-F12YL/8G1/99N	<a href="#">760251512</a>
Indoor LSZH Riser Rollable Ribbon Dual Rated Backbone Cable. G.657.A2/B2   G.657.A2/B2	48	12	LSZH RISER	0.260 in. (6.6 mm)	2.087 in. (53 mm)	N-048-MP-RR-F12YL/8G1/99N/C	<a href="#">760251517</a>
Indoor Plenum Rollable Ribbon Dual Rated Backbone Cable. G.657.A2/B2   G.657.A2/B2	48	12	PLENUM	0.228 in. (5.8 mm)	4.567 in. (116 mm)	P-048-MP-RR-F12YL/8G1/99N	<a href="#">760251513</a>
Indoor LSZH Riser Rollable Ribbon Dual Rated Backbone Cable. G.657.A2/B2   G.657.A2/B2	72	12	LSZH RISER	0.283 in (7.2 mm)	2.283 in. (58 mm)	N-072-MP-RR-F12YL/8G1/99N/C	<a href="#">760251518</a>
Indoor Plenum Rollable Ribbon Dual Rated Backbone Cable. G.657.A2/B2   G.657.A2/B2	72	12	PLENUM	0.244 in. (6.2 mm)	4.882 in. (124 mm)	P-072-MP-RR-F12YL/8G1/99N	<a href="#">760251514</a>
Indoor LSZH Riser Rollable Ribbon Dual Rated Backbone Cable. G.657.A2/B2   G.657.A2/B2	96	12	LSZH RISER	0.307 in (7.8 mm)	2.441 in. (62 mm)	N-096-MP-RR-F12YL/8G1/99N/C	<a href="#">760251519</a>
Indoor LSZH Riser Rollable Ribbon Dual Rated Backbone Cable. G.657.A2/B2   G.657.A2/B2	144	12	LSZH RISER	0.362 in (9.2 mm)	2.913 in. (74 mm)	N-144-MP-RR-F12YL/8G1/99N/C	<a href="#">760251520</a>
Loose Tube Cable Outdoor, Armored	Total Number of Fibers	Fibers Per Ribbon	Sheath Material	Outer Diameter	Minimum Bend Radius, Loaded	Description Code	Part Number
Singlemode OS2 Single Jacket/Single Armor, Gel-Free, Outdoor Stranded Loose Tube Cable, 48 fibers	48	12	OSP	0.453 in. (11.5 mm)	6.811 in. (173 mm)	D-048-LA-8W-F12NS	<a href="#">760053314</a>
Singlemode OS2 Single Jacket/Single Armor, Gel-Free, Outdoor Stranded Loose Tube Cable, 96 fibers	96	12	OSP	0.528 in. (13.4 mm)	7.913 in. (201 mm)	D-096-LA-8W-F12NS	<a href="#">760053348</a>
Singlemode OS2 Single Jacket/Single Armor, Gel-Free, Outdoor Stranded Loose Tube Cable, 144 fibers	144	12	OSP	0.673 in. (17.1 mm)	10.118 in. (257 mm)	D-144-LA-8W-F12NS	<a href="#">760053355</a>
Singlemode OS2 Single Jacket/Single Armor, Gel-Free, Outdoor Stranded Loose Tube Cable, 288 fibers	288	12	OSP	0.772 in. (19.6 mm)	11.575 in. (294 mm)	D-288-LA-8W-F12NS	<a href="#">760053363</a>

## Direct System Selection Index

FEC	FACT ODF	UMSC	Flex Frame ODF, 19-in. Propel Panels	FOSC 600	19-in. Splice Solutions	Singlemode Fiber Cables	Singlemode Patch Cord, Cable Mgmt Products	Pre-term 19-in. Fiber	Pre-term FACT ODF Fiber	FiberGuide	Copper Category 6A	Powered Fiber	DIN Rail Solutions	Fiber Wall Boxes	2 Post Equipment Racks	imVision®
-----	----------	------	--------------------------------------	----------	-------------------------	-------------------------	--	-----------------------	-------------------------	------------	--------------------	---------------	--------------------	------------------	------------------------	-----------

## Architecture System Selection Index

### Colocation Campus and Building Infrastructure

Fiber Entrance, Meet-Me Room	High Fiber Count DC Interconnect	Campus Cabling	Building Cabling	Campus Cabling for Wi-Fi and Security
------------------------------	----------------------------------	----------------	------------------	---------------------------------------

### Customer Space Cabling Infrastructure

MDA Fiber	EDA Fiber	EDA Copper	FiberGuide Raceway
-----------	-----------	------------	--------------------

### Reference Designs and Technical Information

MDA Cabinet	MDA Cross-connect 19-in.	MDA Cross-connect FACT ODF	IDF FACT	IDF 19-in.	FEC
-------------	--------------------------	----------------------------	----------	------------	-----



Fiber Optic Rollable Ribbon Breakout Kits	Fibers	Description Code	Part Number
Fiber Optic Ribbon Breakout Kit, for IFC cable. 12F/ribbon, 72F/tube, 11-15 mm central tube outside diameter, 6 tubes/leg	72	<b>BLK-RIFC-A06D0</b>	
Fiber Optic Rollable Ribbon Breakout Kit, 12F/ribbon, 12F/tube, 144 fiber cable	144	BLK-ROLB-A12-144	<b>760245329</b>
Fiber Optic Rollable Ribbon Breakout Kit, 12F/ribbon, 12F/tube, 288 fiber cable	288	BLK-ROLB-A24-288-NM	<b>760245330</b>
Fiber Optic Rollable Ribbon Breakout Kit, 12F/ribbon, 12F/tube, 432 fiber cable	432	BLK-ROLB-A36-432-NM	<b>760245331</b>
Fiber Optic Rollable Ribbon Breakout Kit, 12F/ribbon, 12F/tube, 576 fiber cable	576	BLK-ROLB-A48-576-NM	<b>760245332</b>
Fiber Optic Rollable Ribbon Breakout Kit, 12F/ribbon, 12F/tube, 864 fiber cable	864	BLK-ROLB-A72-864-NM	<b>760245333</b>
Armored Cable Fitting Brackets and Accessories		Description Code	Part Number
Bracket for Armor Fitting, 1/2 NPT		BAF-1/2-NPT	<b>760122895</b>
Bracket for Armor Fitting, 1-1/2 NPT		BAF-1-1/2-NPT	<b>760122937</b>
Bracket for Armor Fitting, 1-1/4 NPT		BAF-1-1/4-NPT	<b>760122929</b>
Bracket for Armor Fitting, 1 NPT		BAF-1-NPT	<b>760122911</b>
Bracket for Armor Fitting, 3/4 NPT		BAF-3/4-NPT	<b>760122903</b>
Universal mounting bracket for Cabinet mount applications for attaching cables or breakout kits		UMB-CMB-LG	<b>760239861</b>
Universal mounting bracket for Rack mount applications for attaching cables or breakout kits		UMB-RMB-LG	<b>760239859</b>
InstaPATCH Plus Attachment Bracket, Rack Mounted, Five 3/4" fittings		RMB-5-3/4	<b>760058701</b>
InstaPATCH Plus Attachment Bracket, Rack Mounted, Six 1/2" fittings		RMB-6-1/2	<b>760058677</b>
InstaPATCH Plus Attachment Bracket, Rack Mounted, Six 3/8" fittings		RMB-6-3/8	<b>760058685</b>

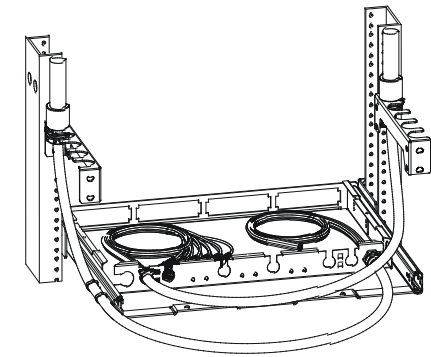
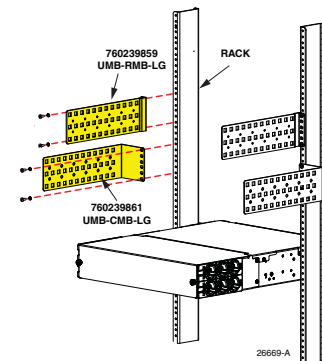

InstaPATCH Plus Attachment Bracket

## Direct System Selection Index

FEC	FACT ODF	UMSC	Flex Frame ODF, 19-in. Propel Panels	FOSC 600	19-in. Splice Solutions	Singlemode Fiber Cables	Singlemode Patch Cord, Cable Mgmt Products	Pre-term 19-in. Fiber	Pre-term FACT ODF Fiber	FiberGuide	Copper Category 6A	Powered Fiber	<a href="#">DIN Rail Solutions</a>	<a href="#">Fiber Wall Boxes</a>	<a href="#">2 Post Equipment Racks</a>	<a href="#">imVision®</a>
-----	----------	------	--------------------------------------	----------	-------------------------	-------------------------	--	-----------------------	-------------------------	------------	--------------------	---------------	------------------------------------	----------------------------------	--	---------------------------

## Architecture System Selection Index

### Colocation Campus and Building Infrastructure

Fiber Entrance, Meet-Me Room	High Fiber Count DC Interconnect	Campus Cabling	Building Cabling	Campus Cabling for Wi-Fi and Security
------------------------------	----------------------------------	----------------	------------------	---------------------------------------

### Customer Space Cabling Infrastructure

MDA Fiber	EDA Fiber	EDA Copper	FiberGuide Raceway
-----------	-----------	------------	--------------------

### Reference Designs and Technical Information

MDA Cabinet	MDA Cross-connect 19-in.	MDA Cross-connect FACT ODF	IDF FACT	IDF 19-in.	FEC
-------------	--------------------------	----------------------------	----------	------------	-----



## LC/LC UPC Singlemode

	Length	Description Code	Part Number
	3 ft	UDGLLULK2-JXF003	<a href="#">UDGLLULK2</a>
	7 ft	UDGLLULK2-JXF007	<a href="#">UDGLLULK2</a>
	10 ft	UDGLLULK2-JXF010	<a href="#">UDGLLULK2</a>
	16 ft	UDGLLULK2-JXF016	<a href="#">UDGLLULK2</a>
	23 ft	UDGLLULK2-JXF023	<a href="#">UDGLLULK2</a>
	33 ft	UDGLLULK2-JXF033	<a href="#">UDGLLULK2</a>

LC/APC patchcords can be found [here](#)

Cable Management	Description Code	Part Number
Overlength storage, 4U	N/A	<a href="#">1671711-1</a>
Horizontal cable through, 2U, single sided	HKT-19-SS-2U	<a href="#">760072959</a>
Horizontal cable through, 3U, single sided	HKT-19-SS-3U	<a href="#">760072967</a>
Cable Manager 1U	N/A	<a href="#">1671495-1</a>
Cable Manager 2U	N/A	<a href="#">1671495-2</a>
Cable Manager 4U	N/A	<a href="#">1671495-4</a>
Cable Manager 6U	N/A	<a href="#">1671495-6</a>
Cable Manager 15U	N/A	<a href="#">1-1671495-5</a>
Filler/Blank Panel, 1U x 19-in., Solid, Black	FPANEL-19-1U	<a href="#">760162065</a>
1U Patchcord Management	HCM-19-SS-1U-EMEA	<a href="#">760038240</a>

## Direct System Selection Index

FEC	FACT ODF	UMSC	Flex Frame ODF, 19-in. Propel Panels	FOSC 600	19-in. Splice Solutions	Singlemode Fiber Cables	Singlemode Patch Cord, Cable Mgmt Products	Pre-term 19-in. Fiber	Pre-term FACT ODF Fiber	FiberGuide	Copper Category 6A	Powered Fiber	DIN Rail Solutions	Fiber Wall Boxes	2 Post Equipment Racks	imVision®
-----	----------	------	--------------------------------------	----------	-------------------------	-------------------------	--	-----------------------	-------------------------	------------	--------------------	---------------	--------------------	------------------	------------------------	-----------

## Architecture System Selection Index

### Colocation Campus and Building Infrastructure

Fiber Entrance, Meet-Me Room	High Fiber Count DC Interconnect	Campus Cabling	Building Cabling	Campus Cabling for Wi-Fi and Security
------------------------------	----------------------------------	----------------	------------------	---------------------------------------

### Customer Space Cabling Infrastructure

MDA Fiber	EDA Fiber	EDA Copper	FiberGuide Raceway
-----------	-----------	------------	--------------------

### Reference Designs and Technical Information

MDA Cabinet	MDA Cross-connect 19-in.	MDA Cross-connect FACT ODF	IDF FACT	IDF 19-in.	FEC
-------------	--------------------------	----------------------------	----------	------------	-----



# Pre-terminated Fiber Systems

Pre-terminated 19-in. Fiber System Solutions

Pre-terminated FACT ODF Fiber System Solutions

Pre-terminated Stubbed Assemblies



## EPX – LGX/1000 Style

36 ports LC-D or  
36 ports MPO

No cable management

Basic labeling

Lowest/Standard Density



LGX/1000 to  
G2 Adapter



G2 Module



EPX LGX/1000 Panel



Patch Cord



MPO Trunk or  
Array Trunk



EPX LGX/1000 Panel



Patch Cord



LGX/1000 to  
G2 Adapter



G2 Module

## EPX - G2 Style

48 ports LC-D or  
32 ports MPO

No cable management

Basic labeling



G2 Module



MPO Trunk or  
Array Trunk



EPX - G2 Style Panel



Patch Cord



G2 Module



EPX - G2 Style Panel



Patch Cord

## Propel

72 ports MPO or 144  
ports SN or 72 ports LC-D

Front cable management

Labeling option  
(printer support)

Sliding tray for better  
cable modules access

Panels available in 1, 2  
and 4RU



Propel Module



MPO Trunk or  
Array Trunk



Propel Panel



Patch Cord



Propel Module



Propel Panel



Patch Cord

## Evolve Mixed Media

For mixed copper and  
fiber installations

Fiber 48 ports LC-D or  
32 ports MPO; Copper:  
24 RJ45 ports

No cable management

Basic labeling

Panels available in 1RU



G2 Module



MPO Trunk or  
Array Trunk



Evolve Panel



Patch Cord



G2 Module



Evolve Panel



Pre-term  
Category 6A  
Copper



Pre-term  
Category 6A  
Copper



Patch Cord

## Direct System Selection Index

FEC	FACT ODF	UMSC	Flex Frame ODF, 19-in. Propel Panels	FOSC 600	19-in. Splice Solutions	Singlemode Fiber Cables	Singlemode Patch Cord, Cable Mgmt Products	Pre-term 19-in. Fiber	Pre-term FACT ODF Fiber	FiberGuide	Copper Category 6A	Powered Fiber	DIN Rail Solutions	Fiber Wall Boxes	2 Post Equipment Racks	imVision®
-----	----------	------	--------------------------------------	----------	-------------------------	-------------------------	--	-----------------------	-------------------------	------------	--------------------	---------------	--------------------	------------------	------------------------	-----------

## Architecture System Selection Index

### Colocation Campus and Building Infrastructure

Fiber Entrance, Meet-Me Room	High Fiber Count DC Interconnect	Campus Cabling	Building Cabling	Campus Cabling for Wi-Fi and Security
------------------------------	----------------------------------	----------------	------------------	---------------------------------------

### Customer Space Cabling Infrastructure

MDA Fiber	EDA Fiber	EDA Copper	FiberGuide Raceway
-----------	-----------	------------	--------------------

### Reference Designs and Technical Information

MDA Cabinet	MDA Cross-connect 19-in.	MDA Cross-connect FACT ODF	IDF FACT	IDF 19-in.	FEC
-------------	--------------------------	----------------------------	----------	------------	-----





Review Pre-terminated 19-in. Fiber System Selection here.

EPX - LGX/1000 Style

EPX - G2 Style

Propel

Evolve Mixed Media

Fits to		Description Code	Part Number			
■	EPX Fiber Panels - LGX/1000 Style					
	EPX 1U sliding panel, accepts (3) LGX/PNL style splice cassettes, modules or panels, providing up to 36 duplex LC ports	EPX-1U-PNL-ENC	<a href="#">760249997</a>			
	EPX 2U sliding panel, accepts (6) LGX/PNL style splice cassettes, modules or panels, providing up to 72 duplex LC ports	EPX-2U-PNL-ENC	<a href="#">760251045</a>			
	EPX 4U sliding panel, accepts (12) LGX/PNL style splice cassettes, modules or panels, providing up to 144 duplex LC ports	EPX-4U-PNL-ENC	<a href="#">760251049</a>			
Fits to	EPX Fiber Panels - G2 Style	Description Code	Part Number			
■	EPX 1U sliding panel, accepts (4) G2 style splice cassettes, modules or adapter packs, providing up to 48 duplex LC ports	EPX-1U-MOD-ENC	<a href="#">760249998</a>			
	EPX 2U sliding panel, accepts (8) G2 style splice cassettes, modules or adapter packs, providing up to 96 duplex LC ports	EPX-2U-MOD-ENC	<a href="#">760251044</a>			
	EPX 4U sliding panel, accepts (16) G2 style splice cassettes, modules or adapter packs, providing up to 192 duplex LC ports	EPX-4U-MOD-ENC	<a href="#">760251048</a>			
Fits to	Propel Fiber Panels - Sliding	U Height	Description Code	Part Number		
■	Propel 1RU sliding tray fiber panel, accepts Propel ULL modules or adapter packs, providing up to 72 duplex LC ports, 72 MPO ports or 144 SN ports (288f)	1	PPL-1U	<a href="#">760252002</a>		
	Propel 2RU sliding tray fiber panel, accepts Propel ULL modules or adapter packs, providing up to 144 duplex LC ports, 144 MPO ports or 288 SN ports (576f)	2	PPL-2U	<a href="#">760252003</a>		
	Propel 4RU sliding tray fiber panel, accepts Propel ULL modules or adapter packs, providing up to 288 duplex LC ports, 288 MPO ports or 576 SN ports (1152f)	4	PPL-4U	<a href="#">760252004</a>		
Fits to	Propel Fiber Panels - Fixed	U Height	Description Code	Part Number		
■	Propel 1RU fixed tray fiber panel, accepts Propel components, providing up to 48 duplex LC ports, 48 MPO ports or 96 SN ports (192f)	1	PPL-1U-HD-FX	<a href="#">760253796</a>		
	Propel 2RU fixed tray fiber panel, accepts Propel ULL modules or adapter packs, providing up to 96 duplex LC ports, 96 MPO ports or 192 SN ports (384f)	2	PPL-2U-HD-FX	<a href="#">760253797</a>		
	Propel 4RU fixed tray fiber panel, accepts Propel ULL modules or adapter packs, providing up to 192 duplex LC ports, 192 MPO ports or 384 SN ports (768f)	4	PPL-4U-HD-FX	<a href="#">760253798</a>		
Fits to	Propel Fiber Panels - Fixed, Open Rear	U Height	Description Code	Part Number		
■	Propel 1RU fixed tray open fiber panel, accepts Propel components, providing up to 48 duplex LC ports, 48 MPO ports or 96 SN ports (192f)	1	PPL-1U-HD-FX-OPEN	<a href="#">760254865</a>		
	Propel 2RU fixed tray open fiber panel, accepts Propel components, providing up to 96 duplex LC ports, 96 MPO ports or 192 SN ports (384f)	2	PPL-2U-HD-FX-OPEN	<a href="#">760254908</a>		
Fits to	Evolve Mixed Media Panels	Copper Technology	Description Code	Part Number		
■	SYSTIMAX GigaSPEED® X10D® and GigaSPEED XL® Evolve 1U U/UTP Panel Kit	U/UTP	360-E-KIT-1U	<a href="#">760155739</a>		
Fits to	Evolve Mixed Media Panels Accessories	Description Code	Part Number			
■	SYSTIMAX 360 1100 Evolve G2 BEZEL (Cool Gray)	360-1100-E-FB-4PK	<a href="#">760175877</a>			
	SYSTIMAX 360 1100 Evolve Fiber Cable Management	361 1100-E-FCM	<a href="#">760175919</a>			
	SYSTIMAX 360 1100 Evolve G2 BEZEL (Blank)	360-1100-E-BB	<a href="#">760165191</a>			
Fits to	Propel Modules & Adapter Packs	Connector	Fiber	Form Factor	Description Code	Part Number
■	Propel pass-through adapter pack, multimode OM4, 6 duplex LC ports	LC	OM4	Adapter Pack	PPL-AP-12-LC-OM4	<a href="#">760252363</a>
	Propel pass-through adapter pack, multimode OM5, 6 duplex LC ports	LC	OM5	Adapter Pack	PPL-AP-12-LC-OM5	<a href="#">760252364</a>
	Propel pass-through adapter pack, singlemode, 6 duplex LC/UPC ports	LC	OS2	Adapter Pack	PPL-AP-12-LC-SM	<a href="#">760252362</a>
	Propel ULL Multimode OM4 MPO-12 Distribution Module, 12 duplex LC to 2X12f MPO/ UPC non-pinned, Method B Enhanced	MPO12	OM4	Distribution Module	PPL-DM-12U-24LC-OM4-BEU	<a href="#">760252346</a>
	Propel ULL Multimode OM5 MPO-12 Distribution Module, 12 duplex LC to 2X12f MPO/ UPC non-pinned, Method B Enhanced	MPO12	OM5	Distribution Module	PPL-DM-12U-24LC-OM5-BEU	<a href="#">760252347</a>
	Propel ULL Singlemode MPO-12 Distribution Module, 12 duplex LC/UPC to 2X12f MPO/APC non-pinned, Method B Enhanced	MPO12	OS2	Distribution Module	PPL-DM-12AU-24LC-SM-BEU	<a href="#">760252348</a>
	Propel pass-through adapter pack, 12 MPO ports, Type B	MPO12	Universal	Adapter Pack	PPL-AP-12-MPO-ALL-B	<a href="#">760252374</a>

## Direct System Selection Index

FEC	FACT ODF	UMSC	Flex Frame ODF, 19-in. Propel Panels	FOSC 600	19-in. Splice Solutions	Singlemode Fiber Cables	Singlemode Patch Cord, Cable Mgmt Products	Pre-term 19-in. Fiber	Pre-term FACT ODF Fiber	FiberGuide	Copper Category 6A	Powered Fiber	DIN Rail Solutions	Fiber Wall Boxes	2 Post Equipment Racks	imVision®
-----	----------	------	--------------------------------------	----------	-------------------------	-------------------------	--	-----------------------	-------------------------	------------	--------------------	---------------	--------------------	------------------	------------------------	-----------

## Architecture System Selection Index

### Colocation Campus and Building Infrastructure

Fiber Entrance, Meet-Me Room	High Fiber Count DC Interconnect	Campus Cabling	Building Cabling	Campus Cabling for Wi-Fi and Security
------------------------------	----------------------------------	----------------	------------------	---------------------------------------

### Customer Space Cabling Infrastructure

MDA Fiber	EDA Fiber	EDA Copper	FiberGuide Raceway
-----------	-----------	------------	--------------------



































### Reference Designs and Technical Information

MDA Cabinet	MDA Cross-connect 19-in.	MDA Cross-connect FACT ODF	IDF FACT	IDF 19-in.	FEC
-------------	--------------------------	----------------------------	----------	------------	-----



## Review Pre-terminated 19-in. Fiber System Selection here.

[EPX - LGX/1000 Style](#)
[EPX - G2 Style](#)
[Propel](#)
[Evolve Mixed Media](#)

Fits to	LGX/1000 To G2 Module Style Adapter	Form Factor	Description Code	Part Number		
	1000 Style to 360 Adapter Pack Bracket Kit (Kit of 3). Used with G2 ULL MPO to LC Modules	Adapter Bracket	1000-360-ADPT-BRKT-KIT	<a href="#">760198325</a>		
Fits to	G2 Fiber Modules/Adapter Packs	Connector	Fiber Type	Form Factor	Description Code	Part Number
 	G2 ULL MPO-12 distribution module, 24LC to 2x12f MPO unpinned, OM4 internal shutter	MPO-12 / LC	OM4	Distribution Module	DM12-24LC-LS-ULL	<a href="#">760236110</a>
	G2 ULL MPO-12 distribution module, 24LC to 2x12f MPO unpinned, OM5 Wideband, internal shutter	MPO-12 / LC	OM5	Distribution Module	DM12-24LC-WB-ULL	<a href="#">760236111</a>
	G2 ULL MPO-12 distribution module, 24LC to 2x12f MPOs unpinned, singlemode internal shutter	MPO-12 / LC	OS2	Distribution Module	DM12-24LC-SM-ULL	<a href="#">760238083</a>
	G2 ULL 2x3 LazrSPEED® OM4 Conversion Module, (2) MPO-12 unpinned ports rear, (3) MPO-8 pinned front	MPO-12 / MPO-8	OM4	Conversion Module	CM12-2x3-LS-ULL	<a href="#">760237217</a>
	G2 ULL 2x3 LazrSPEED OM5 Conversion Module, (2) MPO-12 unpinned ports rear, (3) MPO-8 pinned front	MPO-12 / MPO-8	OM5	Conversion Module	CM12-2x3-WB-ULL	<a href="#">760237218</a>
	G2 ULL 2x3 Singlemode Conversion Module, (2) MPO-12 unpinned ports rear, (3) MPO-8 pinned front	MPO-12 / MPO-8	OS2	Conversion Module	CM12-2X3-SM-ULL	<a href="#">760237216</a>
	G2 Distribution Adapter Pack 24 LC with internal shutters, Multimode OM4 Aqua	LC	OM4	Adapter Pack	360DPis-24LC-LS	<a href="#">760216754</a>
	G2 Distribution Adapter Pack 24 LC with internal shutters, Multimode OM5 Lime Green	LC	OM5	Adapter Pack	360DPis-24LC-WB	<a href="#">760236041</a>
	G2 Distribution Adapter Pack 24 LC with internal shutters, Singlemode Blue	LC	OS2	Adapter Pack	360DPis-24LC-SM	<a href="#">760216762</a>
	G2 Distribution Adapter Pack, 360DP-8MPO, 8 x MPO	MPO	Universal	Adapter Pack	360DP-8MPO	<a href="#">760107524</a>
G2 blank adapters, 4 pcs	N/A	N/A	Blank Plate	360G2-MOD-BLANK-4PK	<a href="#">760109462</a>	
Fits to	Cable Management	Fits to Reference Design			Description Code	Part Number
   	Overlength storage, 4U					<a href="#">1671711-1</a>
	Horizontal cable through, 1U, single sided					HKT-19-SS-1U <a href="#">760072942</a>
	Horizontal cable through, 2U, single sided					HKT-19-SS-2U <a href="#">760072959</a>
	Horizontal cable through, 3U, single sided					HKT-19-SS-3U <a href="#">760072967</a>
	Cable Manager 1U					<a href="#">1671495-1</a>
	Cable Manager 2U					<a href="#">1671495-2</a>
	Cable Manager 4U					<a href="#">1671495-4</a>
	Cable Manager 6U					<a href="#">1671495-6</a>
	Cable Manager 15U					<a href="#">1-1671495-5</a>
	Filler/Blank Panel, 1U x 19-in., Solid, Black					FPANEL-19-1U <a href="#">760162065</a>
	1U Patchcord Management					HCM-19-SS-1U <a href="#">760038240</a>
	Universal Mounting Bracket					360-UMB <a href="#">760117564</a>
	3 in (76 mm) Channel x 9.4 in (239 mm) H - 19 in (482.6 mm) Overhead Patch Panel Rack (4U) 3/8 Sq Punch, Black					OVRHRDRACK <a href="#">760157800</a>
	3 in (76 mm) Channel x 9.4 in (239 mm) H - 19 in (482.6 mm) Overhead Patch Panel Rack (4U) 3/8 Sq Punch, with Mini Vertical Cable Management, Black					OVRHRDRACKVCM <a href="#">760158592</a>
	Mini Vertical Cable Management for Overhead Patch Panel Rack, 4U, black					OVRHDVCM <a href="#">760164061</a>
	Overhead Rack-to-Wire Basket Installation Kit					OVRHRDRACKBSKTKIT <a href="#">760165282</a>
	3 in (76 mm) Channel x 9.4 in (239 mm) H - 19 in (482.6 mm) Overhead Patch Panel Rack (6U) 3/8 Sq Punch, Black					OVRHRDRACK6U <a href="#">760169581</a>
	3 in (76 mm) Channel x 12.9 in (327.66 mm) H - 19 in (482.6 mm) Overhead Patch Panel Rack (6U) 3/8 Sq Punch, with Mini Vertical Cable Management, Black					OVRHRDRACKVCM6U <a href="#">760169599</a>
	Mini Vertical Cable Management for Overhead Patch Panel Rack, 6U, black					OVRHDVCM6U <a href="#">760169607</a>

### Direct System Selection Index

FEC	FACT ODF	UMSC	Flex Frame ODF, 19-in. Propel Panels	FOSC 600	19-in. Splice Solutions	Singlemode Fiber Cables	Singlemode Patch Cord, Cable Mgmt Products	Pre-term 19-in. Fiber	Pre-term FACT ODF Fiber	FiberGuide	Copper Category 6A	Powered Fiber	DIN Rail Solutions	Fiber Wall Boxes	2 Post Equipment Racks	imVision®
-----	----------	------	--------------------------------------	----------	-------------------------	-------------------------	--	-----------------------	-------------------------	------------	--------------------	---------------	--------------------	------------------	------------------------	-----------

### Architecture System Selection Index

#### Colocation Campus and Building Infrastructure

Fiber Entrance, Meet-Me Room	High Fiber Count DC Interconnect	Campus Cabling	Building Cabling	Campus Cabling for Wi-Fi and Security
------------------------------	----------------------------------	----------------	------------------	---------------------------------------

#### Customer Space Cabling Infrastructure

MDA Fiber	EDA Fiber	EDA Copper	FiberGuide Raceway
-----------	-----------	------------	--------------------

#### Reference Designs and Technical Information

MDA Cabinet	MDA Cross-connect 19-in.	MDA Cross-connect FACT ODF	IDF FACT	IDF 19-in.	FEC
-------------	--------------------------	----------------------------	----------	------------	-----



Review Pre-terminated 19-in. Fiber System Selection here.

Fits to:

EPX - LGX/1000 Style

EPX - G2 Style

Evolve Mixed Media

## SYSTIMAX ULL and Propel Pre-Terminated Trunk Cables

12-fiber MPO connector-based modules available in 0 550 OM4 and LazrSPEED OM5 Wideband multimode fiber solutions

12-fiber MPO connector-based modules available in TeraSPEED singlemode fiber solutions

Factory-terminated and tested trunk cables provide superior quality and performance for field connections

Reliable transmit-to-receive connectivity using Method B Enhanced polarity maintenance maximizes administrative convenience

Simplified reconfiguration for moves, adds and changes (MACs)

Easy upgrade path to parallel transmission and associated applications, and increased value of existing infrastructure

SYSTIMAX ULL and Propel trunks are provisioned with pins to interface with G2 and Propel modules (each supplied without pins)



## SYSTIMAX ULL MPO-12 Trunk Cables

1 U	2 G	3 X	4 M	5 X	6 M	7 X	8 A	9 D	10 -	11 M	12 A	13 F	14-16 010		
<b>Construction type</b> U Ultra-Low Loss	<b>Family</b> 3 Trunk, LSZH/Riser, CPR Class B2ca G Trunk, Plenum	<b>Fiber type</b> G TeraSPEED singlemode (A2) X LazrSPEED 550 multimode V LazrSPEED OM5 WB multimode	<b>Termination end A</b> MX MPO (pinned)		<b>Termination end B</b> MX MPO (pinned)		<b>Construction</b> A 12 Fiber PmP	<b>Fiber count</b> D 12-fiber F 24-fiber H 48-fiber K 72-fiber L 96-fiber M 144-fiber		<b>Color</b> M Aqua N Lime green J Yellow  LazrSPEED OM4 standard is aqua LazrSPEED OM5 standard is lime green  TeraSPEED singlemode standard is yellow		<b>Options</b> A No gland B With gland C With pulling eye  Use accessory gland for patch cords in case gland is required on one side only		<b>Unit of measure</b> F Feet M Meter	<b>Length</b> 010-999 Feet 003-305 Meter



Fits to: **Propel**

## Propel MPO-12 Singlemode & Multimode Trunk Cables

1 U	2 G	3 X	4 M	5 X	6 M	7 X	8 C	9 D	10 -	11 M	12 J	13 F	14-16 010		
<b>Construction type</b> U Ultra-low loss	<b>Cable family</b> 3 Trunk, LSZH CPR B2ca G Trunk, Plenum J Trunk, Dual Rated (OFNR/LSZH)	<b>Fiber type</b> G singlemode (A2) X OM4 multimode V OM5 WB multimode	<b>Connector 1</b> MX 12f MPO (Pinned)		<b>Connector 2</b> MX 12f MPO (Pinned)		<b>Cordage size</b> C 12f PmP Trunk, 2.0mm SU	<b>Fiber count</b> D 12-fiber F 24-fiber G 36-fiber H 48-fiber K 72-fiber L 96-fiber M 144-fiber N 192-fiber P 288-fiber		<b>Color</b> M OM4 Aqua N OM5 Lime green J Yellow		<b>Breakout length</b> J 22" Break Propel No Pull Grip K 22" Break Propel Pull Grip		<b>UOM</b> F Feet M Meter	<b>Length</b> 010-999 ft 003-305 m

Note: For MPO-8, MPO-16, and MPO-24 products and other trunk configurations please contact your CommScope sales representative.

### Direct System Selection Index

FEC	FACT ODF	UMSC	Flex Frame ODF, 19-in. Propel Panels	FOSC 600	19-in. Splice Solutions	Singlemode Fiber Cables	Singlemode Patch Cord, Cable Mgmt Products	Pre-term 19-in. Fiber	Pre-term FACT ODF Fiber	FiberGuide	Copper Category 6A	Powered Fiber	DIN Rail Solutions	Fiber Wall Boxes	2 Post Equipment Racks	imVision®
-----	----------	------	--------------------------------------	----------	-------------------------	-------------------------	--	-----------------------	-------------------------	------------	--------------------	---------------	--------------------	------------------	------------------------	-----------

### Architecture System Selection Index

#### Colocation Campus and Building Infrastructure

Fiber Entrance, Meet-Me Room	High Fiber Count DC Interconnect	Campus Cabling	Building Cabling	Campus Cabling for Wi-Fi and Security
------------------------------	----------------------------------	----------------	------------------	---------------------------------------

#### Customer Space Cabling Infrastructure

MDA Fiber	EDA Fiber	EDA Copper	FiberGuide Raceway
-----------	-----------	------------	--------------------

#### Reference Designs and Technical Information

MDA Cabinet	MDA Cross-connect 19-in.	MDA Cross-connect FACT ODF	IDF FACT	IDF 19-in.	FEC
-------------	--------------------------	----------------------------	----------	------------	-----



Review Pre-terminated 19-in. Fiber System Selection here.

All cable assemblies on this page fit to:

EPX - LGX/1000 Style

EPX - G2 Style

Evolve Mixed Media

**SYSTIMAX ULL MPO Array Trunks**

12-fiber MPO connector-based modular design enables simple connections

Array trunks are constructed with 550 OM4 and OM5 Wideband and singlemode fibers

Factory-terminated and tested for instant field connections giving guaranteed quality and performance

MPO-MPO array trunks are constructed with 3.0 mm PmP array cords

**SYSTIMAX ULL MPO/LC Array Cords**

TeraSPEED singlemode or multimode 12 fiber MPO connectors ensure fast and simple connections

Available in LazrSPEED 550 OM4 and LazrSPEED 550 OM5 Wideband multimode fibers

Factory-terminated and tested trunk cables provide superior quality and performance for field connections

Array fanouts available with multiple breakout lengths for simple installation

## SYSTIMAX ULL MPO Array Trunks



1 U	2 Q	3 X	4 M	5 X	6 M	7 X	8 G	9 D	10 -	11 M	12 E	13 F	14-16 010
<b>Construction type</b> U Ultra-Low Loss	<b>Cable family</b> R Array LSZH Q Array Plenum	<b>Fiber type</b> G TeraSPEED singlemode (A2) X LazrSPEED 550 multimode V LazrSPEED OM5 WB multimode	<b>Connector 1</b> MX 12f MPO (pinned)		<b>Connector 2</b> MX 12f MPO (pinned)		<b>Cordage size</b> G 12-fiber PmP Array Cord	<b>Fiber count</b> D 12-fiber	<b>Color</b> M Aqua N Lime green J Yellow	<b>Breakout length</b> D 12 in breakout, no gland E 24 in breakout, no gland H 48 in breakout, no gland L 72 in breakout, no gland P 96 in breakout, no gland A No gland, no breakout		<b>Unit of measure</b> F Feet M Meter	<b>Length minimal length based on breakout</b> 12 in 3-999 ft 24 in 4-999 ft 48 in 6-999 ft 72 in 8-999 ft 96 in 10-999 ft
		*2P, 2X and 2C only available for multimode fiber						LazrSPEED OM4 standard is aqua LazrSPEED OM5 standard is lime green TeraSPEED singlemode standard is yellow				12 in 1-305 m 24-48 in 2-305 m 72 in 3-305 m 96 in 4-305 m  Total length includes the breakout	

## SYSTIMAX ULL MPO/LC Array Cords



1 U	2 N	3 X	4 M	5 P	6 L	7 C	8 G	9 D	10 -	11 M	12 E	13 F	14-16 010
<b>Construction type</b> U Ultra-Low Loss	<b>Cable family</b> R LSZH Array Q Plenum Array	<b>Fiber type</b> G TeraSPEED singlemode (A2) X LazrSPEED 550 multimode V LazrSPEED OM5 WB multimode	<b>Connector 1</b> MP 12f MPO (unpinned)		<b>Connector 2</b> LC LC connector		<b>Cordage size</b> G 12-fiber PmP Array Cord	<b>Fiber count</b> D 12-fiber	<b>Color</b> M Aqua N Lime green J Yellow	<b>Breakout length</b> D 12 in breakout, no gland E 24 in breakout, no gland H 48 in breakout, no gland L 72 in breakout, no gland P 96 in breakout, no gland		<b>Unit of measure</b> F Feet M Meter	<b>Length minimal length based on breakout</b> 12 in 3-999 ft 24 in 4-999 ft 48 in 6-999 ft 72 in 8-999 ft 96 in 10-999 ft
								LazrSPEED OM4 standard is aqua LazrSPEED OM5 standard is lime green TeraSPEED singlemode standard is yellow				12 in 1-305 m 24-48 in 2-305 m 72 in 3-305 m 96 in 4-305 m  Other lengths available	

Note: For MPO-8, MPO-16, and MPO-24 products and other trunk configurations please contact your CommScope sales representative.

### Direct System Selection Index

FEC	FACT ODF	UMSC	Flex Frame ODF, 19-in. Propel Panels	FOSC 600	19-in. Splice Solutions	Singlemode Fiber Cables	Singlemode Patch Cord, Cable Mgmt Products	Pre-term 19-in. Fiber	Pre-term FACT ODF Fiber	FiberGuide	Copper Category 6A	Powered Fiber	DIN Rail Solutions	Fiber Wall Boxes	2 Post Equipment Racks	imVision®
-----	----------	------	--------------------------------------	----------	-------------------------	-------------------------	--	-----------------------	-------------------------	------------	--------------------	---------------	--------------------	------------------	------------------------	-----------

### Architecture System Selection Index

#### Colocation Campus and Building Infrastructure

Fiber Entrance, Meet-Me Room	High Fiber Count DC Interconnect	Campus Cabling	Building Cabling	Campus Cabling for Wi-Fi and Security
------------------------------	----------------------------------	----------------	------------------	---------------------------------------

#### Customer Space Cabling Infrastructure

MDA Fiber	EDA Fiber	EDA Copper	FiberGuide Raceway
-----------	-----------	------------	--------------------

#### Reference Designs and Technical Information

MDA Cabinet	MDA Cross-connect 19-in.	MDA Cross-connect FACT ODF	IDF FACT	IDF 19-in.	FEC
-------------	--------------------------	----------------------------	----------	------------	-----



Review Pre-terminated 19-in. Fiber System Selection [here](#).

All cable assemblies on this page fit to: **Propel**



## Propel MPO-12 Singlemode & Multimode Patch Cords

1 U	2 O	3 X	4 M	5 P	6 M	7 P	8 U	9 D	10 -	11 M	12 A	13 F	14-16 003
<b>Construction type</b> U Ultra-low loss	<b>Cable family</b> Q Plenum Array R Dual Rated (OFNR/LSZH)	<b>Fiber type</b> G Singlemode (A2) X OM4 multimode V OM5 WB multimode	<b>Connector 1</b> MP 12f MPO (Non-pinned)	<b>Connector 2</b> MP 12f MPO (Non-pinned)	<b>Cordage size</b> U 12f PmP Array Cord, 2mm		<b>Fiber count</b> D 12-fiber	<b>Color</b> M OM4 Aqua N OM5 Lime green J Yellow			<b>Breakout length</b> A No gland	<b>UOM</b> F Feet M Meter	<b>Length</b> 010-999 ft 003-305 m



## Propel MPO-12 Singlemode & Multimode Patch Cords

1 U	2 O	3 G	4 M	5 P	6 L	7 U	8 U	9 D	10 -	11 M	12 D	13 F	14-16 003
<b>Construction type</b> U Ultra-low loss	<b>Cable family</b> Q Plenum Array R Dual Rated (OFNR/LSZH)	<b>Fiber type</b> G Singlemode (A2) X OM4 multimode V OM5 WB multimode	<b>Connector 1</b> MP 12f MPO (Non-pinned) MX 12f MPO (Pinned)	<b>Connector 2</b> LU LC Uniboot	<b>Cordage size</b> U 12f PmP Array Cord, 2mm		<b>Fiber count</b> D 12-fiber	<b>Color</b> M OM4 Aqua N OM5 Lime green			<b>Breakout length</b> D 12" E 24" H 48" L 72"	<b>UOM</b> F Feet M Meter	<b>Length</b> 12 in 3-999 ft 24 in 4-999 ft 48 in 6-999 ft 72 in 8-999 ft 12 in 1-305 m 24-48 in 2-305 m 72 in 3-305 m

Note: For MPO-8, MPO-16, and MPO-24 products and other trunk configurations please contact your CommScope sales representative.

### Direct System Selection Index

FEC	FACT ODF	UMSC	Flex Frame ODF, 19-in. Propel Panels	FOSC 600	19-in. Splice Solutions	Singlemode Fiber Cables	Singlemode Patch Cord, Cable Mgmt Products	Pre-term 19-in. Fiber	Pre-term FACT ODF Fiber	FiberGuide	Copper Category 6A	Powered Fiber	DIN Rail Solutions	Fiber Wall Boxes	2 Post Equipment Racks	imVision®
-----	----------	------	--------------------------------------	----------	-------------------------	-------------------------	--	-----------------------	-------------------------	------------	--------------------	---------------	--------------------	------------------	------------------------	-----------

### Architecture System Selection Index

#### Colocation Campus and Building Infrastructure

Fiber Entrance, Meet-Me Room	High Fiber Count DC Interconnect	Campus Cabling	Building Cabling	Campus Cabling for Wi-Fi and Security
------------------------------	----------------------------------	----------------	------------------	---------------------------------------

#### Customer Space Cabling Infrastructure

MDA Fiber	EDA Fiber	EDA Copper	FiberGuide Raceway
-----------	-----------	------------	--------------------

#### Reference Designs and Technical Information

MDA Cabinet	MDA Cross-connect 19-in.	MDA Cross-connect FACT ODF	IDF FACT	IDF 19-in.	FEC
-------------	--------------------------	----------------------------	----------	------------	-----



[Review Pre-terminated 19-in. Fiber System Selection here.](#)

All cable assemblies on this page fit to:

EPX - LGX/1000 Style

EPX - G2 Style

Evolve Mixed Media



## SYSTIMAX ULL LC-LC Pre-terminated Array Trunks

LC/LC trunks, 24 f	Patch Cord Type	Jacket Material	Fiber Type	Description Code	Part Number
LC/LC Microdistribution-cable, 12 x LC Duplex uniboot on each side, flexible cable construction, OD 3 mm	N/A	LSZH/Riser	OM4	URXLULUHF	URXLULUHF
LC/LC Microdistribution-cable, 12 x LC Duplex uniboot on each side, flexible cable construction, OD 3 mm	N/A	LSZH/Riser	OM5	URVLULUHF	URVLULUHF
LC/LC Microdistribution-cable, 12 x LC Duplex uniboot on each side, flexible cable construction, OD 3 mm	N/A	LSZH/Riser	OS2	FRWLULUHF	FRWLULUHF

## SYSTIMAX ULL Patch Cords

Patch Cords	Patch Cord Type	Application	Fiber Type	Description Code	Part Number
Ultra Low Loss (ULL) LazrSPEED 550 OM4 LC Uniboot to LC Uniboot, Fiber Patch Cord, 1.5 mm Duplex, LSZH/Riser	LC-D to LC-D, 1.5 mm diameter, LSZH/Riser	Distribution/XC	OM4	UFXLULUK2	<a href="#">UFXLULUK2</a>
Ultra Low Loss (ULL) LazrSPEED 550 WideBand OM5 LC Uniboot to LC Uniboot, Fiber Patch Cord, 1.5 mm Duplex, LSZH/Riser	LC-D to LC-D, 1.5 mm diameter, LSZH/Riser	Distribution/XC	OM5	UFVLULUK2	<a href="#">UFVLULUK2</a>
Ultra Low Loss (ULL) TeraSPEED LC Uniboot to LC Uniboot, Fiber Patch Cord, 1.5 mm Duplex, LSZH/Riser	LC-D to LC-D, 1.5 mm diameter, LSZH/Riser	Distribution/XC	OS2	UFGLULUK2	<a href="#">UFGLULUK2</a>
Ultra Low Loss (ULL) LazrSPEED 550 OM4 LC Uniboot to LC Uniboot, Fiber Patch Cord, 2.0 mm Duplex, LSZH/Riser	LC-D to LC-D, 2 mm diameter, LSZH/Riser	Equipment Area	OM4	UFXLULU62	<a href="#">UFXLULU62</a>
Ultra Low Loss (ULL) LazrSPEED 550 WideBand OM5 LC Uniboot to LC Uniboot, Fiber Patch Cord, 2.0 mm Duplex, LSZH/Riser	LC-D to LC-D, 2 mm diameter, LSZH/Riser	Equipment Area	OM5	UFVLULU62	<a href="#">UFVLULU62</a>
Ultra Low Loss (ULL) TeraSPEED LC Uniboot to LC Uniboot, Fiber Patch Cord, 2.0 mm Duplex, LSZH/Riser	LC-D to LC-D, 2 mm diameter, LSZH/Riser	Equipment Area	OS2	UFGLULU62	<a href="#">UFGLULU62</a>
Ultra Low Loss (ULL) LazrSPEED 550 OM4 MPO/8 (Unpinned) to MPO/8 (Unpinned), 8-Fiber, LSZH/Riser	MPO-MPO, unpinned, 8 fibers, LSZH/Riser	Distribution or Equipment Area	OM4	URXQPQPJ8	<a href="#">URXQPQPJ8</a>
Ultra Low Loss (ULL) LazrSPEED 550 WideBand OM5 MPO/8 (Unpinned) to MPO/8 (Unpinned), 8-Fiber, LSZH/Riser	MPO-MPO, unpinned, 8 fibers, LSZH/Riser	Distribution or Equipment Area	OM5	URVQPQPJ8	<a href="#">URVQPQPJ8</a>
Ultra Low Loss (ULL) TeraSPEED MPO/8 (Unpinned) to MPO/8 (Unpinned), 8-Fiber, LSZH/Riser	MPO-MPO, unpinned, 8 fibers, LSZH/Riser	Distribution or Equipment Area	OS2	URGQPQPJ8	<a href="#">URGQPQPJ8</a>

Fiber Cleaning	Part Number
Fiber Optic MTP/MPO One Slot Reel Cleaner	<a href="#">1918802-1</a>
One slot reel cleaner for 1.25 mm and 2.5 mm ferrule connectors, MPO/MTP without pins (female), and MT-RJ without pins (female)	<a href="#">1918803-1</a>
Fiber Optic MTP/MPO IBC (In Bulkhead Cleaner)	<a href="#">1918809-1</a>
Fiber Optic SC IBC (In Bulkhead Cleaner)	<a href="#">2064499-1</a>
Fiber Optic LC IBC (In Bulkhead Cleaner)	<a href="#">2064500-1</a>
Cleaning and Inspection Kit, Fiber Optic	<a href="#">760053199</a>
Cleaning Consumables Kit, Fiber Optic	<a href="#">760053207</a>



Fiber Optic Cleaning and Inspection Kit

### Direct System Selection Index

FEC	FACT ODF	UMSC	Flex Frame ODF, 19-in. Propel Panels	FOSC 600	19-in. Splice Solutions	Singlemode Fiber Cables	Singlemode Patch Cord, Cable Mgmt Products	Pre-term 19-in. Fiber	Pre-term FACT ODF Fiber	FiberGuide	Copper Category 6A	Powered Fiber	DIN Rail Solutions	Fiber Wall Boxes	2 Post Equipment Racks	imVision®
-----	----------	------	--------------------------------------	----------	-------------------------	-------------------------	--	-----------------------	-------------------------	------------	--------------------	---------------	--------------------	------------------	------------------------	-----------

### Architecture System Selection Index

#### Colocation Campus and Building Infrastructure

Fiber Entrance, Meet-Me Room	High Fiber Count DC Interconnect	Campus Cabling	Building Cabling	Campus Cabling for Wi-Fi and Security
------------------------------	----------------------------------	----------------	------------------	---------------------------------------

#### Customer Space Cabling Infrastructure

MDA Fiber	EDA Fiber	EDA Copper	FiberGuide Raceway
-----------	-----------	------------	--------------------

#### Reference Designs and Technical Information

MDA Cabinet	MDA Cross-connect 19-in.	MDA Cross-connect FACT ODF	IDF FACT	IDF 19-in.	FEC
-------------	--------------------------	----------------------------	----------	------------	-----



## FACT-FACT Pre-Term

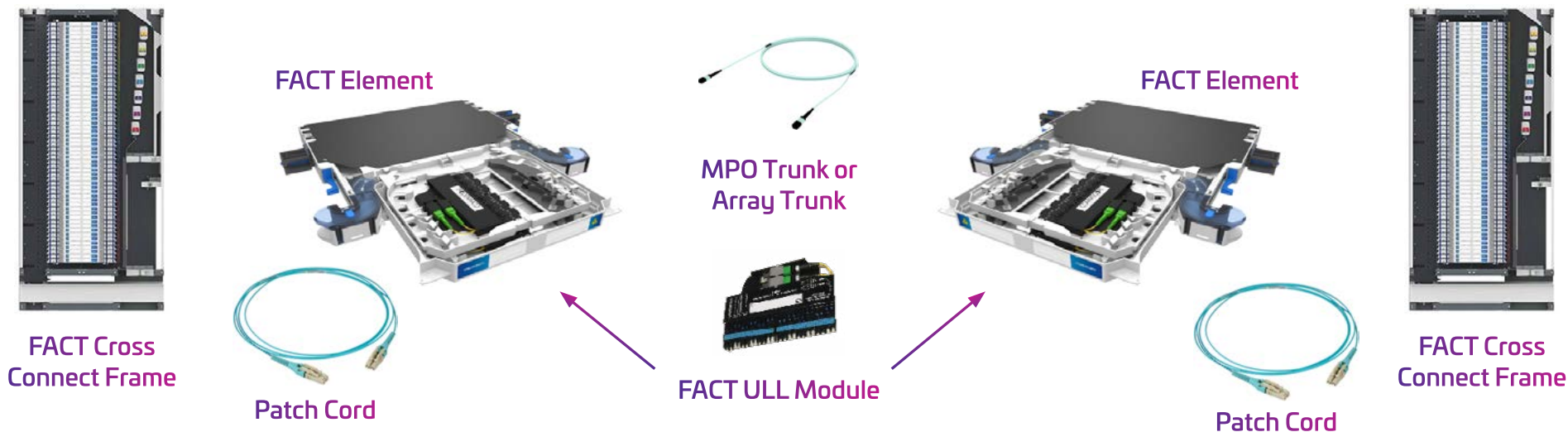

## FACT-Panel Pre-Term

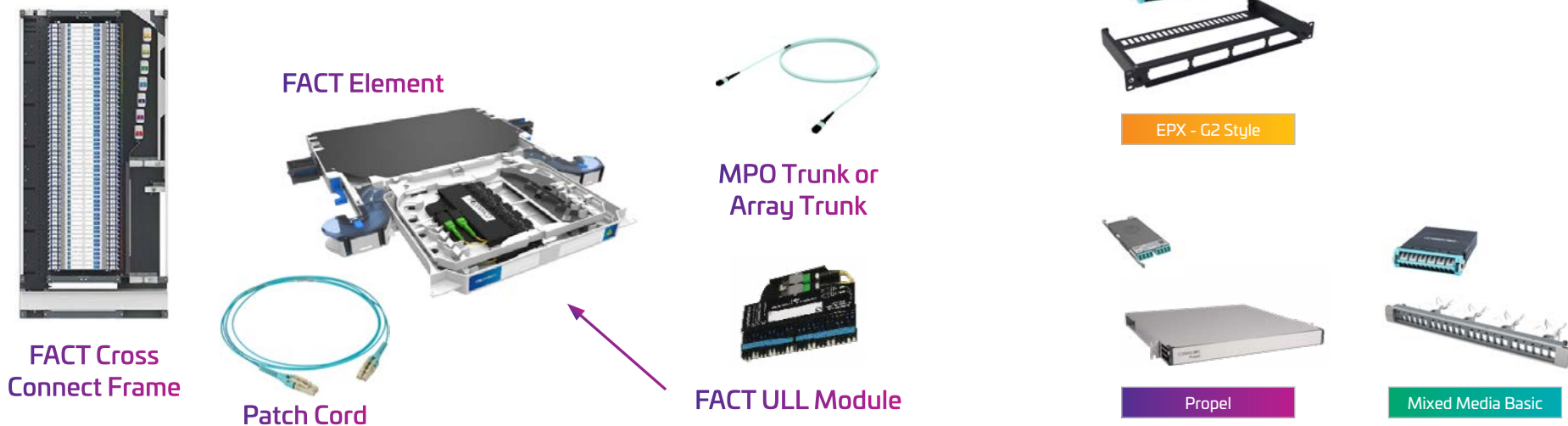

### Direct System Selection Index

FEC	FACT ODF	UMSC	Flex Frame ODF, 19-in. Propel Panels	FOSC 600	19-in. Splice Solutions	Singlemode Fiber Cables	Singlemode Patch Cord, Cable Mgmt Products	Pre-term 19-in. Fiber	Pre-term FACT ODF Fiber	FiberGuide	Copper Category 6A	Powered Fiber	DIN Rail Solutions	Fiber Wall Boxes	2 Post Equipment Racks	imVision®
-----	----------	------	--------------------------------------	----------	-------------------------	-------------------------	--	-----------------------	-------------------------	------------	--------------------	---------------	--------------------	------------------	------------------------	-----------

### Architecture System Selection Index

#### Colocation Campus and Building Infrastructure

Fiber Entrance, Meet-Me Room	High Fiber Count DC Interconnect	Campus Cabling	Building Cabling	Campus Cabling for Wi-Fi and Security
------------------------------	----------------------------------	----------------	------------------	---------------------------------------

#### Customer Space Cabling Infrastructure

MDA Fiber	EDA Fiber	EDA Copper	FiberGuide Raceway
-----------	-----------	------------	--------------------

#### Reference Designs and Technical Information

MDA Cabinet	MDA Cross-connect 19-in.	MDA Cross-connect FACT ODF	IDF FACT	IDF 19-in.	FEC
-------------	--------------------------	----------------------------	----------	------------	-----



Review Pre-terminated FACT ODF Fiber System Selection here.

FACT Frame		Description Code	Part Number		
FACT Cross Connect frame, patching on the right		FACT-FRCCRHP22	760243095		
FACT Cross Connect frame, patching on the Left		FACT-FRCLHP22	760243094		
FACT patch cord overlength management bay		FACT-FROLB22	760243097		
FACT Interconnect Frame – Right Hand Patch (2.2m)		FACT-FRICRHP22	760243096		
FACT Frame Accessories		Description Code	Part Number		
FACT Cross Connect door kit. Set of two doors with two door handles per door (one set per frame)		FACT-FRCCD22	760243098		
FACT Cross Connect side panel kit (pack of two side panels)		FACT-FRCCP22	760243099		
FACT Patch Cord Overlength Bay Door (2.2m)		FACT-FROLBD22	760243101		
FACT Interconnect Frame door kit		FACT-FRICD22	760243100		
FACT Fiber guide fixation kit		FACT-FRACCFGFS	760243110		
FACT-FRACCCAPL One cable attachment plate with one cable to flex conversion bracket included.		FACT-FRACCCAPL	760243108		
FACT-FRACCCTF One cable to flex conversion component set for cable attachment plate (one cable to flex component per cable)		FACT-FRACCCTF	760243111		
FACT-FRACCFOPL One fan out fixation plate for frame side duct & Eight fan out fixation component sets		FACT-FRACCFOPL	760243109		
Eight fan out fixation component sets (for fan out fixation plate) FACT		FACT-FRACCFOFK-8	760243112		
FACT Patch-Patch Elements and FACT NG4 Elements	Element Type	Fiber Count	Fiber Type	Description Code	Part Number
FACT Fiber Optic Patch Panel, blue, 6E high, 288-port simplex, multimode, OM4, holding 10 hinged trays loaded with LC/UPC adapters	Patch/Patch	288	OM4	FACT-6EPATL4	760240442
FACT Fiber Optic Patch Panel, blue, 6E high, 288-port simplex, singlemode, holding 10 hinged trays loaded with LC/UPC adapters	Patch/Patch	288	OS2	FACT-6EPATL1	760240441
FACT Fiber Optic Patch Panel, blue, 4E high, 192-port simplex, multimode, OM4, holding 8 hinged trays loaded with LC/UPC adapters	Patch/Patch	192	OM4	FACT-4EPATL4	760239995
FACT Fiber Optic Patch Panel, blue, 4E high, 192-port simplex, singlemode, holding 8 hinged trays loaded with LC/UPC adapters	Patch/Patch	192	OS2	FACT-4EPATL1	760239993
FACT Fiber Optic Patch Panel, blue, 3E high, 144-port simplex, multimode, OM4, holding 6 hinged trays loaded with LC/UPC adapters	Patch/Patch	144	OM4	FACT-3EPATL4	760239990
FACT Fiber Optic Patch Panel, blue, 3E high, 144-port simplex, singlemode, holding 6 hinged trays loaded with LC/UPC adapters	Patch/Patch	144	OS2	FACT-3EPATL1	760239988
FACT Fiber Optic Patch Panel, blue, 2E high, 96-port simplex, multimode, OM4, holding 4 hinged trays loaded with LC/UPC adapters	Patch/Patch	96	OM4	FACT-2EPATL4	760239984
FACT Fiber Optic Patch Panel, blue, 2E high, 96-port simplex, singlemode, holding 4 hinged trays loaded with LC/UPC adapters	Patch/Patch	96	OS2	FACT-2EPATL1	760239982
FACT Fiber Optic Patch Panel, blue, 1E high, 48-port simplex, multimode, OM4, holding 2 hinged trays loaded with LC/UPC adapters	Patch/Patch	48	OM4	FACT-1EPATL4	760240416
FACT Fiber Optic Patch Panel, blue, 1E high, 48-port simplex, singlemode, holding 2 hinged trays loaded with LC/UPC adapters	Patch/Patch	48	OS2	FACT-1EPATL1	760240414
FACT NG4 Fiber Panel, with 12 unloaded trays, blue, 6E high, for holding 12 NG4 MPO modules	NG4 Module	288	Universal	FACT-6ENG4	760242087
FACT NG4 Fiber Panel, with 8 unloaded trays, blue, 4E high, for holding 8 NG4 MPO modules	NG4 Module	192	Universal	FACT-4ENG4	760239978
FACT NG4 Fiber Panel, with 6 unloaded trays, blue, 3E high, for holding 6 NG4 MPO modules	NG4 Module	144	Universal	FACT-3ENG4	760239977
FACT NG4 Fiber Panel, with 4 unloaded trays, blue, 2E high, for holding 4 NG4 MPO modules	NG4 Module	96	Universal	FACT-2ENG4	760239976
FACT NG4 Fiber Panel, with 2 unloaded trays, blue, 1E high, for holding 2 NG4 MPO modules	NG4 Module	48	Universal	FACT-1ENG4	760239975
FACT NG4 Module	Cable Entrance	Fiber Type	Description Code		
FACT left sided ULL module, MPO24f to 12x LC-D, OM4	Left	OM4	FACT-MMDLC2-B		
FACT right sided ULL module, MPO24f to 12x LC-D, OM4	Right	OM4	FACT-MMDRC2-B		
FACT left sided ULL module, MPO24f to 12x LC-D, OM5	Left	OM5	FACT-MMDL52-B		
FACT right sided ULL module, MPO24f to 12x LC-D, OM5	Right	OM5	FACT-MMDR52-B		
FACT left sided ULL module, 2 x MPO12f to 12x LC-D, OS2	Left	OS2	FACT-MMDLKE-B		
FACT right sided ULL module, 2 x MPO12f to 12x LC-D, OS2	Right	OS2	FACT-MMDRKE-B		

## Direct System Selection Index

FEC	FACT ODF	UMSC	Flex Frame ODF, 19-in. Propel Panels	FOSC 600	19-in. Splice Solutions	Singlemode Fiber Cables	Singlemode Patch Cord, Cable Mgmt Products	Pre-term 19-in. Fiber	Pre-term FACT ODF Fiber	FiberGuide	Copper Category 6A	Powered Fiber	DIN Rail Solutions	Fiber Wall Boxes	2 Post Equipment Racks	imVision®
-----	----------	------	--------------------------------------	----------	-------------------------	-------------------------	--	-----------------------	-------------------------	------------	--------------------	---------------	--------------------	------------------	------------------------	-----------

## Architecture System Selection Index

### Colocation Campus and Building Infrastructure

Fiber Entrance, Meet-Me Room	High Fiber Count DC Interconnect	Campus Cabling	Building Cabling	Campus Cabling for Wi-Fi and Security
------------------------------	----------------------------------	----------------	------------------	---------------------------------------

### Customer Space Cabling Infrastructure

MDA Fiber	EDA Fiber	EDA Copper	FiberGuide Raceway
-----------	-----------	------------	--------------------

### Reference Designs and Technical Information

MDA Cabinet	MDA Cross-connect 19-in.	MDA Cross-connect FACT ODF	IDF FACT	IDF 19-in.	FEC
-------------	--------------------------	----------------------------	----------	------------	-----





Review Pre-terminated FACT ODF Fiber System Selection here.

All cable assemblies on this page fit to:

FACT-FACT Pre-Term

FACT-Panel Pre-Term



## SYSTIMAX ULL MPO-12 Trunk Cables

<b>SYSTIMAX ULL Pre-terminated Trunk Cables</b>
12-fiber MPO connector-based modules available in LazrSPEED 550 OM4 and LazrSPEED OM5 Wideband multimode fiber solutions
12-fiber MPO connector-based modules available in TeraSPEED singlemode fiber solutions
Factory-terminated and tested trunk cables provide superior quality and performance for field connections
Reliable transmit-to-receive connectivity using Method B Enhanced polarity maintenance maximizes administrative convenience
Simplified reconfiguration for moves, adds and changes (MACs)
Easy upgrade path to parallel transmission and associated applications, and increased value of existing infrastructure
SYSTIMAX ULL trunks are provisioned with pins to interface with G2 and EHD ULL modules (without pins)

1 U	2 G	3 X	4 M	5 X	6 M	7 X	8 A	9 K	10 -	11 M	12 A	13 F	14-16 010	
<b>Construction type</b> U Ultra-Low Loss	<b>Family</b> 3 Trunk, LSZH/Riser, CPR Class B2ca G Trunk, Plenum	<b>Fiber type</b> G TeraSPEED singlemode (A2) X LazrSPEED 550 multimode V LazrSPEED OM5 WB multimode	<b>Termination end A</b> MX MPO (pinned)		<b>Termination end B</b> MX MPO (pinned)		<b>Construction A</b> 12 Fiber PmP	<b>Fiber count</b> D 12-fiber F 24-fiber H 48-fiber K 72-fiber L 96-fiber M 144-fiber			<b>Color</b> M Aqua N Lime green J Yellow  LazrSPEED OM4 standard is aqua LazrSPEED OM5 standard is lime green TeraSPEED singlemode standard is yellow	<b>Options</b> W No gland, 60-in. breakout  Use accessory gland for patch cords in case gland is required on one side only	<b>Unit of measure</b> F Feet M Meter	<b>Length</b> 010-999 Feet 003-305 Meter

Note: for MPO-8 products and other trunk configurations please contact your CommScope sales representative.

### Direct System Selection Index

FEC	FACT ODF	UMSC	Flex Frame ODF, 19-in. Propel Panels	FOSC 600	19-in. Splice Solutions	Singlemode Fiber Cables	Singlemode Patch Cord, Cable Mgmt Products	Pre-term 19-in. Fiber	Pre-term FACT ODF Fiber	FiberGuide	Copper Category 6A	Powered Fiber	DIN Rail Solutions	Fiber Wall Boxes	2 Post Equipment Racks	imVision®
-----	----------	------	--------------------------------------	----------	-------------------------	-------------------------	--	-----------------------	-------------------------	------------	--------------------	---------------	--------------------	------------------	------------------------	-----------

### Architecture System Selection Index

#### Colocation Campus and Building Infrastructure

Fiber Entrance, Meet-Me Room	High Fiber Count DC Interconnect	Campus Cabling	Building Cabling	Campus Cabling for Wi-Fi and Security
------------------------------	----------------------------------	----------------	------------------	---------------------------------------

#### Customer Space Cabling Infrastructure

MDA Fiber	EDA Fiber	EDA Copper	FiberGuide Raceway
-----------	-----------	------------	--------------------

#### Reference Designs and Technical Information

MDA Cabinet	MDA Cross-connect 19-in.	MDA Cross-connect FACT ODF	IDF FACT	IDF 19-in.	FEC
-------------	--------------------------	----------------------------	----------	------------	-----



Review Pre-terminated FACT ODF Fiber System Selection here.

All cable assemblies on this page fit to:

FACT-FACT Pre-Term

FACT-Panel Pre-Term



SYSTIMAX ULL MPO Array Cords

**SYSTIMAX ULL MPO Array Cords**

12-fiber MPO connector-based modular design enables simple connections

Array cords are constructed with 550 OM4 and OM5 Wideband and singlemode fibers

Factory-terminated and tested for instant field connections giving guaranteed quality and performance

MPO-MPO arrays are constructed with 3.0 mm PmP array cords

1 U	2 Q	3 X	4 M	5 X	6 M	7 X	8 G	9 D	10 -	11 M	12 E	13 F	14-16 010
<b>Construction type</b> U Ultra-Low Loss	<b>Cable family</b> Q Array, Plenum	<b>Fiber type</b> G TeraSPEED singlemode (A2) X LazrSPEED 550 multimode V LazrSPEED OM5 WB multimode	<b>Connector 1</b> MX 12f MPO (pinned)	<b>Connector 2</b> MX 12f MPO (pinned)	<b>Cordage size</b> G 12-fiber PmP Array Cord	<b>Fiber count</b> D 12-fiber	<b>Color</b> M Aqua N Lime green J Yellow  LazrSPEED OM4 standard is aqua  LazrSPEED OM5 standard is lime green  TeraSPEED singlemode standard is yellow	<b>Breakout length</b> D 12 in breakout, no gland E 24 in breakout, no gland H 48 in breakout, no gland L 72 in breakout, no gland P 96 in breakout, no gland A No gland, no breakout	<b>Unit of measure</b> F Feet M Meter	<b>Length minimal length based on breakout</b> 12 in 3-999 ft 24 in 4-999 ft 48 in 6-999 ft 72 in 8-999 ft 96 in 10-999 ft  12 in 1-305 m 24-48 in 2-305 m 72 in 3-305 m 96 in 4-305 m  Total length includes the breakout			

Note: for MPO-8 products and other trunk configurations please contact your CommScope sales representative.

Direct System Selection Index

FEC	FACT ODF	UMSC	Flex Frame ODF, 19-in. Propel Panels	FOSC 600	19-in. Splice Solutions	Singlemode Fiber Cables	Singlemode Patch Cord, Cable Mgmt Products	Pre-term 19-in. Fiber	Pre-term FACT ODF Fiber	FiberGuide	Copper Category 6A	Powered Fiber	DIN Rail Solutions	Fiber Wall Boxes	2 Post Equipment Racks	imVision®
-----	----------	------	--------------------------------------	----------	-------------------------	-------------------------	--	-----------------------	-------------------------	------------	--------------------	---------------	--------------------	------------------	------------------------	-----------

Architecture System Selection Index

Colocation Campus and Building Infrastructure

Fiber Entrance, Meet-Me Room	High Fiber Count DC Interconnect	Campus Cabling	Building Cabling	Campus Cabling for Wi-Fi and Security
------------------------------	----------------------------------	----------------	------------------	---------------------------------------

Customer Space Cabling Infrastructure

MDA Fiber	EDA Fiber	EDA Copper	FiberGuide Raceway
-----------	-----------	------------	--------------------

Reference Designs and Technical Information

MDA Cabinet	MDA Cross-connect 19-in.	MDA Cross-connect FACT ODF	IDF FACT	IDF 19-in.	FEC
-------------	--------------------------	----------------------------	----------	------------	-----



Review Pre-terminated FACT ODF Fiber System Selection here.



**SYSTIMAX ULL LC-LC Pre-terminated Array Cords**

LC/LC trunks, 24 f	Patch Cord Type	Jacket Material	Fiber Type	Description Code	Part Number
LC/LC Microdistribution-cable, 12 x LC Duplex uniboot on each side, flexible cable construction, OD 3 mm	N/A	Plenum	OM4	UQXLULUHF	UQXLULUHF
LC/LC Microdistribution-cable, 12 x LC Duplex uniboot on each side, flexible cable construction, OD 3 mm	N/A	Plenum	OM5	UQVLULUHF	UQVLULUHF
LC/LC Microdistribution-cable, 12 x LC Duplex uniboot on each side, flexible cable construction, OD 3 mm	N/A	Plenum	OS2	FQWLULUHF	FRWLULUHF

**SYSTIMAX ULL Patch Cords**

Patch Cords	Patch Cord Type	Application	Fiber Type	Description Code	Part Number
Ultra Low Loss (ULL) LazrSPEED 550 OM4 LC Uniboot to LC Uniboot, Fiber Patch Cord, 1.5 mm Duplex, Plenum	LC-D to LC-D, 1.5 mm diameter, Plenum	Distribution/XC	OM4	UDXLULUK2	<a href="#">UDXLULUK2</a>
Ultra Low Loss (ULL) LazrSPEED 550 WideBand OM5 LC Uniboot to LC Uniboot, Fiber Patch Cord, 1.5 mm Duplex, Plenum	LC-D to LC-D, 1.5 mm diameter, Plenum	Distribution/XC	OM5	UDVLULUK2	<a href="#">UDVLULUK2</a>
Ultra Low Loss (ULL) TeraSPEED LC Uniboot to LC Uniboot, Fiber Patch Cord, 1.5 mm Duplex, Plenum	LC-D to LC-D, 1.5 mm, diameter, Plenum	Distribution/XC	OS2	UDGLLULUK2	<a href="#">UDGLLULUK2</a>
Ultra Low Loss (ULL) LazrSPEED 550 OM4 LC Uniboot to LC Uniboot, Fiber Patch Cord, 2.0 mm Duplex, Plenum	LC-D to LC-D, 2 mm, diameter, Plenum	Equipment Area	OM4	UDXLULU62	<a href="#">UDXLULU62</a>
Ultra Low Loss (ULL) LazrSPEED 550 WideBand OM5 LC Uniboot to LC Uniboot, Fiber Patch Cord, 2.0 mm Duplex, Plenum	LC-D to LC-D, 2 mm	Equipment Area	OM5	UDVLULU62	<a href="#">UDVLULU62</a>
Ultra Low Loss (ULL) TeraSPEED LC Uniboot to LC Uniboot, Fiber Patch Cord, 2.0 mm Duplex, Plenum	LC-D to LC-D, 2 mm, diameter, Plenum	Equipment Area	OS2	UDGLLULU62	<a href="#">UDGLLULU62</a>
Ultra Low Loss (ULL) LazrSPEED 550 OM4 MPO/8 (Unpinned) to MPO/8 (Unpinned), 8-Fiber, Plenum	MPO-MPO, unpinned, 8 fibers, Plenum	Distribution or Equipment Area	OM4	UQXQPQPJ8	<a href="#">UQXQPQPJ8</a>
Ultra Low Loss (ULL) LazrSPEED 550 WideBand OM5 MPO/8 (Unpinned) to MPO/8 (Unpinned), 8-Fiber, Plenum	MPO-MPO, unpinned, 8 fibers, Plenum	Distribution or Equipment Area	OM5	UQVQPQPJ8	<a href="#">UQVQPQPJ8</a>
Ultra Low Loss (ULL) TeraSPEED MPO/8 (Unpinned) to MPO/8 (Unpinned), 8-Fiber, Plenum	MPO-MPO, unpinned, 8 fibers, Plenum	Distribution or Equipment Area	OS2	UQGQPQPJ8	<a href="#">UQGQPQPJ8</a>

**Direct System Selection Index**

FEC	FACT ODF	UMSC	Flex Frame ODF, 19-in. Propel Panels	FOSC 600	19-in. Splice Solutions	Singlemode Fiber Cables	Singlemode Patch Cord, Cable Mgmt Products	Pre-term 19-in. Fiber	Pre-term FACT ODF Fiber	FiberGuide	Copper Category 6A	Powered Fiber	DIN Rail Solutions	Fiber Wall Boxes	2 Post Equipment Racks	imVision®
-----	----------	------	--------------------------------------	----------	-------------------------	-------------------------	--	-----------------------	-------------------------	------------	--------------------	---------------	--------------------	------------------	------------------------	-----------

**Architecture System Selection Index**

**Colocation Campus and Building Infrastructure**

Fiber Entrance, Meet-Me Room	High Fiber Count DC Interconnect	Campus Cabling	Building Cabling	Campus Cabling for Wi-Fi and Security
------------------------------	----------------------------------	----------------	------------------	---------------------------------------

**Customer Space Cabling Infrastructure**

MDA Fiber	EDA Fiber	EDA Copper	FiberGuide Raceway
-----------	-----------	------------	--------------------

**Reference Designs and Technical Information**

MDA Cabinet	MDA Cross-connect 19-in.	MDA Cross-connect FACT ODF	IDF FACT	IDF 19-in.	FEC
-------------	--------------------------	----------------------------	----------	------------	-----



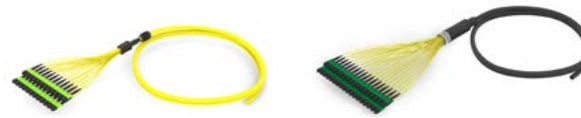

Indoor/Outdoor Armored Rollabe Ribbon - Single-Ended Preterminated Trunk Cable	Fibers	Connector	Polarity Method	Jacket Material	Outer Diameter	Description Code	Part Number
Ultra Low Loss Singlemode MPO12 (Pinned) to Unconnectorized Pre-terminated Trunk Cable Central Tube	864	MPO-12/APC (Pinned/Male)	Method B Enhanced	Riser/Dual Rated	1.106 in. (28.1 mm)		<a href="#">UKGMXUCSX</a>
Ultra Low Loss Singlemode MPO12 (Pinned) to Unconnectorized Pre-terminated Trunk Cable Central Tube	576	MPO-12/APC (Pinned/Male)	Method B Enhanced	Riser/Dual Rated	1.004 in. (25.5 mm)		<a href="#">UKGMXUCSW</a>
Ultra Low Loss Singlemode MPO12 (Pinned) to Unconnectorized Pre-terminated Trunk Cable Central Tube	432	MPO-12/APC (Pinned/Male)	Method B Enhanced	Riser/Dual Rated	0.957 in. (24.3 mm)		<a href="#">UKGMXUCSV</a>
Ultra Low Loss Singlemode MPO12 (Pinned) to Unconnectorized Pre-terminated Trunk Cable Central Tube	288	MPO-12/APC (Pinned/Male)	Method B Enhanced	Riser/Dual Rated	0.807 in. (20.5 mm)		<a href="#">UKGMXUCSP</a>
Ultra Low Loss Singlemode MPO12 (Pinned) to Unconnectorized Pre-terminated Trunk Cable Central Tube	144	MPO-12/APC (Pinned/Male)	Method B Enhanced	Riser/Dual Rated	0.756 in. (19.2 mm)		<a href="#">UKGMXUCSM</a>
Indoor/Outdoor Rollabe Ribbon - Single-Ended Preterminated Trunk Cable	Fibers	Connector	Polarity Method	Jacket Material	Outer Diameter	Description Code	Part Number
Ultra Low Loss Singlemode MPO (Pinned) to Unconnectorized Pre-terminated Trunk Cable, Central Tube	864	MPO-12/APC (Pinned/Male)	Method B Enhanced	Riser/Dual Rated	0.768 in. (19.5 mm)		<a href="#">UJGMXUCSX</a>
Ultra Low Loss Singlemode MPO (Pinned) to Unconnectorized Pre-terminated Trunk Cable, Central Tube	576	MPO-12/APC (Pinned/Male)	Method B Enhanced	Riser/Dual Rated	0.669 in. (17 mm)		<a href="#">UJGMXUCSW</a>
Ultra Low Loss Singlemode MPO (Pinned) to Unconnectorized Pre-terminated Trunk Cable, Central Tube	432	MPO-12/APC (Pinned/Male)	Method B Enhanced	Riser/Dual Rated	0.61 in. (15.5 mm)		<a href="#">UJGMXUCSV</a>
Ultra Low Loss Singlemode MPO (Pinned) to Unconnectorized Pre-terminated Trunk Cable, Central Tube	288	MPO-12/APC (Pinned/Male)	Method B Enhanced	Riser/Dual Rated	0.492 in. (12.5 mm)		<a href="#">UJGMXUCSP</a>
Ultra Low Loss Singlemode MPO (Pinned) to Unconnectorized Pre-terminated Trunk Cable, Central Tube	144	MPO-12/APC (Pinned/Male)	Method B Enhanced	Riser/Dual Rated	0.413 in. (10.5 mm)		<a href="#">UJGMXUCSM</a>
Indoor Rollabe Ribbon - Single-Ended Preterminated Trunk Cable	Fibers	Connector	Polarity Method	Jacket Material	Outer Diameter	Description Code	Part Number
Ultra Low Loss (ULL) Singlemode, MPO (Pinned) to Unconnectorized, Central Tube	288	MPO-12/APC (Pinned/Male)	Method B Enhanced	Plenum	0.476 in. (12.1 mm)		<a href="#">UGGMXUCRP</a>
Ultra Low Loss (ULL) Singlemode, MPO (Pinned) to Unconnectorized, Central Tube	144	MPO-12/APC (Pinned/Male)	Method B Enhanced	Plenum	0.378 in. (9.6 mm)		<a href="#">UGGMXUCRM</a>
Ultra Low Loss ULL TeraSPEED® MPO (Pinned) to Unconnectorized Pre-terminated Trunk Cable	48	MPO-12/APC (Pinned/Male)	Method B Enhanced	Plenum	0.079 in. (2.0 mm)		<a href="#">UGGMXUCRH</a>
Ultra Low Loss ULL TeraSPEED MPO (Pinned) to Unconnectorized Pre-terminated Trunk Cable	24	MPO-12/APC (Pinned/Male)	Method B Enhanced	Plenum	0.079 in. (2.0 mm)		<a href="#">UGGMXUCRF</a>
Ultra Low Loss ULL TeraSPEED MPO (Pinned) to Unconnectorized Pre-terminated Trunk Cable	12	MPO-12/APC (Pinned/Male)	Method B Enhanced	Plenum	0.079 in. (2.0 mm)		<a href="#">UGGMXUCRD</a>

## Direct System Selection Index

FEC	FACT ODF	UMSC	Flex Frame ODF, 19-in. Propel Panels	FOSC 600	19-in. Splice Solutions	Singlemode Fiber Cables	Singlemode Patch Cord, Cable Mgmt Products	Pre-term 19-in. Fiber	Pre-term FACT ODF Fiber	FiberGuide	Copper Category 6A	Powered Fiber	DIN Rail Solutions	Fiber Wall Boxes	2 Post Equipment Racks	imVision®
-----	----------	------	--------------------------------------	----------	-------------------------	-------------------------	--	-----------------------	-------------------------	------------	--------------------	---------------	--------------------	------------------	------------------------	-----------

## Architecture System Selection Index

### Colocation Campus and Building Infrastructure

Fiber Entrance, Meet-Me Room	High Fiber Count DC Interconnect	Campus Cabling	Building Cabling	Campus Cabling for Wi-Fi and Security
------------------------------	----------------------------------	----------------	------------------	---------------------------------------

### Customer Space Cabling Infrastructure

MDA Fiber	EDA Fiber	EDA Copper	FiberGuide Raceway
-----------	-----------	------------	--------------------

### Reference Designs and Technical Information

MDA Cabinet	MDA Cross-connect 19-in.	MDA Cross-connect FACT ODF	IDF FACT	IDF 19-in.	FEC
-------------	--------------------------	----------------------------	----------	------------	-----



Fiber Optic Rollable Ribbon Breakout Kits	Fibers	Connector	Polarity Method	Jacket Material	Outer Diameter	Description Code	Part Number
Fiber Optic Rollable Ribbon Breakout Kit, 12F/ribbon, 12F/tube, 144 fiber cable	144					BLK-ROLB-A12-144	<a href="#">760239284</a>
Fiber Optic Rollable Ribbon Breakout Kit, 12F/ribbon, 12F/tube, 288 fiber cable	288					BLK-ROLB-A24-288	<a href="#">760239285</a>
Fiber Optic Rollable Ribbon Breakout Kit, 12F/ribbon, 12F/tube, 432 fiber cable	432					BLK-ROLB-A36-432	<a href="#">760239286</a>
Fiber Optic Rollable Ribbon Breakout Kit, 12F/ribbon, 12F/tube, 576 fiber cable	576					BLK-ROLB-A48-576	<a href="#">760239287</a>
Fiber Optic Rollable Ribbon Breakout Kit, 12F/ribbon, 12F/tube, 864 fiber cable	864					BLK-ROLB-A72-864	<a href="#">760239288</a>
Armor Kits For Grounding Interlocking Armored Rollable Ribbon Cable	Cable Size Supported				Package Quantity	Description Code	Part Number
Armor kit for 576 & 864F Rollable Ribbon Cables	576 & 864F				1	BLK-Armor-576/864	<a href="#">760239335</a>
Armor kit for 432F Rollable Ribbon Cables	432F				1	BLK-ARMOR-432	<a href="#">760239334</a>
Armor kit for 288F Rollable Ribbon Cables	288F				1	BLK-ARMOR-288	<a href="#">760239333</a>
Armor kit for 12, 24, 48, 72, & 144F Rollable Ribbon Cables	up to 144F				1	BLK-Armor-12/24/48/72/144	<a href="#">760239332</a>
Field Fusion Splice Connectors	Connector	Fits To	Optical Performance	Connector/Boot Color	Number of Connectors Per MID	Description Code	Part Number
Qwik-Fuse MPO Connector, OS2, Unpinned, High Optical Performance, Kit Includes 1x SMOUV Splice Protector	MPO-12/APC (Unpinned/Female)	3.0 mm round cable	Max IL 0.35 dB	Yellow/Black	1	SFC-12MP-8LL-30-YL	<a href="#">760249953</a>
Qwik-Fuse MPO Connector, OS2, Pinned, High Optical Performance, Kit Includes 1x SMOUV Splice Protector	MPO-12/APC (Pinned/Male)	3.0 mm round cable	Max IL 0.35 dB	Yellow/Black	1	SFC-12MX-8LL-30-YL	<a href="#">760249956</a>
Qwik-Fuse MPO Connector, OS2, Unpinned, Kit Includes 1x SMOUV Splice Protector	MPO-12/APC (Unpinned/Female)	3.0 mm round cable	Max IL 0.75 dB	Green/Black	1	SFC-12MP-8SP-30-GR	<a href="#">760251301</a>
Qwik-Fuse MPO Connector, OS2, Pinned, Kit Includes 1x SMOUV Splice Protector	MPO-12/APC (Pinned/Male)	3.0 mm round cable	Max IL 0.75 dB	Green/Black	1	SFC-12MX-8SP-30-GR	<a href="#">760251302</a>
MPO Connector Field Fusion Splice Accessories	Connector	Fits To	Optical Performance	Connector/Boot Color	Number of Connectors Per MID	Description Code	Part Number
Sumitomo Mass Fusion Splicer	Not supplied by CommScope. Please contact Sumitomo, or one of their approved partners, for further details.						Type-Q101-M12
Qwik-Fuse MPO Connector Splice Holder	Not supplied by CommScope. Please contact Sumitomo, or one of their approved partners, for further details.						FHM-12-MPO-MTL
Qwik-Fuse MPO Termination Kit (includes: Assembly Platform, Ferrule Holder, Instruction Sheet, Jacket Stripper/Slitting Tool, Magnifier, Marker, Ribbonizing Glue, Ribbonizing Tool, Soft Case)					1	KIT-TERMINATION-QWIK MPO	<a href="#">760188698</a>



Qwik-Fuse MPO Connector, UNPINNED, Singlemode-APC, Green, for 3.0 mm round cable

Direct System Selection Index

FEC	FACT ODF	UMSC	Flex Frame ODF, 19-in. Propel Panels	FOSC 600	19-in. Splice Solutions	Singlemode Fiber Cables	Singlemode Patch Cord, Cable Mgmt Products	Pre-term 19-in. Fiber	Pre-term FACT ODF Fiber	FiberGuide	Copper Category 6A	Powered Fiber	DIN Rail Solutions	Fiber Wall Boxes	2 Post Equipment Racks	imVision®
-----	----------	------	--------------------------------------	----------	-------------------------	-------------------------	--	-----------------------	-------------------------	------------	--------------------	---------------	--------------------	------------------	------------------------	-----------

Architecture System Selection Index

Colocation Campus and Building Infrastructure

Fiber Entrance, Meet-Me Room	High Fiber Count DC Interconnect	Campus Cabling	Building Cabling	Campus Cabling for Wi-Fi and Security
------------------------------	----------------------------------	----------------	------------------	---------------------------------------

Customer Space Cabling Infrastructure

MDA Fiber	EDA Fiber	EDA Copper	FiberGuide Raceway
-----------	-----------	------------	--------------------

Reference Designs and Technical Information

MDA Cabinet	MDA Cross-connect 19-in.	MDA Cross-connect FACT ODF	IDF FACT	IDF 19-in.	FEC
-------------	--------------------------	----------------------------	----------	------------	-----



# FiberGuide<sup>®</sup> Raceway Systems



FiberGuide is a raceway system designed to protect and route fiber optic patch cords to and from fiber splice enclosures, fiber distribution frames, and fiber optic terminal devices. FiberGuide ensures a 2-in. minimum bend radius is maintained throughout the system. Tool-less, Snap-Fit® junctions, cover options, and Plenum Express Exit® drops significantly reduce the amount of time required for installation.

The FiberGuide system is a complete set of products designed and manufactured to ensure total off-frame protection and ease of use. Basic components include horizontal and vertical straight sections, horizontal and vertical elbows, downspouts, junctions, and numerous support hardware and flex-tube kits.

**Speed of installation**

FiberGuide systems feature a variety of products that allow for quick and easy installation. Express Exit drops as well as tool-less products including Snap-Fit junctions, snap-on covers and new-hinged cover options save valuable time for installers.

**Speed of deployment**

The Express Exit system enables new drops to be added or removed quickly and easily. A drop can be added into a fully loaded raceway in seconds—without cutting.

**Raceway flexibility**

FiberGuide features 38 support structures, over 75 fittings, multiple drop options, and several other components to suit any application you create.

**Fiber protection**

Our broadband expertise translates into maximum protection for your network. 2-in. minimum bend radius is maintained throughout the system regardless of the raceway size.

**Strength and durability**

One-hundred percent raceway reliability—stands up to any challenge.

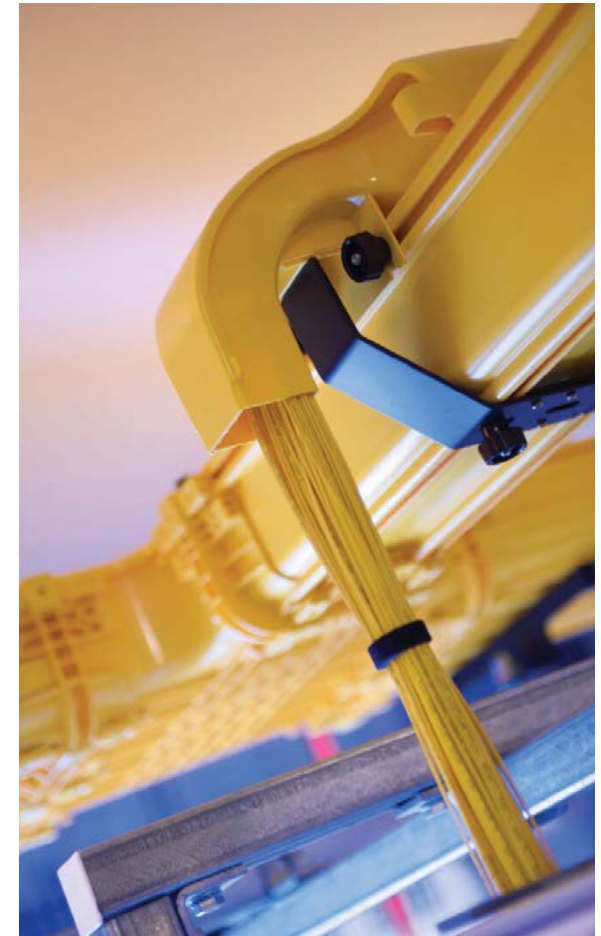

Access the complete [FiberGuide Ordering Guide here.](#)

**Direct System Selection Index**

FEC	FACT ODF	UMSC	Flex Frame ODF, 19-in. Propel Panels	FOSC 600	19-in. Splice Solutions	Singlemode Fiber Cables	Singlemode Patch Cord, Cable Mgmt Products	Pre-term 19-in. Fiber	Pre-term FACT ODF Fiber	FiberGuide	Copper Category 6A	Powered Fiber	DIN Rail Solutions	Fiber Wall Boxes	2 Post Equipment Racks	imVision®
-----	----------	------	--------------------------------------	----------	-------------------------	-------------------------	--	-----------------------	-------------------------	------------	--------------------	---------------	--------------------	------------------	------------------------	-----------

**Architecture System Selection Index**

**Colocation Campus and Building Infrastructure**

Fiber Entrance, Meet-Me Room	High Fiber Count DC Interconnect	Campus Cabling	Building Cabling	Campus Cabling for Wi-Fi and Security
------------------------------	----------------------------------	----------------	------------------	---------------------------------------

**Customer Space Cabling Infrastructure**

MDA Fiber	EDA Fiber	EDA Copper	FiberGuide Raceway
-----------	-----------	------------	--------------------

**Reference Designs and Technical Information**

MDA Cabinet	MDA Cross-connect 19-in.	MDA Cross-connect FACT ODF	IDF FACT	IDF 19-in.	FEC
-------------	--------------------------	----------------------------	----------	------------	-----







Review additional FiberGuide products here.





### 4-in. x 6-in. FiberGuide System

Description	Part Number	
4x6 Horizontal Straight Section, 6-ft. long, yellow	<a href="#">FGS-MSHS-B</a>	
4x6 Horizontal Stack Storage Section, yellow	<a href="#">FGS-MSHS-STOR-B</a>	
4x6 Horizontal T, yellow	<a href="#">FGS-MHRT-B</a>	
4x6 Horizontal Cross, yellow	<a href="#">FGS-MHXP-B</a>	
4x6 Horizontal Elbow 90°, yellow	<a href="#">FGS-MH9E-B</a>	
4x6 Down Spout, yellow	<a href="#">FGS-MDSP-B</a>	
4x6 Trumpet Flare, yellow	<a href="#">FGS-MTRM-B</a>	
4x6 Down Elbow 45°, yellow	<a href="#">FGS-MD4E-B</a>	
4x6 Up Elbow 45°, yellow	<a href="#">FGS-MU4E-B</a>	
4x6 Junction	<a href="#">FGS-MFAW-B</a>	
4x6 End Cap, black	<a href="#">FGS-HMEC-B</a>	

### 4-in. x 6-in. Supports

Description	Part Number	
L Bay Support Bracket	<a href="#">FGS-HLBK</a>	
Center Support Bracket Kit (xx = size: 1/2-in., 5/8-in., 12 mm, 14 mm, 16 mm)	<a href="#">FGS-HTUB</a>	
Top Support C-Bracket Kit (xx = size: 1/2-in., 5/8-in., 12 mm, 14 mm, 16 mm)	<a href="#">FGS-HNTS</a>	
Unistrut Kit; 10 Quick Knob T-Bolt	<a href="#">FGS-ACC532</a>	

### Express Exits

Description	Part Number	
4-in. Express Exit with 4x4 exit opening, yellow	<a href="#">FGS-MEXP-E-A/B/F</a>	
2-in. Low Profile Express Exit with 2x2 exit opening, yellow	<a href="#">FGS-MEXP-LP-A/B/F</a>	
2x2 Trumpet Flare for 2-in. Express Exits, yellow	<a href="#">FGS-MTRM-C</a>	
Single 2-in. Flex Tube Attachment 2-in. flex tube and 2x2 junction to attach to Express Exit		
5-ft. length	<a href="#">FGS-MEXI-C-5F</a>	
10-ft. length	<a href="#">FGS-MEXI-C-10F</a>	
15-ft. length	<a href="#">FGS-MEXI-C-15F</a>	

### Direct System Selection Index

FEC	FACT ODF	UMSC	Flex Frame ODF, 19-in. Propel Panels	FOSC 600	19-in. Splice Solutions	Singlemode Fiber Cables	Singlemode Patch Cord, Cable Mgmt Products	Pre-term 19-in. Fiber	Pre-term FACT ODF Fiber	FiberGuide	Copper Category 6A	Powered Fiber	DIN Rail Solutions	Fiber Wall Boxes	2 Post Equipment Racks	imVision®
-----	----------	------	--------------------------------------	----------	-------------------------	-------------------------	--	-----------------------	-------------------------	------------	--------------------	---------------	--------------------	------------------	------------------------	-----------

### Architecture System Selection Index

#### Colocation Campus and Building Infrastructure

Fiber Entrance, Meet-Me Room	High Fiber Count DC Interconnect	Campus Cabling	Building Cabling	Campus Cabling for Wi-Fi and Security
------------------------------	----------------------------------	----------------	------------------	---------------------------------------

#### Customer Space Cabling Infrastructure

MDA Fiber	EDA Fiber	EDA Copper	FiberGuide Raceway
-----------	-----------	------------	--------------------

#### Reference Designs and Technical Information

MDA Cabinet	MDA Cross-connect 19-in.	MDA Cross-connect FACT ODF	IDF FACT	IDF 19-in.	FEC
-------------	--------------------------	----------------------------	----------	------------	-----





Review additional FiberGuide products here.

### 4-in. x 12-in. FiberGuide System

Description	Part Number	
4x12 Horizontal Straight Section, 6-ft. long, yellow	<a href="#">FGS-MSHS-F</a>	
4x12 Horizontal Slack Storage Section, yellow	<a href="#">FGS-MSHS-STOR-F</a>	
4x12 Horizontal T, yellow	<a href="#">FGS-MHRT-F</a>	
4x12 Horizontal Cross, yellow	<a href="#">FGS-MHXP-F</a>	
4x12 Horizontal Elbow 90°, yellow	<a href="#">FGS-MH9E-F</a>	
4x12 Down Spout, yellow	<a href="#">FGS-MDSP-F</a>	
4x12 Trumpet Flare, yellow	<a href="#">FGS-MTRM-F</a>	
4x12 Horizontal Cross with two 6-in. exit, yellow	<a href="#">FGS-MHXP-B/F</a>	
4x12 Down Elbow 45°, yellow	<a href="#">FGS-MD4E-F</a>	
4x12 Up Elbow 45°, yellow	<a href="#">FGS-MU4E-F</a>	
4x12 Junction	<a href="#">FGS-MFAW-F</a>	
4x12 End Cap	<a href="#">FGS-HMEC-F</a>	
Trapeze Bracket Kit (xx = size: 1/2-in., 5/8-in., 12 mm, 14 mm, 16 mm)	<a href="#">FGS-HNTP-F-XX</a>	

### 4-in. x 24-in. FiberGuide System

Description	Part Number	
4x24 Horizontal Straight Section, 6-in. long, yellow	<a href="#">FGS-MSHS-H</a>	
4x24 Horizontal T, with single 12-in. exit, yellow	<a href="#">FGS-MHRT-H/F</a>	
4x24 Horizontal T with three 24-in. exits, yellow	<a href="#">FGS-MHRT-H</a>	
4x24 Horizontal Cross, yellow	<a href="#">FGS-MHXP-H</a>	
4x24 Horizontal Cross with dual 12-in. exits	<a href="#">FGS-MHXP-F/H</a>	
4x24 Horizontal Elbow 45°, yellow	<a href="#">FGS-MH4E-H</a>	
4x24 Down Elbow 45°, yellow	<a href="#">FGS-MD4E-H</a>	
4x24 Up Elbow 45°, yellow	<a href="#">FGS-MU4E-H</a>	
4x24 Junction	<a href="#">FGS-MFAW-H</a>	
4x24 End Cap	<a href="#">FGS-HMEC-H</a>	
Threaded Rod Trapeze Bracket Kit for New, 5/8-in.	<a href="#">FGS-HNTP-H-5/8</a>	

### Direct System Selection Index

FEC	FACT ODF	UMSC	Flex Frame ODF, 19-in. Propel Panels	FOSC 600	19-in. Splice Solutions	Singlemode Fiber Cables	Singlemode Patch Cord, Cable Mgmt Products	Pre-term 19-in. Fiber	Pre-term FACT ODF Fiber	FiberGuide	Copper Category 6A	Powered Fiber	DIN Rail Solutions	Fiber Wall Boxes	2 Post Equipment Racks	imVision®
-----	----------	------	--------------------------------------	----------	-------------------------	-------------------------	--	-----------------------	-------------------------	------------	--------------------	---------------	--------------------	------------------	------------------------	-----------

### Architecture System Selection Index

#### Colocation Campus and Building Infrastructure

Fiber Entrance, Meet-Me Room	High Fiber Count DC Interconnect	Campus Cabling	Building Cabling	Campus Cabling for Wi-Fi and Security
------------------------------	----------------------------------	----------------	------------------	---------------------------------------

#### Customer Space Cabling Infrastructure

MDA Fiber	EDA Fiber	EDA Copper	FiberGuide Raceway
-----------	-----------	------------	--------------------

#### Reference Designs and Technical Information

MDA Cabinet	MDA Cross-connect 19-in.	MDA Cross-connect FACT ODF	IDF FACT	IDF 19-in.	FEC
-------------	--------------------------	----------------------------	----------	------------	-----

# Category 6A Systems



Pre-terminated    Field Installable    Unshielded

Evolve U/UTP Panel, Field Installable		Copper Tech	Description Code		Part Number
	SYSTIMAX GigaSPEED X10D Evolve 1U U/UTP Panel Kit	U/UTP	360-E-MOD-1U-24		<a href="#">760187187</a>
Evolve Mixed Media Panels		Copper Tech	Description Code		Part Number
	SYSTIMAX GigaSPEED X10D and GigaSPEED XL Evolve 1U U/UTP Panel Kit	U/UTP	360-E-KIT-1U		<a href="#">760155739</a>
Evolve Mixed Media Panels Accessories			Description Code	Part Number	
SYSTIMAX 360 1100 Evolve G2 BEZEL (Cool Gray)			360-1100-E-FB-4PK	<a href="#">760175877</a>	
SYSTIMAX 360 1100 Evolve Fiber Cable Management			361 1100-E-FCM	<a href="#">760175919</a>	
SYSTIMAX 360 1100 Evolve G2 BEZEL (Blank)			360-1100-E-BB	<a href="#">760165191</a>	
InstaPATCH Copper Trunks Pre-terminated		Copper Tech	Jacket Material	Description Code	Part Number
	InstaPATCH Cu GigaSPEED X10D U/UTP Riser Preterminated Copper Cable, 360 1100 Evolve module to 360 1100 Evolve module, 6 links, Blue Jacket	U/UTP	Riser	CBRRB-11SAOZ	<a href="#">CBRRB-11SAOZ</a>
	InstaPATCH Cu GigaSPEED X10D U/UTP Plenum Preterminated Copper Cable, 360 1100 Evolve module to 360 1100 Evolve module, 6 links, Blue Jacket	U/UTP	Plenum	CARRB-11SAOZ	<a href="#">CARRB-11SAOZ</a>
Field Installable Category 6A Copper Cable		Copper Tech	Jacket Material	Description Code	Part Number
	GigaSPEED X10D 2091B ETL Verified Category 6A U/UTP Cable, Blue Jacket, 4 pair count, 1000 ft (305 m) length, WE TOTE® box	U/UTP	Plenum	2091B BLU C6A 4/23 U/UTP W1000	<a href="#">760107201</a>
	GigaSPEED X10D 1091B ETL Verified Category 6A U/UTP Cable, Blue Jacket, 4 pair count, 1000 ft (305 m) length, WE TOTE® box	U/UTP	Non-Plenum	1091B BLU C6A 4/23 U/UTP W1000	<a href="#">760107094</a>
Field Installable Category 6A Information Outlets		Cu Tech	Jacket Material	Description Code	Part Number
	GigaSPEED X10D MGS600 Series Information Outlet, black	UTP	N/A	MGS600-003	<a href="#">760092361</a>
Copper Patch Cords		Copper Tech	Jacket Material	Description Code	Part Number
	MiNo6A Series Category 6A U/UTP Reduced Diameter LS-CM Dual Rated Cord	UTP	LSZH/Riser	MINO6A-BL	<a href="#">C0199K2-08</a>



Access the InstaPATCH System Brochure and Ordering Guide [here](#).

## Direct System Selection Index

FEC	FACT ODF	UMSC	Flex Frame ODF, 19-in. Propel Panels	FOSC 600	19-in. Splice Solutions	Singlemode Fiber Cables	Singlemode Patch Cord, Cable Mgmt Products	Pre-term 19-in. Fiber	Pre-term FACT ODF Fiber	FiberGuide	Copper Category 6A	Powered Fiber	DIN Rail Solutions	Fiber Wall Boxes	2 Post Equipment Racks	imVision®
-----	----------	------	--------------------------------------	----------	-------------------------	-------------------------	--	-----------------------	-------------------------	------------	--------------------	---------------	--------------------	------------------	------------------------	-----------

## Architecture System Selection Index

### Colocation Campus and Building Infrastructure

Fiber Entrance, Meet-Me Room	High Fiber Count DC Interconnect	Campus Cabling	Building Cabling	Campus Cabling for Wi-Fi and Security
------------------------------	----------------------------------	----------------	------------------	---------------------------------------

### Customer Space Cabling Infrastructure

MDA Fiber	EDA Fiber	EDA Copper	FiberGuide Raceway
-----------	-----------	------------	--------------------

### Reference Designs and Technical Information

MDA Cabinet	MDA Cross-connect 19-in.	MDA Cross-connect FACT ODF	IDF FACT	IDF 19-in.	FEC
-------------	--------------------------	----------------------------	----------	------------	-----



# Powered Fiber Systems



## Application

Deployment of HD cameras, Wi-Fi access points, optical network terminals, small cells (picocells, femtocells, metrocells, etc.) and other network access devices can be difficult, especially in outdoor environments. Many of these devices accept a power over Ethernet (PoE) input for power and communications. However, the PoE distance limitation of 100 meters can cause difficulties with network planning.

Also, power is not always readily available in the precise locations where device placement is needed to improve 4G LTE and/or 802.11 Wi-Fi coverage for wireless networks, such as on the sides of buildings, lamp posts, etc. In these situations, it is typically necessary to run power to the desired location prior to installing the devices. Also, any concern about who pays for that power and how it is monitored requires wireless network operators to negotiate with local utility companies and building owners. All of this adds time and money to the installation of network access devices.

CommScope has developed a solution that combines power and optical fiber communications into one system, eliminating the hassles and extra expense associated with powering typical low-power network devices.

## Features

- Hybrid optical fiber and copper cabling with outdoor and indoor/outdoor versions
- Incorporates dc/dc conversion technology to simplify dc line powering calculations
- Primary, secondary, and tertiary electrical protection
- Media converter for delivering PoE and PoE+ capability
- SELV and NEC Class 2 compliant

## Applications

- Security cameras
- Wi-Fi access points

- Wireless network small cells
- Optical network terminals
- Digital signage
- Emergency phones
- Additional devices needing PoE signal

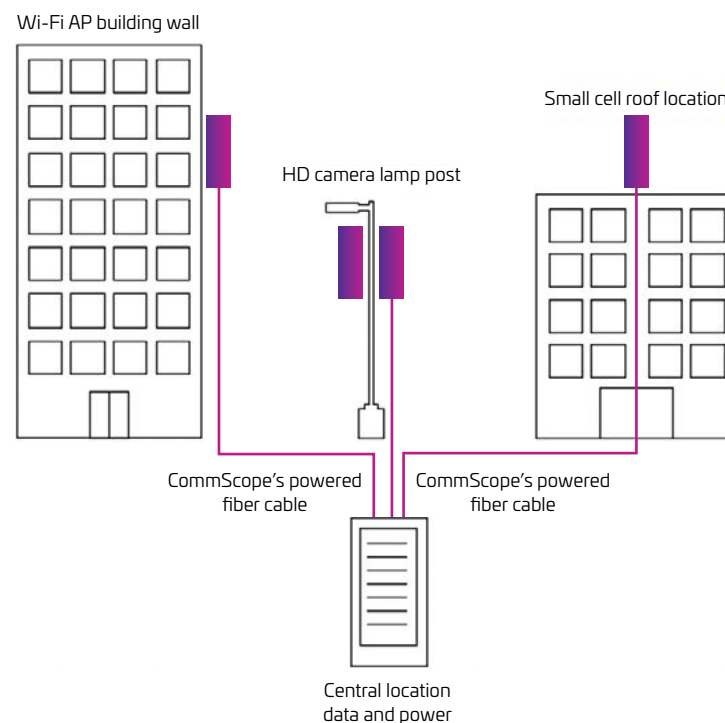

## Direct System Selection Index

FEC	FACT ODF	UMSC	Flex Frame ODF, 19-in. Propel Panels	FOSC 600	19-in. Splice Solutions	Singlemode Fiber Cables	Singlemode Patch Cord, Cable Mgmt Products	Pre-term 19-in. Fiber	Pre-term FACT ODF Fiber	FiberGuide	Copper Category 6A	Powered Fiber	DIN Rail Solutions	Fiber Wall Boxes	2 Post Equipment Racks	imVision®
-----	----------	------	--------------------------------------	----------	-------------------------	-------------------------	--	-----------------------	-------------------------	------------	--------------------	---------------	--------------------	------------------	------------------------	-----------

## Architecture System Selection Index

### Colocation Campus and Building Infrastructure

Fiber Entrance, Meet-Me Room	High Fiber Count DC Interconnect	Campus Cabling	Building Cabling	Campus Cabling for Wi-Fi and Security
------------------------------	----------------------------------	----------------	------------------	---------------------------------------

### Customer Space Cabling Infrastructure

MDA Fiber	EDA Fiber	EDA Copper	FiberGuide Raceway
-----------	-----------	------------	--------------------

### Reference Designs and Technical Information

MDA Cabinet	MDA Cross-connect 19-in.	MDA Cross-connect FACT ODF	IDF FACT	IDF 19-in.	FEC
-------------	--------------------------	----------------------------	----------	------------	-----



## 1- and 2-Port PoE Extenders

- IP68 sealing—Enclosures are designed for outdoor installations with protection from moisture and the environment.
- Automatically corrects for distance voltage drop in the hybrid cable.
- Integrated Electrical Protection
- 60W 2-port variant enables 2 PoE or PoE+ devices to be connected via one hybrid cable.
- 60W single port variation supports 802.3bt, Class 6 power levels. It can be equipped with SPF+ transceivers, and deliver 5 Gbps Ethernet over the copper port.

## Power Supplies

- 57VDC Power Supply for use with Powered Fiber Cable System

## Support Materials

- [Find calculators and component details here.](#)
- [Find installation tips for the power supply at the central location here.](#)

Powered Fiber Cables	Part Number/MID
Powered Fiber Cable, Indoor/Outdoor, OS2, 2 Fibers, 2 x 12 AWG Conductors	<a href="#">PFC-S02L12</a>
Powered Fiber Cable, Indoor/Outdoor, OS2, 2 Fibers, 2 x 16 AWG Conductors	<a href="#">PFC-S02L16</a>
Powered Fiber Cable, Outdoor, OS2, 2 Fibers, 2 x 12 AWG Conductors	<a href="#">PFC-S02O12</a>
Powered Fiber Cable, Outdoor, OS2, 2 Fibers, 2 x 16 AWG Conductors	<a href="#">PFC-S02O16</a>
Powered Fiber Cable, Indoor/Outdoor, OS2, 4 Fibers, 2 x 12 AWG Conductors	<a href="#">PFC-S04L12</a>
Powered Fiber Cable, Indoor/Outdoor, OS2, 4 Fibers, 2 x 16 AWG Conductors	<a href="#">PFC-S04L16</a>
Powered Fiber Cable, Outdoor, OS2, 4 Fibers, 2 x 12 AWG Conductors	<a href="#">PFC-S04O12</a>
Powered Fiber Cable, Outdoor, OS2, 4 Fibers, 2 x 16 AWG Conductors	<a href="#">PFC-S04O16</a>
Powered Fiber Cable, Indoor/Outdoor, OS2, 12 Fibers, 2 x 12 AWG Conductors	<a href="#">PFC-S12L12</a>
Powered Fiber Cable, Indoor/Outdoor, OS2, 2 Fibers, 12 x 16 AWG Conductors	<a href="#">PFC-S12L16</a>
Powered Fiber Cable, Outdoor, OS2, 12 Fibers, 2 x 12 AWG Conductors	<a href="#">PFC-S12O12</a>
Powered Fiber Cable, Outdoor, OS2, 12 Fibers, 2 x 16 AWG Conductors	<a href="#">PFC-S12O16</a>
Powered Fiber Cable, Indoor/Outdoor, OM3, 2 Fibers, 2 x 12 AWG Conductors	<a href="#">PFC-302L12</a>
Powered Fiber Cable, Indoor/Outdoor, OM3, 2 Fibers, 2 x 16 AWG Conductors	<a href="#">PFC-302L16</a>
Powered Fiber Cable, Outdoor, OM3, 2 Fibers, 2 x 12 AWG Conductors	<a href="#">PFC-302O12</a>
Powered Fiber Cable, Outdoor, OM3, 2 Fibers, 2 x 16 AWG Conductors	<a href="#">PFC-302O16</a>
Powered Fiber Cable, Indoor/Outdoor, OM3, 4 Fibers, 2 x 12 AWG Conductors	<a href="#">PFC-304L12</a>
Powered Fiber Cable, Indoor/Outdoor, OM3, 4 Fibers, 2 x 16 AWG Conductors	<a href="#">PFC-304L16</a>
Powered Fiber Cable, Outdoor, OM3, 4 Fibers, 2 x 12 AWG Conductors	<a href="#">PFC-304O12</a>
Powered Fiber Cable, Outdoor, OM3, 4 Fibers, 2 x 16 AWG Conductors	<a href="#">PFC-304O16</a>

1- and 2-Port PoE Extenders	Part Number/MID
60W, 2 Port PoE Extender (provides a maximum of 30W on each port)	<a href="#">PFU-P-C-O-060-02</a>
60W, 1 Port 5 Gbps PoE Extender	<a href="#">PFU-P-E-O-060-01</a>
Power Supplies	Part Number/MID
Power Express Distribution shelf with alarm module	<a href="#">PFP-PX-S1</a>
Power Express Distribution module supports max. 8 Devices	<a href="#">PFP-PX-8M</a>
Power Express Blank Slot Panel	<a href="#">PFP-PX-SF</a>
SPS Rectifier Power Distribution Shelf	<a href="#">PFP-SPS-S1</a>
1600W SPS Power Rectifier module	<a href="#">PFP-SPS-1600M</a>
SPS Rectifier Controller Display	<a href="#">PFP-SPS-C1</a>
SPS Rectifier Blank Slot Panel	<a href="#">PFP-SPS-SF</a>



## Direct System Selection Index

FEC	FACT ODF	UMSC	Flex Frame ODF, 19-in. Propel Panels	FOSC 600	19-in. Splice Solutions	Singlemode Fiber Cables	Singlemode Patch Cord, Cable Mgmt Products	Pre-term 19-in. Fiber	Pre-term FACT ODF Fiber	FiberGuide	Copper Category 6A	Powered Fiber	DIN Rail Solutions	Fiber Wall Boxes	2 Post Equipment Racks	imVision®
-----	----------	------	--------------------------------------	----------	-------------------------	-------------------------	--	-----------------------	-------------------------	------------	--------------------	---------------	--------------------	------------------	------------------------	-----------

## Architecture System Selection Index

### Colocation Campus and Building Infrastructure

Fiber Entrance, Meet-Me Room	High Fiber Count DC Interconnect	Campus Cabling	Building Cabling	Campus Cabling for Wi-Fi and Security
------------------------------	----------------------------------	----------------	------------------	---------------------------------------

### Customer Space Cabling Infrastructure

MDA Fiber	EDA Fiber	EDA Copper	FiberGuide Raceway
-----------	-----------	------------	--------------------

### Reference Designs and Technical Information

MDA Cabinet	MDA Cross-connect 19-in.	MDA Cross-connect FACT ODF	IDF FACT	IDF 19-in.	FEC
-------------	--------------------------	----------------------------	----------	------------	-----



# DIN Rail Solutions for BMS Networks



A Building Management System (BMS), or Building Energy Management System (BEMS), supports the automatic centralized control of a building's HVAC (heating, ventilation and air conditioning), electrical, lighting, shading, access control, security systems, and other interrelated systems.

In addition to controlling the building's internal environment, BMS systems are sometimes linked to access control or other security systems such as closed-circuit television (CCTV), motion detectors, fire alarm systems, and elevators for monitoring.

Many of the devices used to enable the applications mentioned in the previous paragraph have a non-standard foot print, or are located in places where a traditional 19-in rack or cabinet cannot be placed. In this instance, DIN (Deutsche Instiut fur Normung), a rail-mounted metal strip system, is deployed to securely attach those electrical and industrial control products and sensors.



SMOUV Splice Protectors



Splice Holder Kit



Fiber Adapter Pack

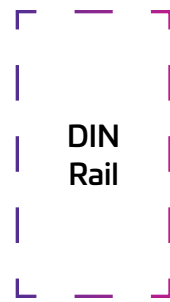

DIN Rail



DIN Rail Mounting Bracket



Enclosure



Adapter Bracket



BMS Device



Copper Faceplate



Fiber Pig Tail



Copper Jack

## Direct System Selection Index

FEC	FACT ODF	UMSC	Flex Frame ODF, 19-in. Propel Panels	FOSC 600	19-in. Splice Solutions	Singlemode Fiber Cables	Singlemode Patch Cord, Cable Mgmt Products	Pre-term 19-in. Fiber	Pre-term FACT ODF Fiber	FiberGuide	Copper Category 6A	Powered Fiber	DIN Rail Solutions	Fiber Wall Boxes	2 Post Equipment Racks	imVision®
-----	----------	------	--------------------------------------	----------	-------------------------	-------------------------	--	-----------------------	-------------------------	------------	--------------------	---------------	--------------------	------------------	------------------------	-----------

## Architecture System Selection Index

### Colocation Campus and Building Infrastructure

Fiber Entrance, Meet-Me Room	High Fiber Count DC Interconnect	Campus Cabling	Building Cabling	Campus Cabling for Wi-Fi and Security
------------------------------	----------------------------------	----------------	------------------	---------------------------------------

### Customer Space Cabling Infrastructure

MDA Fiber	EDA Fiber	EDA Copper	FiberGuide Raceway
-----------	-----------	------------	--------------------

### Reference Designs and Technical Information

MDA Cabinet	MDA Cross-connect 19-in.	MDA Cross-connect FACT ODF	IDF FACT	IDF 19-in.	FEC
-------------	--------------------------	----------------------------	----------	------------	-----





Review DIN Rail System Selection [here](#).

DIN Rail Mounting Bracket and Enclosure	Description Code	Part Number
DIN rail mounting bracket for WBE-EMT-BK-1P-PNL	WBE-1P-DIN-KIT	<a href="#">760239822</a>
Ready Wall Mount Building Enclosure, 1P, black, cable gland not included	WBE-EMT-BK-1P-PNL	<a href="#">760172288</a>
1000 Style to 360 Adapter Pack Bracket Kit (Kit of 3)	1000-360-ADPT-BRKT-KIT	<a href="#">760198325</a>
Fiber Pigtails and Accessories	Description Code	Part Number
TeraSPEED LC/UPC to Unconnectorized, Fiber Pigtail, 0.9 mm Tight Buffer		<a href="#">FAWLCUC01</a>
OM4 LC/UPC to Unconnectorized, 0.9 mm Tight Buffer Simplex Fiber Pigtail		<a href="#">FAXLCUC01</a>
SYSTIMAX 360 Fusion Splice Holder Kit, stackable	360-SPLICE-24-FUS	<a href="#">760148536</a>
Fiber Adapter Packs	Description Code	Part Number
360 Distribution Adapter Pack, Singlemode, 24 LC/UPC with internal shutters	360DPis-24LC-SM	<a href="#">760216762</a>
360 Distribution Adapter Pack, Singlemode, 12 LC/UPC with internal shutters	360DPis-12LC-SM	<a href="#">760230946</a>
360 Distribution Adapter Pack, Multimode OM4, 24 LC/UPC with internal shutters	360DPis-24LC-LS	<a href="#">760216754</a>
360 Distribution Adapter Pack, Multimode OM4, 12 LC/UPC with internal shutters	360DPis-12LC-LS	<a href="#">760230938</a>
Copper Faceplate and Jacks	Description Code	Part Number
G2 Multimedia Outlet Bezel for G2 Modular Shelf, Accepts 4 MGS Jacks	MODG2-MGS	<a href="#">760032110</a>
C6A UTP GigaSPEED X10D MGS600 Series Information Outlet, black, quantity 1	MGS600-003	<a href="#">760092361</a>
GigaSPEED XL MGS400 Series Category 6 U/UTP Information Outlet, black, quantity 1	MGS400-003	<a href="#">700206667</a>

## Direct System Selection Index

FEC	FACT ODF	UMSC	Flex Frame ODF, 19-in. Propel Panels	FOSC 600	19-in. Splice Solutions	Singlemode Fiber Cables	Singlemode Patch Cord, Cable Mgmt Products	Pre-term 19-in. Fiber	Pre-term FACT ODF Fiber	FiberGuide	Copper Category 6A	Powered Fiber	DIN Rail Solutions	Fiber Wall Boxes	2 Post Equipment Racks	imVision®
-----	----------	------	--------------------------------------	----------	-------------------------	-------------------------	--	-----------------------	-------------------------	------------	--------------------	---------------	--------------------	------------------	------------------------	-----------

## Architecture System Selection Index

### Colocation Campus and Building Infrastructure

Fiber Entrance, Meet-Me Room	High Fiber Count DC Interconnect	Campus Cabling	Building Cabling	Campus Cabling for Wi-Fi and Security
------------------------------	----------------------------------	----------------	------------------	---------------------------------------

### Customer Space Cabling Infrastructure

MDA Fiber	EDA Fiber	EDA Copper	FiberGuide Raceway
-----------	-----------	------------	--------------------

### Reference Designs and Technical Information

MDA Cabinet	MDA Cross-connect 19-in.	MDA Cross-connect FACT ODF	IDF FACT	IDF 19-in.	FEC
-------------	--------------------------	----------------------------	----------	------------	-----



# Fiber Wall Boxes for Fiber Entrance Applications



Fiber Wall Boxes	Dimensions, mm (inches)	Description Code	Part Number
Wall Mount Building Enclosure configured for one G2 Style module, splice cassette or adapter pack, cable gland not included	139.7 x 262.64 x 35.81 (5.5 x 10.34 x 1.410)	WB2-EMT-BK-1P-MOD	<a href="#">760248900</a>
Wall Mount Building Enclosure configured for two G2 Style modules, splice cassettes or adapter packs, cable gland not included	284.99 x 367.28 x 52.83 (11.22 x 14.46 x 2.08)	WB2-EMT-BK-2P-MOD	<a href="#">760248901</a>
Wall Mount Building Enclosure configured for four G2 style modules, splice cassettes or adapter packs, cable gland not included	284.99 x 367.28 x 98.55 (11.22 x 14.46 x 3.88)	WB2-EMT-BK-4P-MOD	<a href="#">760248902</a>
Wall Mount Building Enclosure configured for eight G2 Style modules, splice cassettes or adapter packs, cable gland not included	284.99 x 367.28 x 158.75 (11.22 x 14.46 x 6.25)	WB2-EMT-BK-8P-MOD	<a href="#">760248903</a>



## Direct System Selection Index

FEC	FACT ODF	UMSC	Flex Frame ODF, 19-in. Propel Panels	FOSC 600	19-in. Splice Solutions	Singlemode Fiber Cables	Singlemode Patch Cord, Cable Mgmt Products	Pre-term 19-in. Fiber	Pre-term FACT ODF Fiber	FiberGuide	Copper Category 6A	Powered Fiber	DIN Rail Solutions	Fiber Wall Boxes	2 Post Equipment Racks	imVision®
-----	----------	------	--------------------------------------	----------	-------------------------	-------------------------	--	-----------------------	-------------------------	------------	--------------------	---------------	--------------------	------------------	------------------------	-----------

## Architecture System Selection Index

### Colocation Campus and Building Infrastructure

Fiber Entrance, Meet-Me Room	High Fiber Count DC Interconnect	Campus Cabling	Building Cabling	Campus Cabling for Wi-Fi and Security
------------------------------	----------------------------------	----------------	------------------	---------------------------------------

### Customer Space Cabling Infrastructure

MDA Fiber	EDA Fiber	EDA Copper	FiberGuide Raceway
-----------	-----------	------------	--------------------

### Reference Designs and Technical Information

MDA Cabinet	MDA Cross-connect 19-in.	MDA Cross-connect FACT ODF	IDF FACT	IDF 19-in.	FEC
-------------	--------------------------	----------------------------	----------	------------	-----



# 2 Post Equipment Racks and Accessories

Equipment Racks	Material	Static Load Rating	Packaging Type and Weight (net)	Description Code	Part Number
Equipment Rack, 2-Post, 3 in (76 mm) Channel x 7ft (2134 mm) H - 19 in (482.6 mm) Alu (45U) 12-24 Tapped Rails, Black	Aluminium	453.6 kg	Flat Packed 12.7 kg	RK3-45A	<a href="#">760082479</a>
Horizontal Cable Managers	Material	Color	Packaging Type and Weight (net)	Description Code	Part Number
Horizontal Trough Kit, 1 RU, 19 in, single sided	Aluminium, Steel	Black	Assembled 1.52 kg	HTK-19-SS-1U	<a href="#">760072942</a>
Horizontal Trough Kit, 2 RU, 19 in, single sided	Aluminium, Steel	Black	Assembled 2.05 kg	HTK-19-SS-2U	<a href="#">760072959</a>
Horizontal Trough Kit, 19 in rack mountable, double sided, 1 RU	Aluminium, Plastic, Steel	Black	Assembled	HTK-19-DS-1U	<a href="#">760128843</a>
Horizontal Trough Kit, 19 in rack mountable, double sided, 2 RU	Aluminium, Plastic, Steel	Black	Assembled	HTK-19-DS-2U	<a href="#">760128850</a>
Vertical Cable Managers, Silver	Material	Color	Packaging Type and Weight (net)	Description Code	Part Number
Vertical Cable Management Kit, 6 in x 84 in (152 mm x 2134 mm) Double Sided, With Doors	Metal	Silver	Assembled	VCM-DS-84-6	<a href="#">760244775</a>
Vertical Cable Management Kit, 8 in x 84 in (203 mm x 2134 mm) Double Sided, With Doors	Metal	Silver	Assembled	VCM-DS-84-8	<a href="#">760244776</a>
Vertical Cable Management Kit, 10 in x 84 in (254 mm x 2134 mm) Double Sided, With Doors	Metal	Silver	Assembled	VCM-DS-84-10	<a href="#">760244777</a>
Vertical Cable Management Kit, 12 in x 84 in (305 mm x 2134 mm) Double Sided, With Doors	Metal	Silver	Assembled	VCM-DS-84-12	<a href="#">760244778</a>
Vertical Cable Managers, Black	Material	Color	Packaging Type and Weight (net)	Description Code	Part Number
Vertical Cable Management Kit, 6 in x 84 in (152 mm x 2134 mm) Double Sided, With Doors	Metal	Black	Assembled	VCM-DS-84-6B	<a href="#">760244779</a>
Vertical Cable Management Kit, 8 in x 84 in (203 mm x 2134 mm) Double Sided, With Doors	Metal	Black	Assembled 30.391 kg	VCM-DS-84-8B	<a href="#">760244780</a>
Vertical Cable Management Kit, 10 in x 84 in (254 mm x 2134 mm) Double Sided, With Doors	Metal	Black	Assembled	VCM-DS-84-10B	<a href="#">760244781</a>
Vertical Cable Management Kit, 12 in x 84 in (305 mm x 2134 mm) Double Sided, With Doors	Metal	Black	Assembled	VCM-DS-84-12B	<a href="#">760244782</a>



Contact your local CommScope FAE for more details.

## Direct System Selection Index

FEC	FACT ODF	UMSC	Flex Frame ODF, 19-in. Propel Panels	FOSC 600	19-in. Splice Solutions	Singlemode Fiber Cables	Singlemode Patch Cord, Cable Mgmt Products	Pre-term 19-in. Fiber	Pre-term FACT ODF Fiber	FiberGuide	Copper Category 6A	Powered Fiber	DIN Rail Solutions	Fiber Wall Boxes	2 Post Equipment Racks	imVision®
-----	----------	------	--------------------------------------	----------	-------------------------	-------------------------	--	-----------------------	-------------------------	------------	--------------------	---------------	--------------------	------------------	------------------------	-----------

## Architecture System Selection Index

### Colocation Campus and Building Infrastructure

Fiber Entrance, Meet-Me Room	High Fiber Count DC Interconnect	Campus Cabling	Building Cabling	Campus Cabling for Wi-Fi and Security
------------------------------	----------------------------------	----------------	------------------	---------------------------------------

### Customer Space Cabling Infrastructure

MDA Fiber	EDA Fiber	EDA Copper	FiberGuide Raceway
-----------	-----------	------------	--------------------

### Reference Designs and Technical Information

MDA Cabinet	MDA Cross-connect 19-in.	MDA Cross-connect FACT ODF	IDF FACT	IDF 19-in.	FEC
-------------	--------------------------	----------------------------	----------	------------	-----



# CommScope's imVision® Platform



Data drives your network. To keep it flowing efficiently and freely, your physical layer infrastructure must be managed in real-time, using authoritative information—not assumptions. Gaining the visibility and insights needed to make the right decisions gets tougher as networks converge and grow more complex. That's why CommScope created imVision, the industry's leading automated infrastructure management (AIM) platform.

With an intuitive, web-based architecture, imVision delivers real-time intelligence and device discovery that allow you to monitor and document your cabling infrastructure while tracking the location of all connected network devices. It delivers actionable, real-time data and performance insights that enable you to optimize capacity, availability and efficiency. The critical information you need from the technology partner you trust.

### Optimize capacity

Today's networks are capacity-strained but often have resources that are not being utilized efficiently. A capacity upgrade is involved and costly and may even be unnecessary. How can you be sure?

### Optimize availability

Nobody can afford a service disruption. Worse yet, is the cost to resolve unplanned downtime. The best way to lower the cost is to prevent service issues from ever happening.

### Optimize efficiency

Nothing degrades network efficiency like stranded switch ports. Left unidentified, they continue to consume power and valuable white space. The cost and time needed to deploy and commission new servers is another efficiency-killer.

[Learn more about automated infrastructure management here.](#)

[Explore imVision case studies at commscope.com](https://commscope.com)

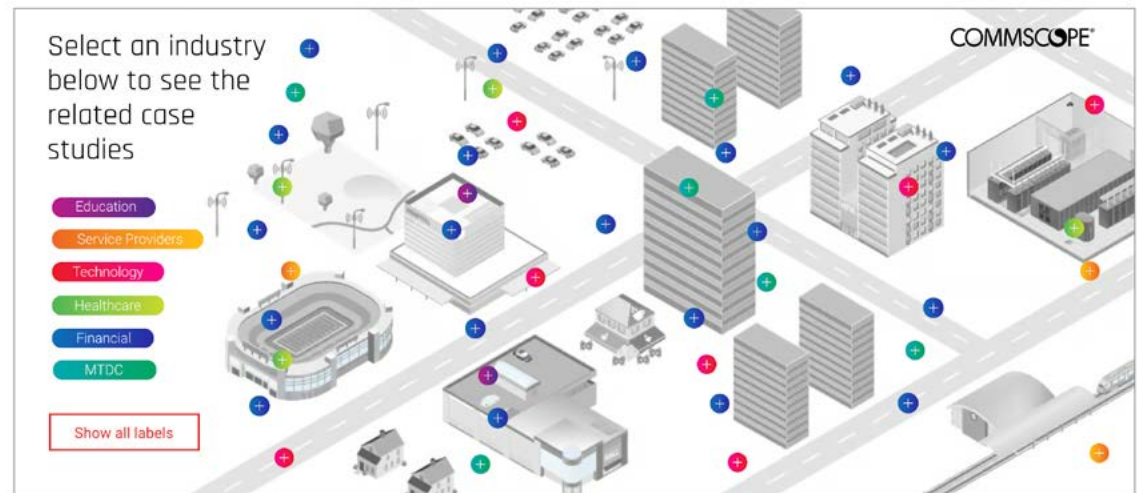

#### Direct System Selection Index

FEC	FACT ODF	UMSC	Flex Frame ODF, 19-in. Propel Panels	FOSC 600	19-in. Splice Solutions	Singlemode Fiber Cables	Singlemode Patch Cord, Cable Mgmt Products	Pre-term 19-in. Fiber	Pre-term FACT ODF Fiber	FiberGuide	Copper Category 6A	Powered Fiber	DIN Rail Solutions	Fiber Wall Boxes	2 Post Equipment Racks	imVision®
-----	----------	------	--------------------------------------	----------	-------------------------	-------------------------	--	-----------------------	-------------------------	------------	--------------------	---------------	--------------------	------------------	------------------------	-----------

#### Architecture System Selection Index

##### Colocation Campus and Building Infrastructure

Fiber Entrance, Meet-Me Room	High Fiber Count DC Interconnect	Campus Cabling	Building Cabling	Campus Cabling for Wi-Fi and Security
------------------------------	----------------------------------	----------------	------------------	---------------------------------------

##### Customer Space Cabling Infrastructure

MDA Fiber	EDA Fiber	EDA Copper	FiberGuide Raceway
-----------	-----------	------------	--------------------

##### Reference Designs and Technical Information

MDA Cabinet	MDA Cross-connect 19-in.	MDA Cross-connect FACT ODF	IDF FACT	IDF 19-in.	FEC
-------------	--------------------------	----------------------------	----------	------------	-----



# Colocation Campus and Building Infrastructure

## Overview

Fiber Entrance and Meet-Me Room

High Fiber Count DC Interconnect

Campus Cabling

Building Cabling

Campus Cabling for Wi-Fi and Security





Select a cabling section for more information.

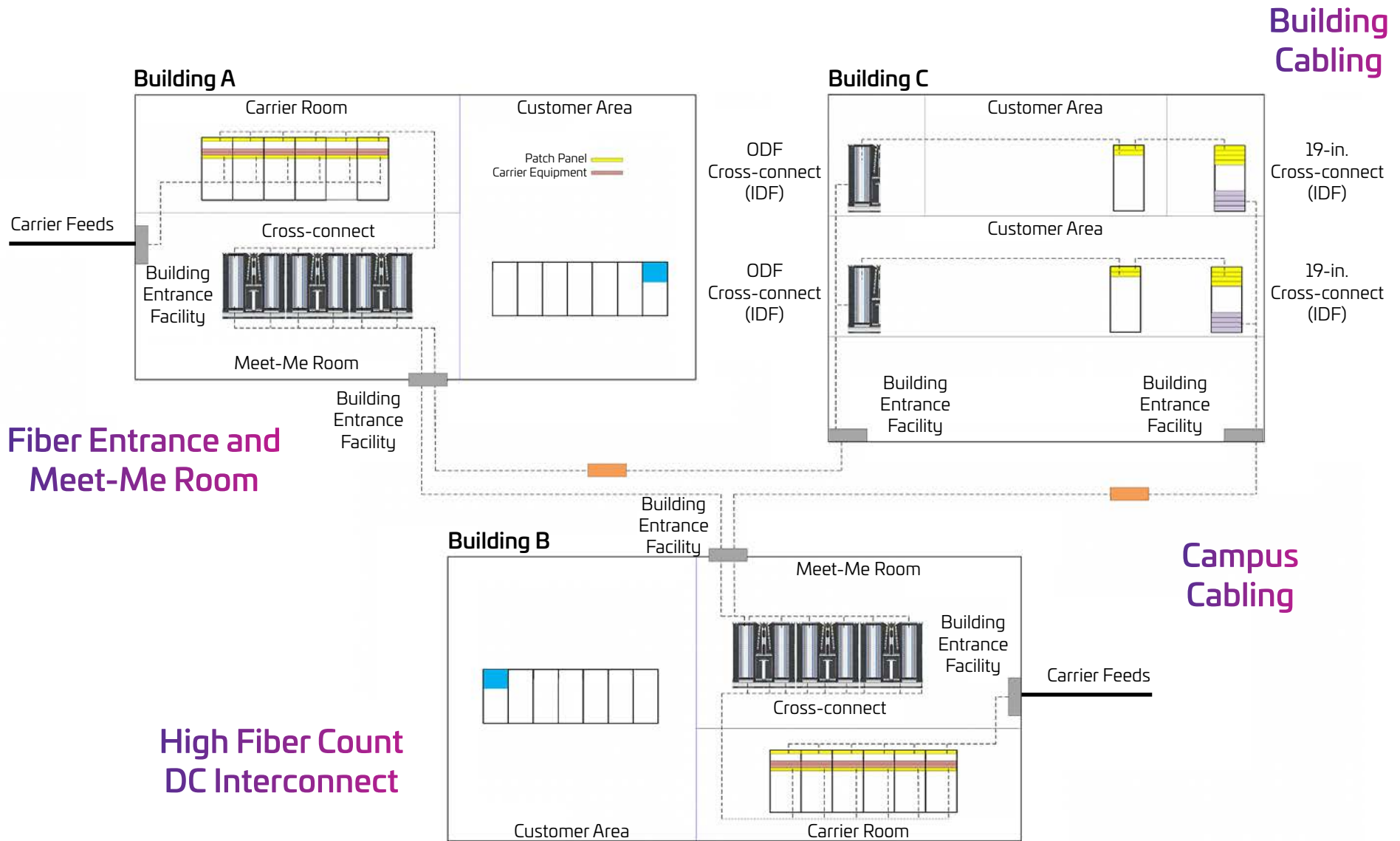

**Fiber Entrance and Meet-Me Room**

**High Fiber Count DC Interconnect**

**Campus Cabling**

**Building Cabling**

## Direct System Selection Index

FEC	FACT ODF	UMSC	Flex Frame ODF, 19-in. Propel Panels	FOSC 600	19-in. Splice Solutions	Singlemode Fiber Cables	Singlemode Patch Cord, Cable Mgmt Products	Pre-term 19-in. Fiber	Pre-term FACT ODF Fiber	FiberGuide	Copper Category 6A	Powered Fiber	DIN Rail Solutions	Fiber Wall Boxes	2 Post Equipment Racks	imVision®
-----	----------	------	--------------------------------------	----------	-------------------------	-------------------------	--	-----------------------	-------------------------	------------	--------------------	---------------	--------------------	------------------	------------------------	-----------

## Architecture System Selection Index

### Colocation Campus and Building Infrastructure

Fiber Entrance, Meet-Me Room	High Fiber Count DC Interconnect	Campus Cabling	Building Cabling	Campus Cabling for Wi-Fi and Security
------------------------------	----------------------------------	----------------	------------------	---------------------------------------

### Customer Space Cabling Infrastructure

MDA Fiber	EDA Fiber	EDA Copper	FiberGuide Raceway
-----------	-----------	------------	--------------------

### Reference Designs and Technical Information

MDA Cabinet	MDA Cross-connect 19-in.	MDA Cross-connect FACT ODF	IDF FACT	IDF 19-in.	FEC
-------------	--------------------------	----------------------------	----------	------------	-----



Select a product for more information.

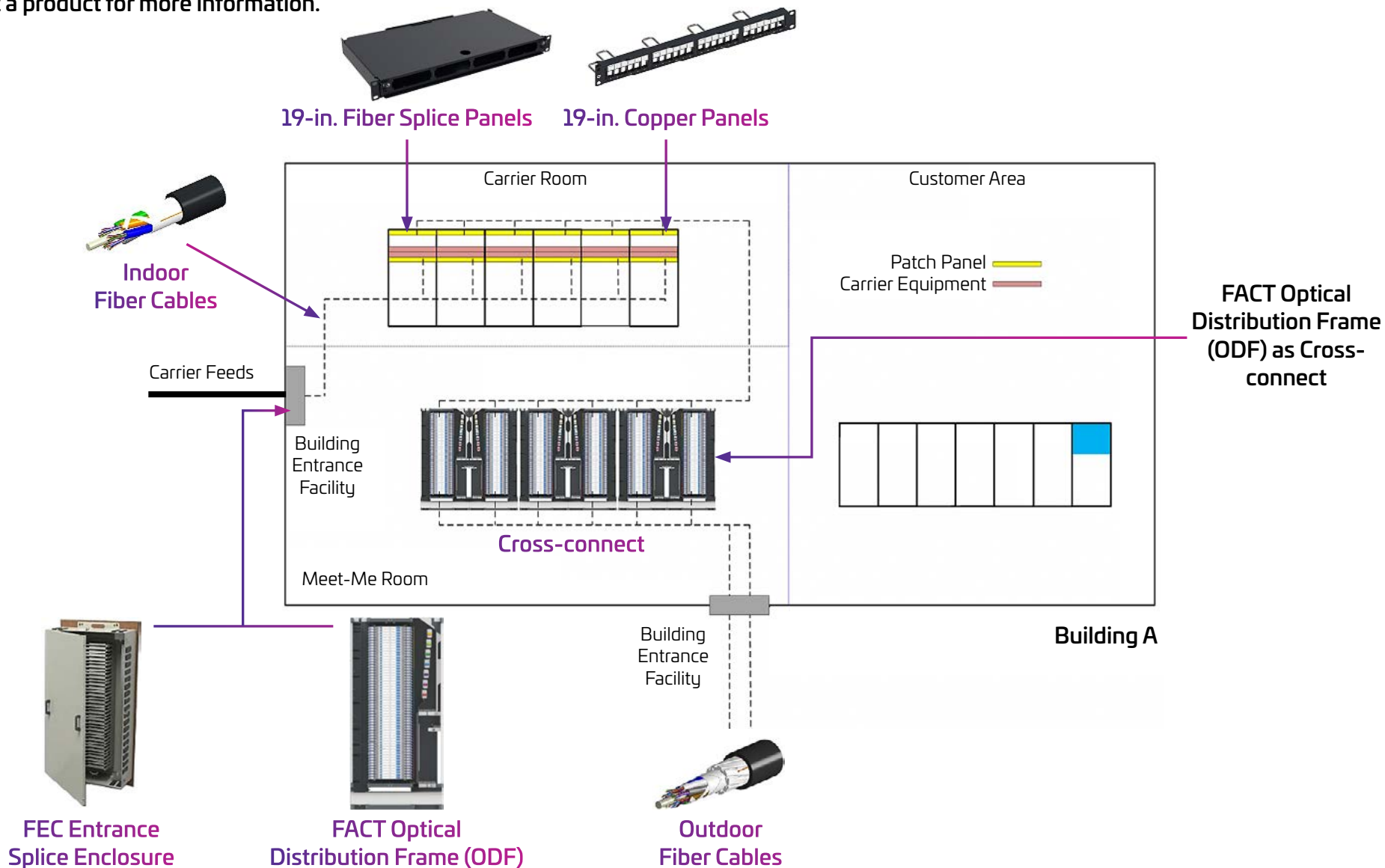

## Direct System Selection Index

FEC	FACT ODF	UMSC	Flex Frame ODF, 19-in. Propel Panels	FOSC 600	19-in. Splice Solutions	Singlemode Fiber Cables	Singlemode Patch Cord, Cable Mgmt Products	Pre-term 19-in. Fiber	Pre-term FACT ODF Fiber	FiberGuide	Copper Category 6A	Powered Fiber	DIN Rail Solutions	Fiber Wall Boxes	2 Post Equipment Racks	imVision®
-----	----------	------	--------------------------------------	----------	-------------------------	-------------------------	--	-----------------------	-------------------------	------------	--------------------	---------------	--------------------	------------------	------------------------	-----------

## Architecture System Selection Index

### Colocation Campus and Building Infrastructure

Fiber Entrance, Meet-Me Room	High Fiber Count DC Interconnect	Campus Cabling	Building Cabling	Campus Cabling for Wi-Fi and Security
------------------------------	----------------------------------	----------------	------------------	---------------------------------------

### Customer Space Cabling Infrastructure

MDA Fiber	EDA Fiber	EDA Copper	FiberGuide Raceway
-----------	-----------	------------	--------------------

### Reference Designs and Technical Information

MDA Cabinet	MDA Cross-connect 19-in.	MDA Cross-connect FACT ODF	IDF FACT	IDF 19-in.	FEC
-------------	--------------------------	----------------------------	----------	------------	-----

Select a product for more information.

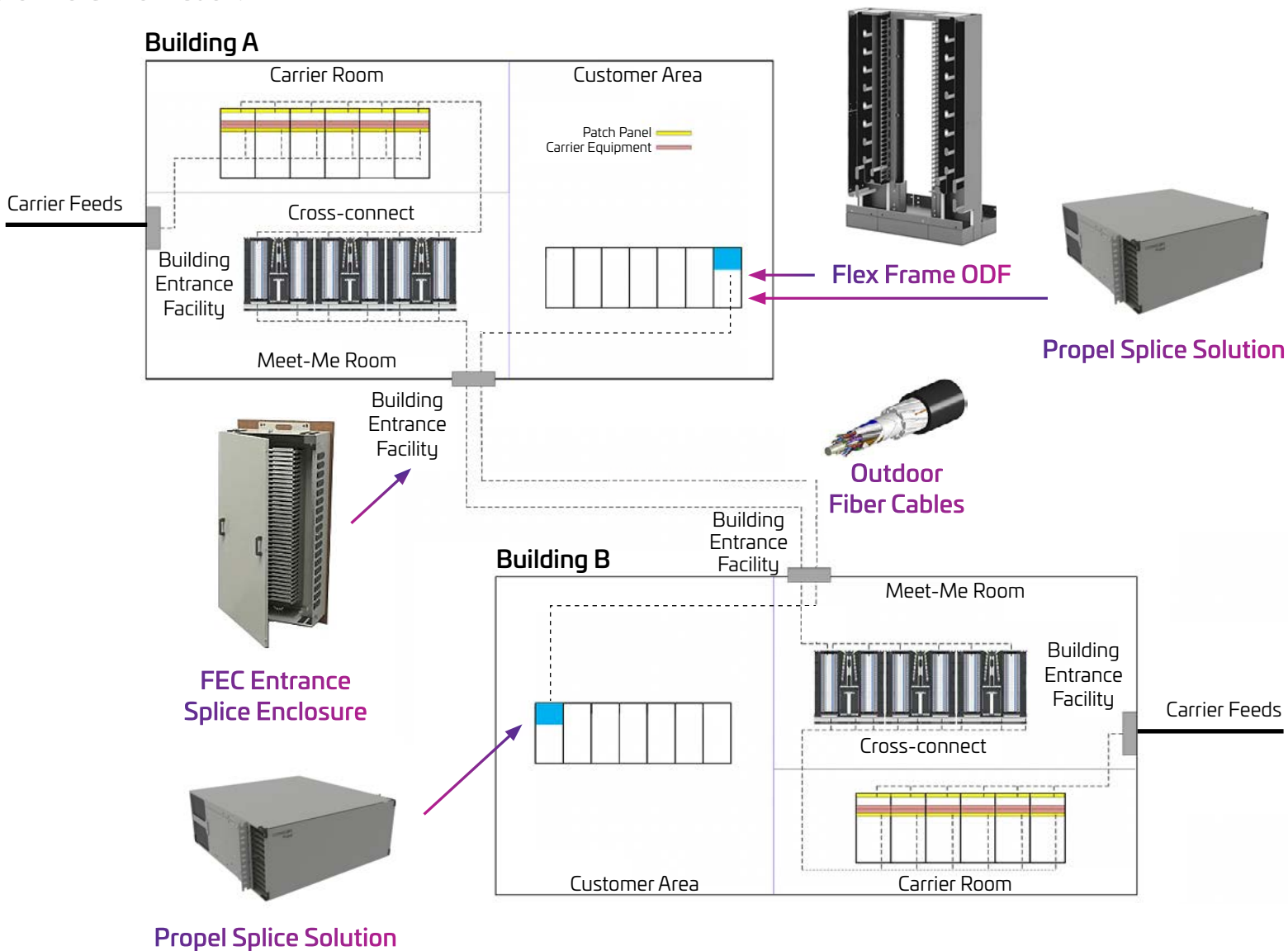

## Direct System Selection Index

FEC	FACT ODF	UMSC	Flex Frame ODF, 19-in. Propel Panels	FOSC 600	19-in. Splice Solutions	Singlemode Fiber Cables	Singlemode Patch Cord, Cable Mgmt Products	Pre-term 19-in. Fiber	Pre-term FACT ODF Fiber	FiberGuide	Copper Category 6A	Powered Fiber	DIN Rail Solutions	Fiber Wall Boxes	2 Post Equipment Racks	imVision®
-----	----------	------	--------------------------------------	----------	-------------------------	-------------------------	--	-----------------------	-------------------------	------------	--------------------	---------------	--------------------	------------------	------------------------	-----------

## Architecture System Selection Index

### Colocation Campus and Building Infrastructure

Fiber Entrance, Meet-Me Room	High Fiber Count DC Interconnect	Campus Cabling	Building Cabling	Campus Cabling for Wi-Fi and Security
------------------------------	----------------------------------	----------------	------------------	---------------------------------------

### Customer Space Cabling Infrastructure

MDA Fiber	EDA Fiber	EDA Copper	FiberGuide Raceway
-----------	-----------	------------	--------------------

### Reference Designs and Technical Information

MDA Cabinet	MDA Cross-connect 19-in.	MDA Cross-connect FACT ODF	IDF FACT	IDF 19-in.	FEC
-------------	--------------------------	----------------------------	----------	------------	-----

Select a product for more information.

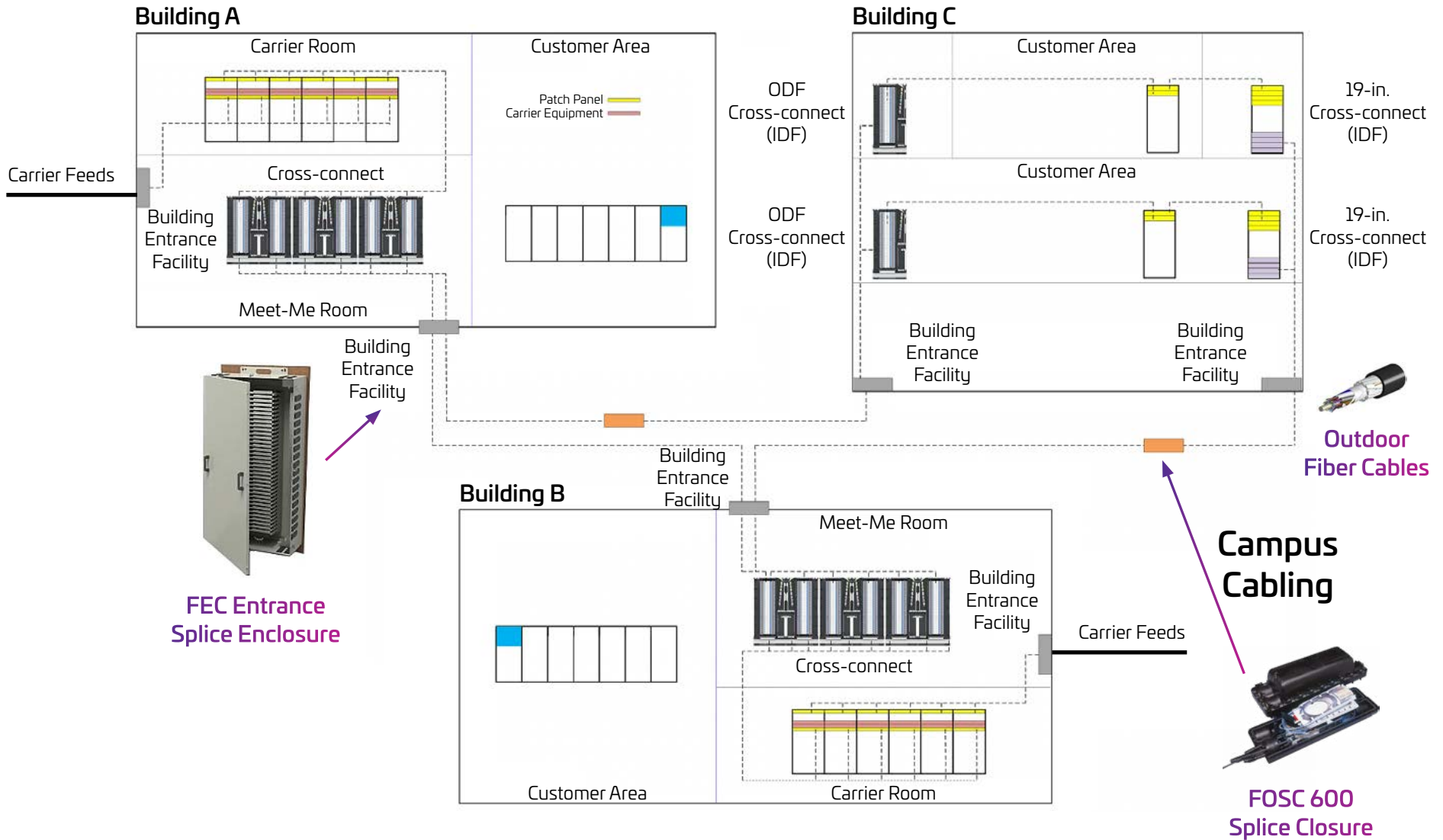

## Direct System Selection Index

FEC	FACT ODF	UMSC	Flex Frame ODF, 19-in. Propel Panels	FOSC 600	19-in. Splice Solutions	Singlemode Fiber Cables	Singlemode Patch Cord, Cable Mgmt Products	Pre-term 19-in. Fiber	Pre-term FACT ODF Fiber	FiberGuide	Copper Category 6A	Powered Fiber	DIN Rail Solutions	Fiber Wall Boxes	2 Post Equipment Racks	imVision®
-----	----------	------	--------------------------------------	----------	-------------------------	-------------------------	--	-----------------------	-------------------------	------------	--------------------	---------------	--------------------	------------------	------------------------	-----------

## Architecture System Selection Index

### Colocation Campus and Building Infrastructure

Fiber Entrance, Meet-Me Room	High Fiber Count DC Interconnect	Campus Cabling	Building Cabling	Campus Cabling for Wi-Fi and Security
------------------------------	----------------------------------	----------------	------------------	---------------------------------------

### Customer Space Cabling Infrastructure

MDA Fiber	EDA Fiber	EDA Copper	FiberGuide Raceway
-----------	-----------	------------	--------------------

### Reference Designs and Technical Information

MDA Cabinet	MDA Cross-connect 19-in.	MDA Cross-connect FACT ODF	IDF FACT	IDF 19-in.	FEC
-------------	--------------------------	----------------------------	----------	------------	-----



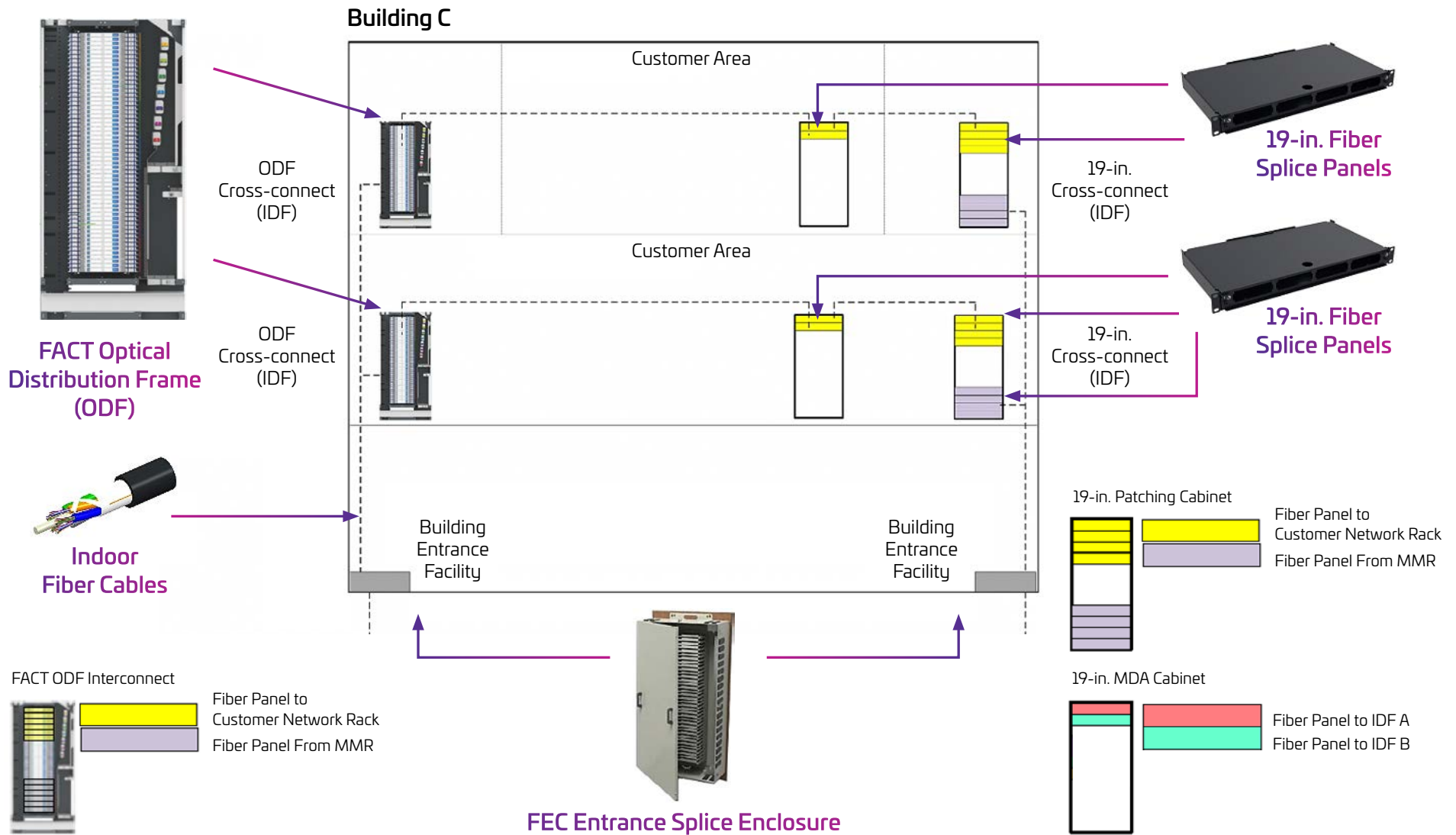

## Direct System Selection Index

FEC	FACT ODF	UMSC	Flex Frame ODF, 19-in. Propel Panels	FOSC 600	19-in. Splice Solutions	Singlemode Fiber Cables	Singlemode Patch Cord, Cable Mgmt Products	Pre-term 19-in. Fiber	Pre-term FACT ODF Fiber	FiberGuide	Copper Category 6A	Powered Fiber	DIN Rail Solutions	Fiber Wall Boxes	2 Post Equipment Racks	imVision®
-----	----------	------	--------------------------------------	----------	-------------------------	-------------------------	--	-----------------------	-------------------------	------------	--------------------	---------------	--------------------	------------------	------------------------	-----------

## Architecture System Selection Index

### Colocation Campus and Building Infrastructure

Fiber Entrance, Meet-Me Room	High Fiber Count DC Interconnect	Campus Cabling	Building Cabling	Campus Cabling for Wi-Fi and Security
------------------------------	----------------------------------	----------------	------------------	---------------------------------------

### Customer Space Cabling Infrastructure

MDA Fiber	EDA Fiber	EDA Copper	FiberGuide Raceway
-----------	-----------	------------	--------------------

### Reference Designs and Technical Information

MDA Cabinet	MDA Cross-connect 19-in.	MDA Cross-connect FACT ODF	IDF FACT	IDF 19-in.	FEC
-------------	--------------------------	----------------------------	----------	------------	-----



Select a product for more information.

## FACT IDF to Customer Cage: Splice Scenario

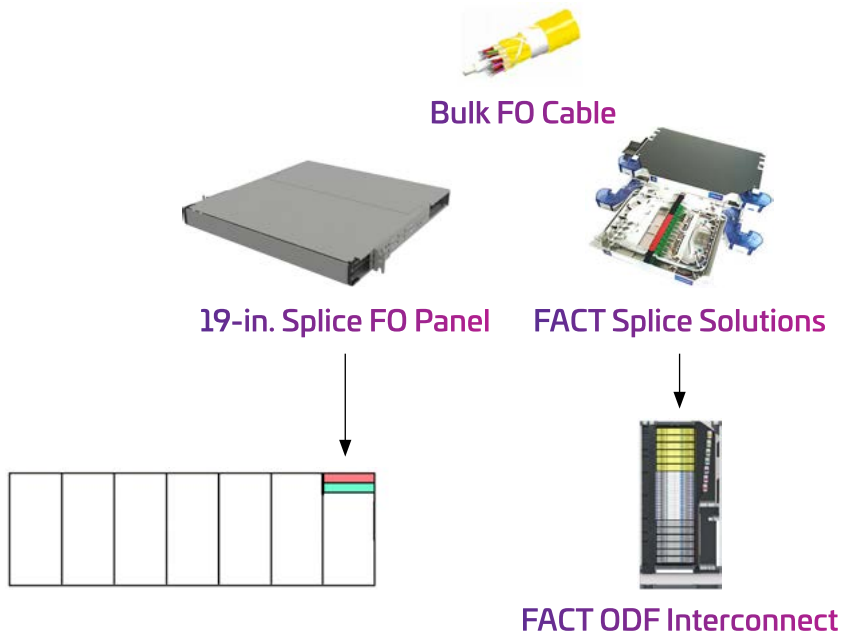

## FACT IDF to Customer Cage: MPO Pre-terminated Scenario

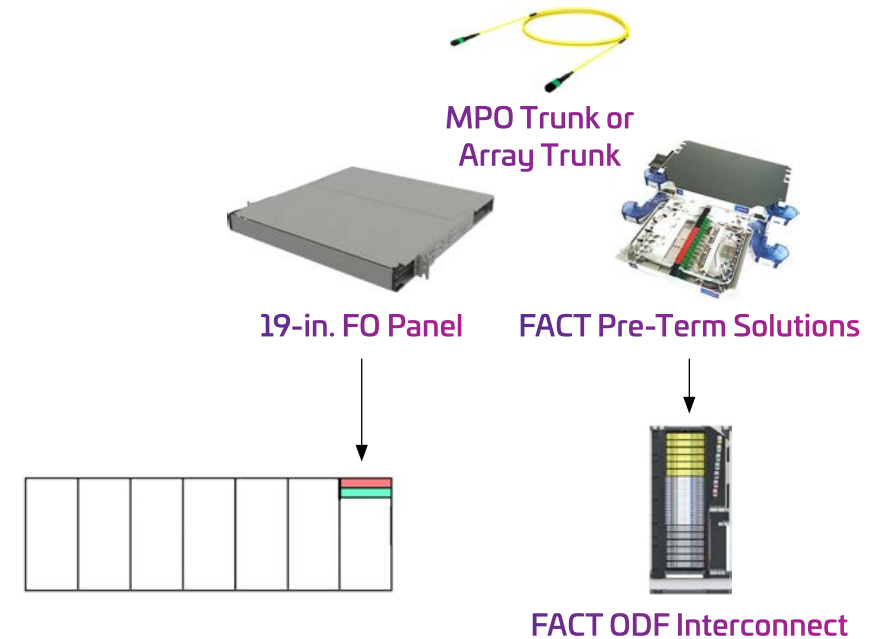

### Direct System Selection Index

FEC	FACT ODF	UMSC	Flex Frame ODF, 19-in. Propel Panels	FOSC 600	19-in. Splice Solutions	Singlemode Fiber Cables	Singlemode Patch Cord, Cable Mgmt Products	Pre-term 19-in. Fiber	Pre-term FACT ODF Fiber	FiberGuide	Copper Category 6A	Powered Fiber	DIN Rail Solutions	Fiber Wall Boxes	2 Post Equipment Racks	imVision®
-----	----------	------	--------------------------------------	----------	-------------------------	-------------------------	--	-----------------------	-------------------------	------------	--------------------	---------------	--------------------	------------------	------------------------	-----------

### Architecture System Selection Index

#### Colocation Campus and Building Infrastructure

Fiber Entrance, Meet-Me Room	High Fiber Count DC Interconnect	Campus Cabling	Building Cabling	Campus Cabling for Wi-Fi and Security
------------------------------	----------------------------------	----------------	------------------	---------------------------------------

#### Customer Space Cabling Infrastructure

MDA Fiber	EDA Fiber	EDA Copper	FiberGuide Raceway
-----------	-----------	------------	--------------------

#### Reference Designs and Technical Information

MDA Cabinet	MDA Cross-connect 19-in.	MDA Cross-connect FACT ODF	IDF FACT	IDF 19-in.	FEC
-------------	--------------------------	----------------------------	----------	------------	-----



Select a product for more information.

## 19-in. IDF to Customer Cage: Splice Scenario

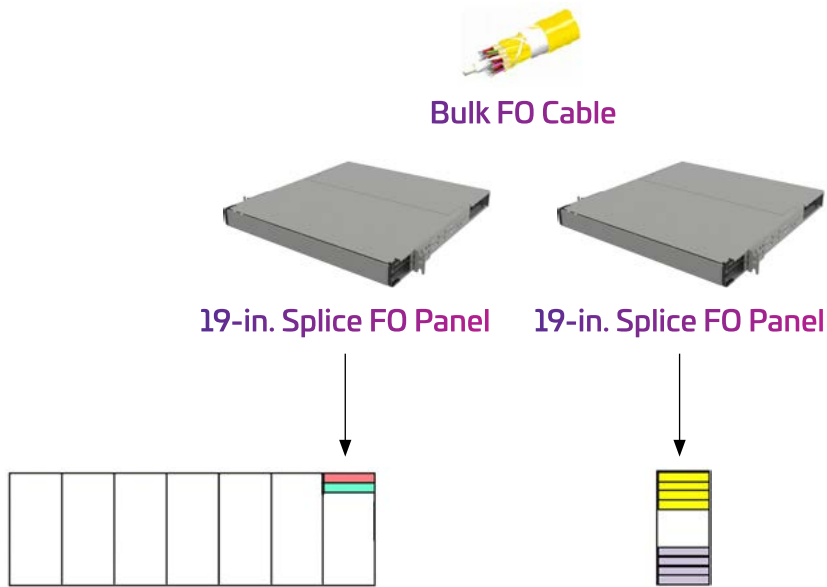

## 19-in. IDF to Customer Cage: MPO Pre-terminated Scenario

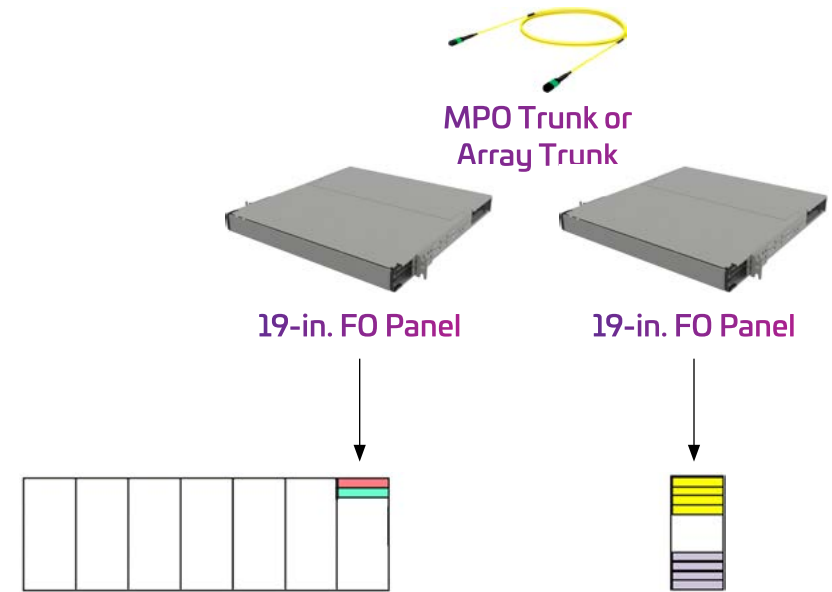

### Direct System Selection Index

FEC	FACT ODF	UMSC	Flex Frame ODF, 19-in. Propel Panels	FOSC 600	19-in. Splice Solutions	Singlemode Fiber Cables	Singlemode Patch Cord, Cable Mgmt Products	Pre-term 19-in. Fiber	Pre-term FACT ODF Fiber	FiberGuide	Copper Category 6A	Powered Fiber	DIN Rail Solutions	Fiber Wall Boxes	2 Post Equipment Racks	imVision®
-----	----------	------	--------------------------------------	----------	-------------------------	-------------------------	--	-----------------------	-------------------------	------------	--------------------	---------------	--------------------	------------------	------------------------	-----------

### Architecture System Selection Index

#### Colocation Campus and Building Infrastructure

Fiber Entrance, Meet-Me Room	High Fiber Count DC Interconnect	Campus Cabling	Building Cabling	Campus Cabling for Wi-Fi and Security
------------------------------	----------------------------------	----------------	------------------	---------------------------------------

#### Customer Space Cabling Infrastructure

MDA Fiber	EDA Fiber	EDA Copper	FiberGuide Raceway
-----------	-----------	------------	--------------------

#### Reference Designs and Technical Information

MDA Cabinet	MDA Cross-connect 19-in.	MDA Cross-connect FACT ODF	IDF FACT	IDF 19-in.	FEC
-------------	--------------------------	----------------------------	----------	------------	-----



Select a product for more information.

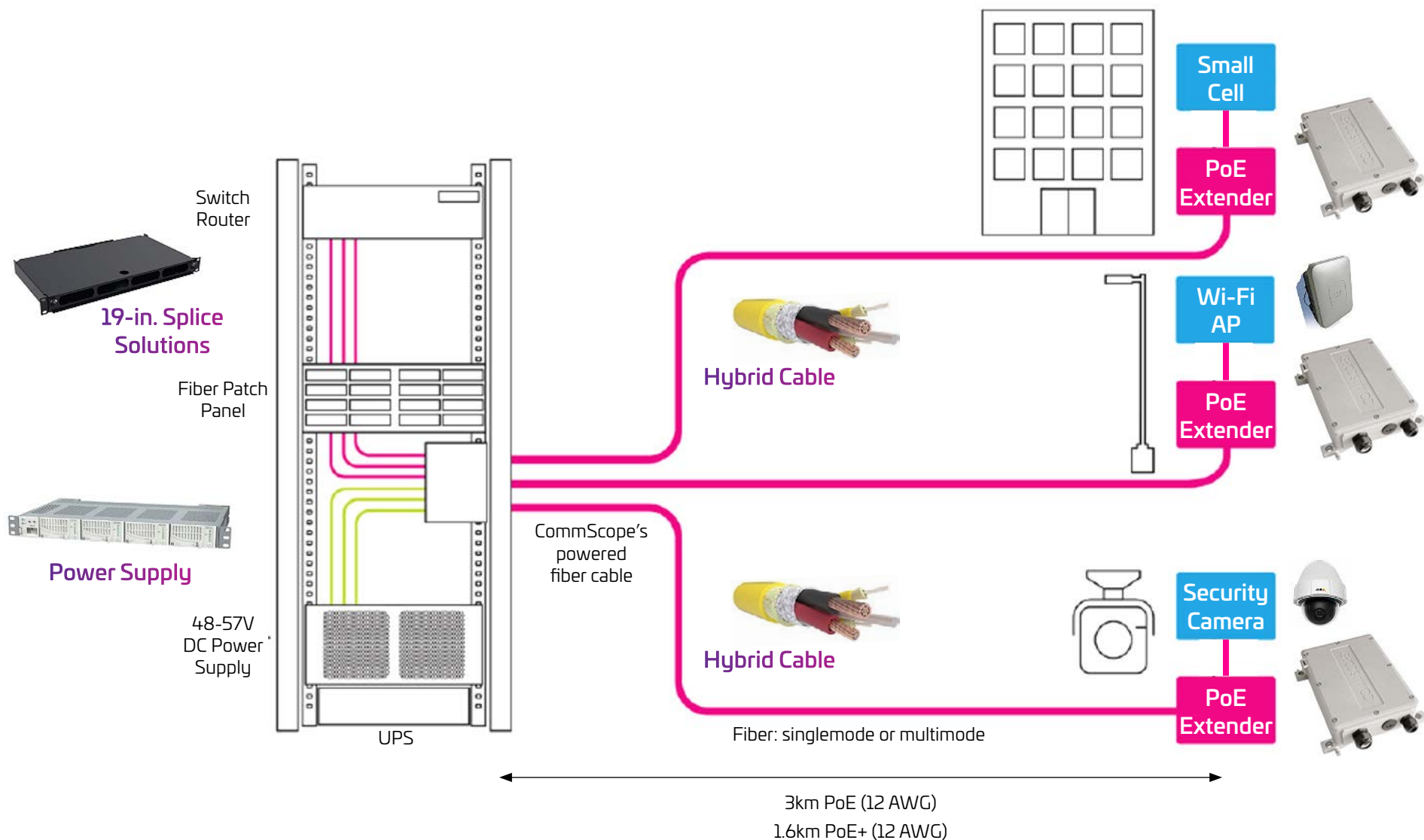

## Direct System Selection Index

FEC	FACT ODF	UMSC	Flex Frame ODF, 19-in. Propel Panels	FOSC 600	19-in. Splice Solutions	Singlemode Fiber Cables	Singlemode Patch Cord, Cable Mgmt Products	Pre-term 19-in. Fiber	Pre-term FACT ODF Fiber	FiberGuide	Copper Category 6A	Powered Fiber	DIN Rail Solutions	Fiber Wall Boxes	2 Post Equipment Racks	imVision®
-----	----------	------	--------------------------------------	----------	-------------------------	-------------------------	--	-----------------------	-------------------------	------------	--------------------	---------------	--------------------	------------------	------------------------	-----------

## Architecture System Selection Index

### Colocation Campus and Building Infrastructure

Fiber Entrance, Meet-Me Room	High Fiber Count DC Interconnect	Campus Cabling	Building Cabling	Campus Cabling for Wi-Fi and Security
------------------------------	----------------------------------	----------------	------------------	---------------------------------------

### Customer Space Cabling Infrastructure

MDA Fiber	EDA Fiber	EDA Copper	FiberGuide Raceway
-----------	-----------	------------	--------------------

### Reference Designs and Technical Information

MDA Cabinet	MDA Cross-connect 19-in.	MDA Cross-connect FACT ODF	IDF FACT	IDF 19-in.	FEC
-------------	--------------------------	----------------------------	----------	------------	-----





# Customer Space Cabling Infrastructure

Main Distribution Area (MDA) Fiber  
Equipment Distribution Area (EDA) Fiber  
Equipment Distribution Area (EDA) Copper  
FiberGuide Raceway Systems



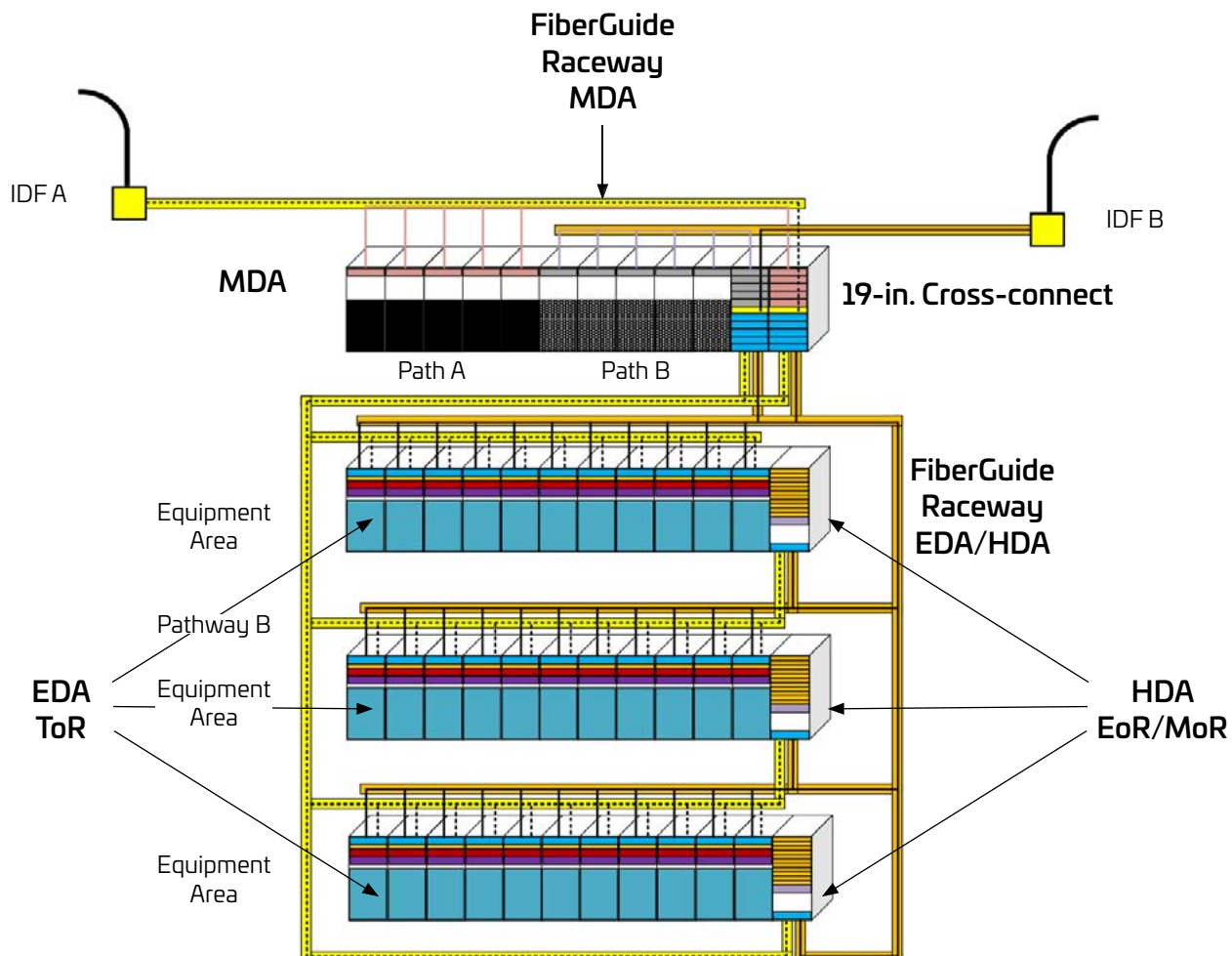
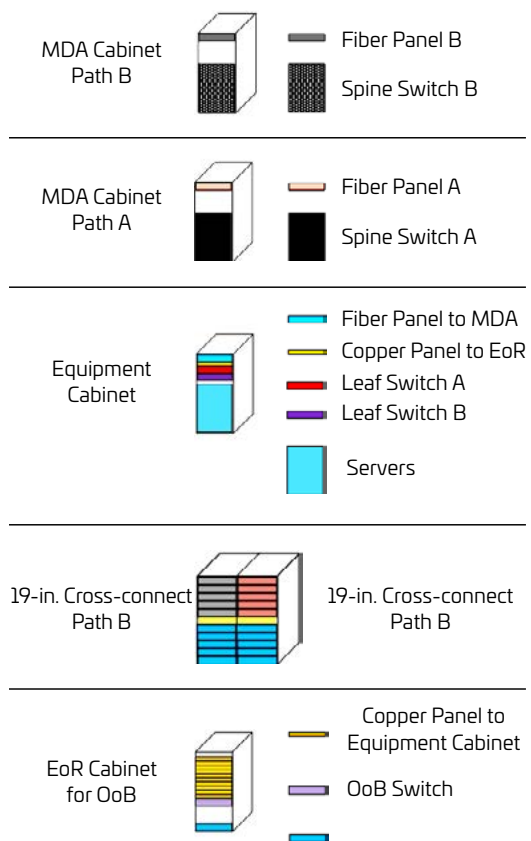

## Direct System Selection Index

FEC	FACT ODF	UMSC	Flex Frame ODF, 19-in. Propel Panels	FOSC 600	19-in. Splice Solutions	Singlemode Fiber Cables	Singlemode Patch Cord, Cable Mgmt Products	Pre-term 19-in. Fiber	Pre-term FACT ODF Fiber	FiberGuide	Copper Category 6A	Powered Fiber	DIN Rail Solutions	Fiber Wall Boxes	2 Post Equipment Racks	imVision®
-----	----------	------	--------------------------------------	----------	-------------------------	-------------------------	--	-----------------------	-------------------------	------------	--------------------	---------------	--------------------	------------------	------------------------	-----------

## Architecture System Selection Index

### Colocation Campus and Building Infrastructure

Fiber Entrance, Meet-Me Room	High Fiber Count DC Interconnect	Campus Cabling	Building Cabling	Campus Cabling for Wi-Fi and Security
------------------------------	----------------------------------	----------------	------------------	---------------------------------------

### Customer Space Cabling Infrastructure

MDA Fiber	EDA Fiber	EDA Copper	FiberGuide Raceway
-----------	-----------	------------	--------------------

### Reference Designs and Technical Information

MDA Cabinet	MDA Cross-connect 19-in.	MDA Cross-connect FACT ODF	IDF FACT	IDF 19-in.	FEC
-------------	--------------------------	----------------------------	----------	------------	-----

Select a product for more information.

## MDA Cabling Channel 19-in. XC

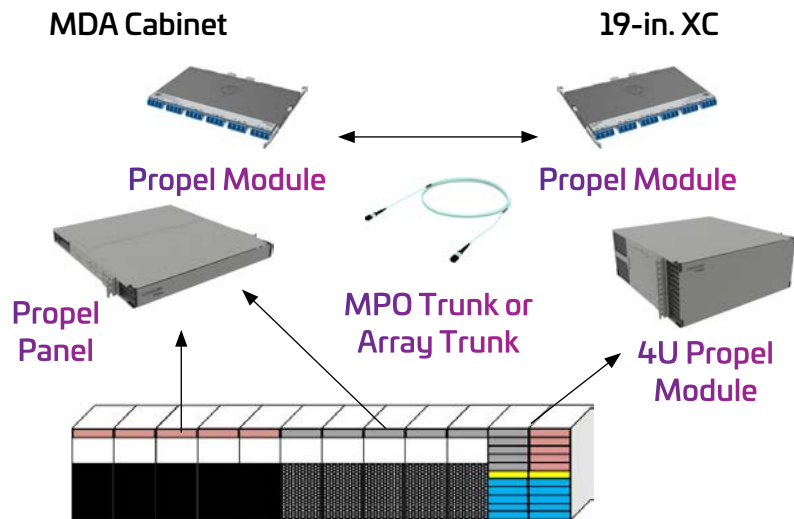

## MDA Cabling Channel ODF XC

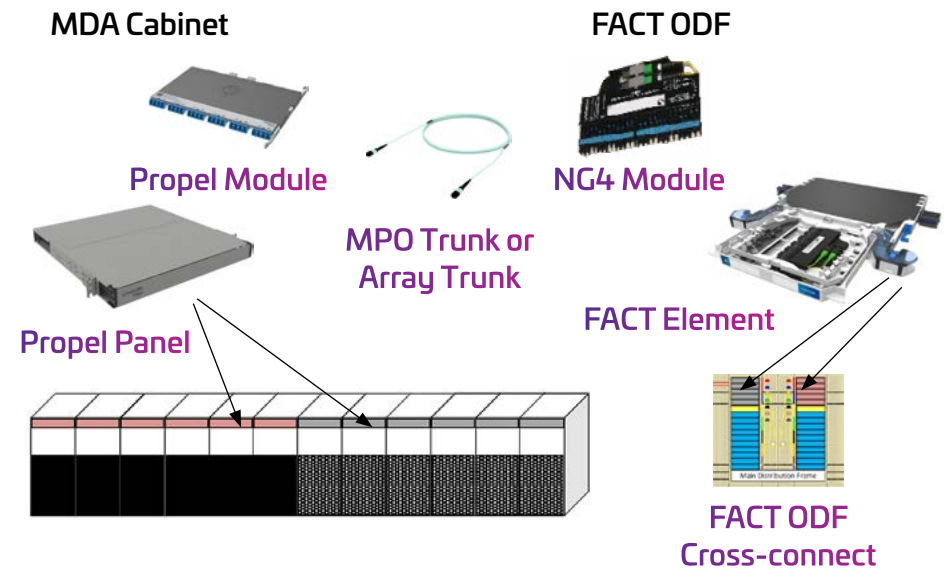

### Direct System Selection Index

FEC	FACT ODF	UMSC	Flex Frame ODF, 19-in. Propel Panels	FOSC 600	19-in. Splice Solutions	Singlemode Fiber Cables	Singlemode Patch Cord, Cable Mgmt Products	Pre-term 19-in. Fiber	Pre-term FACT ODF Fiber	FiberGuide	Copper Category 6A	Powered Fiber	DIN Rail Solutions	Fiber Wall Boxes	2 Post Equipment Racks	imVision®
-----	----------	------	--------------------------------------	----------	-------------------------	-------------------------	--	-----------------------	-------------------------	------------	--------------------	---------------	--------------------	------------------	------------------------	-----------

### Architecture System Selection Index

#### Colocation Campus and Building Infrastructure

Fiber Entrance, Meet-Me Room	High Fiber Count DC Interconnect	Campus Cabling	Building Cabling	Campus Cabling for Wi-Fi and Security
------------------------------	----------------------------------	----------------	------------------	---------------------------------------

#### Customer Space Cabling Infrastructure

MDA Fiber	EDA Fiber	EDA Copper	FiberGuide Raceway
-----------	-----------	------------	--------------------

#### Reference Designs and Technical Information

MDA Cabinet	MDA Cross-connect 19-in.	MDA Cross-connect FACT ODF	IDF FACT	IDF 19-in.	FEC
-------------	--------------------------	----------------------------	----------	------------	-----



Select a product for more information.

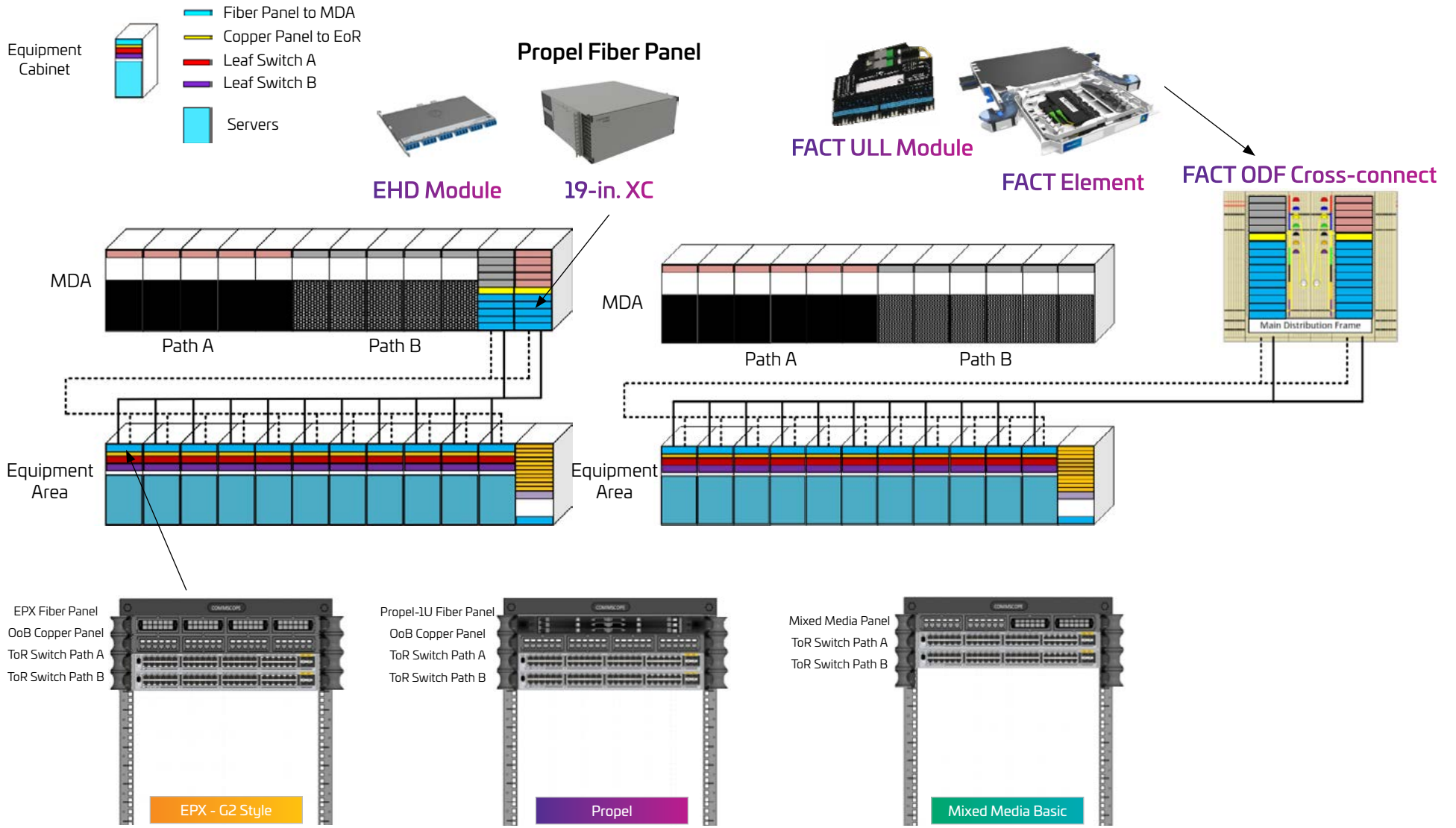

## Direct System Selection Index

FEC	FACT ODF	UMSC	Flex Frame ODF, 19-in. Propel Panels	FOSC 600	19-in. Splice Solutions	Singlemode Fiber Cables	Singlemode Patch Cord, Cable Mgmt Products	Pre-term 19-in. Fiber	Pre-term FACT ODF Fiber	FiberGuide	Copper Category 6A	Powered Fiber	DIN Rail Solutions	Fiber Wall Boxes	2 Post Equipment Racks	imVision®
-----	----------	------	--------------------------------------	----------	-------------------------	-------------------------	--	-----------------------	-------------------------	------------	--------------------	---------------	--------------------	------------------	------------------------	-----------

## Architecture System Selection Index

### Colocation Campus and Building Infrastructure

Fiber Entrance, Meet-Me Room	High Fiber Count DC Interconnect	Campus Cabling	Building Cabling	Campus Cabling for Wi-Fi and Security
------------------------------	----------------------------------	----------------	------------------	---------------------------------------

### Customer Space Cabling Infrastructure

MDA Fiber	EDA Fiber	EDA Copper	FiberGuide Raceway
-----------	-----------	------------	--------------------

### Reference Designs and Technical Information

MDA Cabinet	MDA Cross-connect 19-in.	MDA Cross-connect FACT ODF	IDF FACT	IDF 19-in.	FEC
-------------	--------------------------	----------------------------	----------	------------	-----



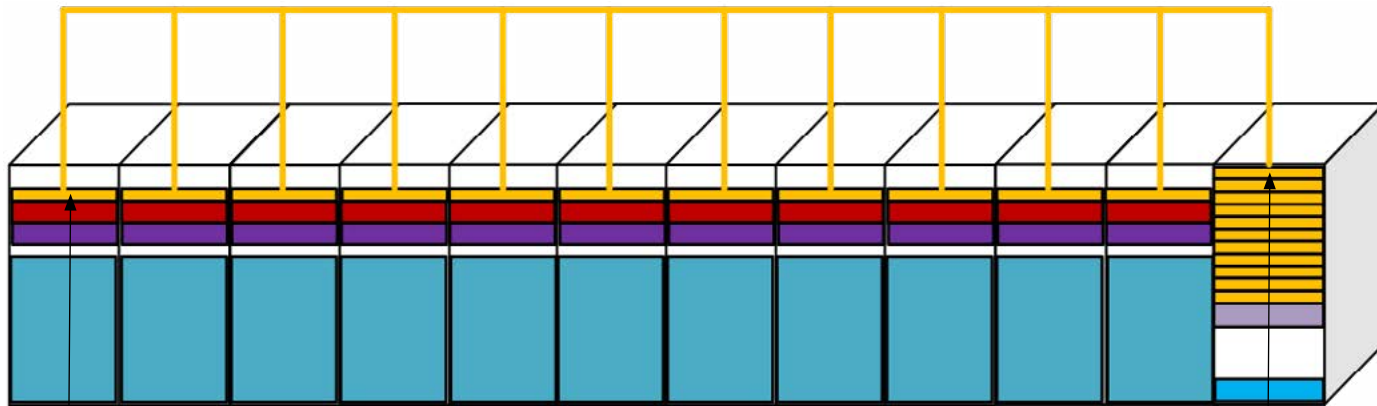
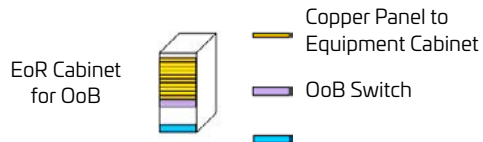

## Direct System Selection Index

FEC	FACT ODF	UMSC	Flex Frame ODF, 19-in. Propel Panels	FOSC 600	19-in. Splice Solutions	Singlemode Fiber Cables	Singlemode Patch Cord, Cable Mgmt Products	Pre-term 19-in. Fiber	Pre-term FACT ODF Fiber	FiberGuide	Copper Category 6A	Powered Fiber	DIN Rail Solutions	Fiber Wall Boxes	2 Post Equipment Racks	imVision®
-----	----------	------	--------------------------------------	----------	-------------------------	-------------------------	--	-----------------------	-------------------------	------------	--------------------	---------------	--------------------	------------------	------------------------	-----------

## Architecture System Selection Index

### Colocation Campus and Building Infrastructure

Fiber Entrance, Meet-Me Room	High Fiber Count DC Interconnect	Campus Cabling	Building Cabling	Campus Cabling for Wi-Fi and Security
------------------------------	----------------------------------	----------------	------------------	---------------------------------------

### Customer Space Cabling Infrastructure

MDA Fiber	EDA Fiber	EDA Copper	FiberGuide Raceway
-----------	-----------	------------	--------------------

### Reference Designs and Technical Information

MDA Cabinet	MDA Cross-connect 19-in.	MDA Cross-connect FACT ODF	IDF FACT	IDF 19-in.	FEC
-------------	--------------------------	----------------------------	----------	------------	-----



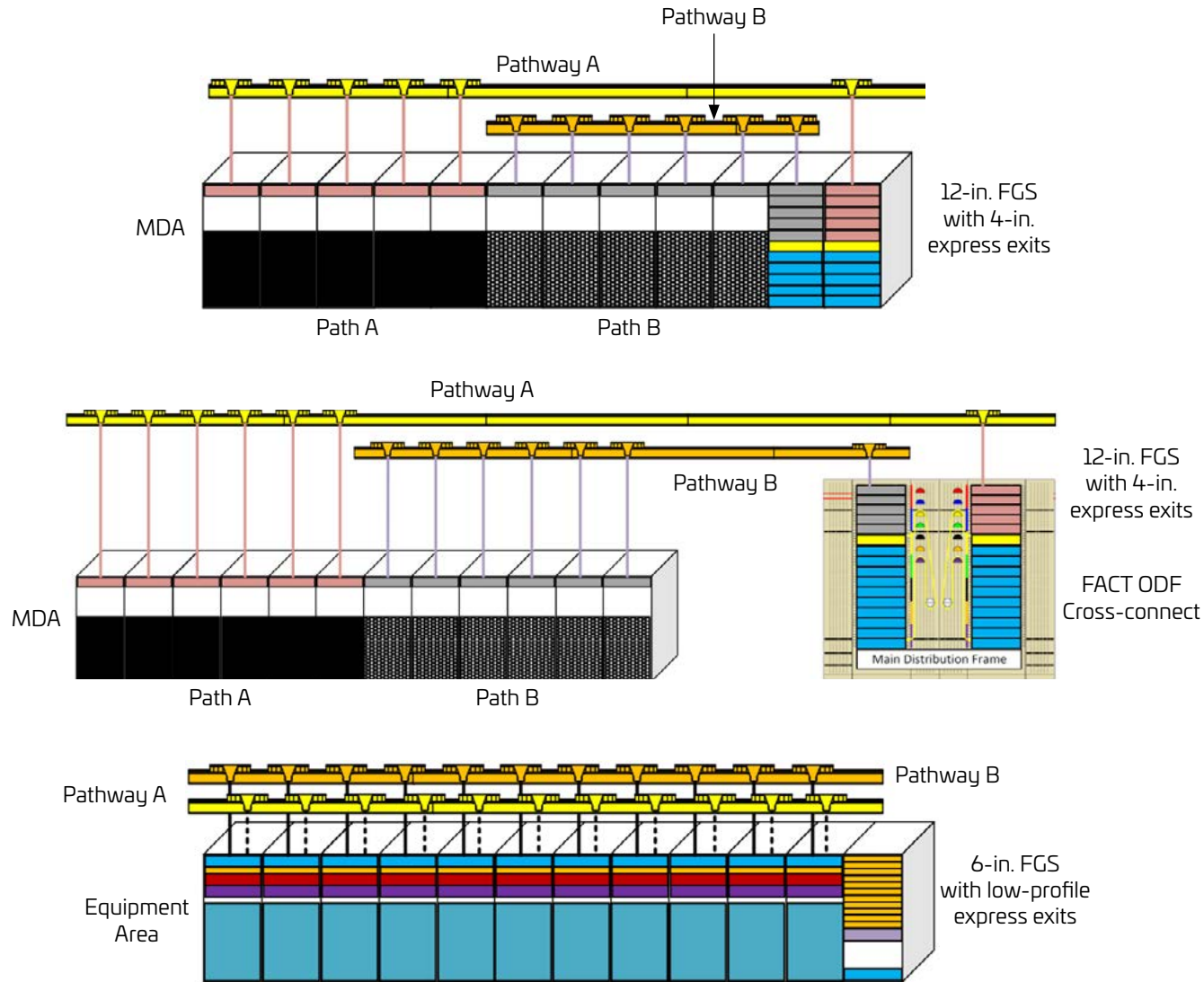

## Direct System Selection Index

FEC	FACT ODF	UMSC	Flex Frame ODF, 19-in. Propel Panels	FOSC 600	19-in. Splice Solutions	Singlemode Fiber Cables	Singlemode Patch Cord, Cable Mgmt Products	Pre-term 19-in. Fiber	Pre-term FACT ODF Fiber	FiberGuide	Copper Category 6A	Powered Fiber	DIN Rail Solutions	Fiber Wall Boxes	2 Post Equipment Racks	imVision®
-----	----------	------	--------------------------------------	----------	-------------------------	-------------------------	--	-----------------------	-------------------------	------------	--------------------	---------------	--------------------	------------------	------------------------	-----------

## Architecture System Selection Index

### Colocation Campus and Building Infrastructure

Fiber Entrance, Meet-Me Room	High Fiber Count DC Interconnect	Campus Cabling	Building Cabling	Campus Cabling for Wi-Fi and Security
------------------------------	----------------------------------	----------------	------------------	---------------------------------------

### Customer Space Cabling Infrastructure

MDA Fiber	EDA Fiber	EDA Copper	FiberGuide Raceway
-----------	-----------	------------	--------------------

### Reference Designs and Technical Information

MDA Cabinet	MDA Cross-connect 19-in.	MDA Cross-connect FACT ODF	IDF FACT	IDF 19-in.	FEC
-------------	--------------------------	----------------------------	----------	------------	-----



# Reference Designs and Technical Information

MDA Cabinet

MDA Cross-connect 19-in.

MDA Cross-connect FACT ODF

IDF FACT

IDF 19-in.

Fiber Entrance Cabinet (FEC)



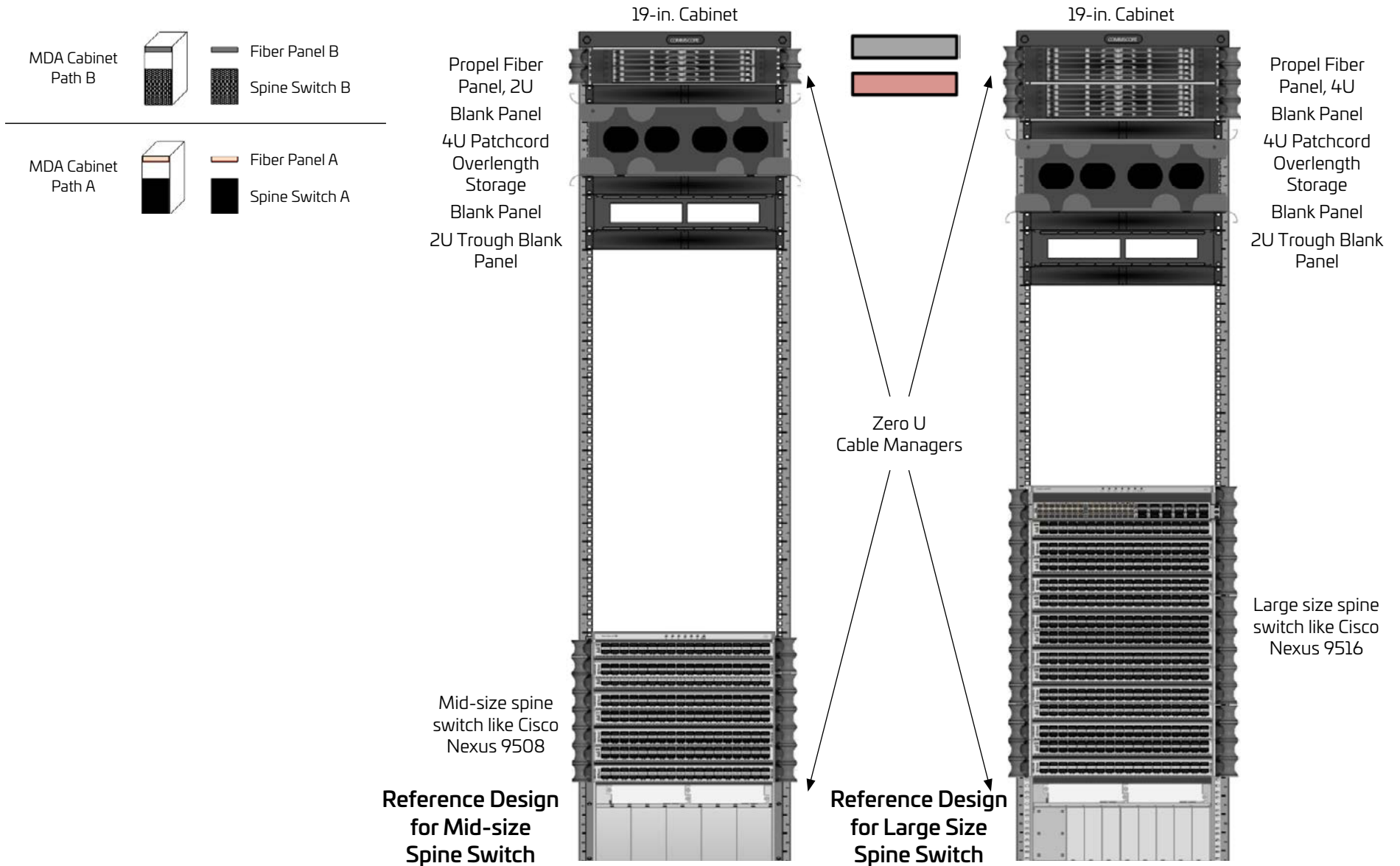

Direct System Selection Index

FEC	FACT ODF	UMSC	Flex Frame ODF, 19-in. Propel Panels	FOSC 600	19-in. Splice Solutions	Singlemode Fiber Cables	Singlemode Patch Cord, Cable Mgmt Products	Pre-term 19-in. Fiber	Pre-term FACT ODF Fiber	FiberGuide	Copper Category 6A	Powered Fiber	DIN Rail Solutions	Fiber Wall Boxes	2 Post Equipment Racks	imVision®
-----	----------	------	--------------------------------------	----------	-------------------------	-------------------------	--	-----------------------	-------------------------	------------	--------------------	---------------	--------------------	------------------	------------------------	-----------

Architecture System Selection Index

Colocation Campus and Building Infrastructure

Fiber Entrance, Meet-Me Room	High Fiber Count DC Interconnect	Campus Cabling	Building Cabling	Campus Cabling for Wi-Fi and Security
------------------------------	----------------------------------	----------------	------------------	---------------------------------------

Customer Space Cabling Infrastructure

MDA Fiber	EDA Fiber	EDA Copper	FiberGuide Raceway
-----------	-----------	------------	--------------------

Reference Designs and Technical Information

MDA Cabinet	MDA Cross-connect 19-in.	MDA Cross-connect FACT ODF	IDF FACT	IDF 19-in.	FEC
-------------	--------------------------	----------------------------	----------	------------	-----





19-in. Cross-connect Path B



19-in. Cross-connect Path B

19-in. Cabinet

3x Propel Fiber Panels, 4U  
Patch section 1

Blank Panel

Overlength Storage 4U

Blank Panel

3x Propel Fiber Panels, 4U  
Patch Section 2

Blank Panel

Overlength Storage 4U

Blank Panel

Cable Trough 2U to guide patch cords to adjacent cabinets

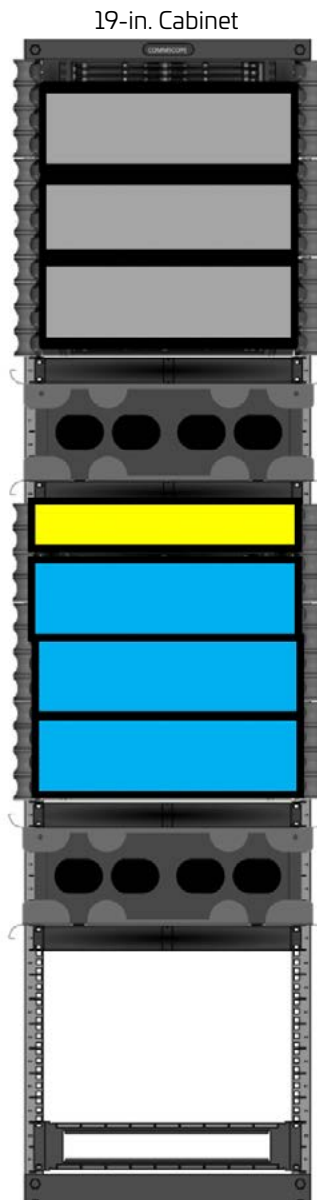

19-in. Cabinet

3x Propel Fiber Panels, 4U  
Patch section 1

Blank Panel

Overlength Storage 4U

Blank Panel

3x Propel Fiber Panels, 4U  
Patch Section 2

Blank Panel

Overlength Storage 4U

Blank Panel

Cable Trough 2U to guide patch cords to adjacent cabinets

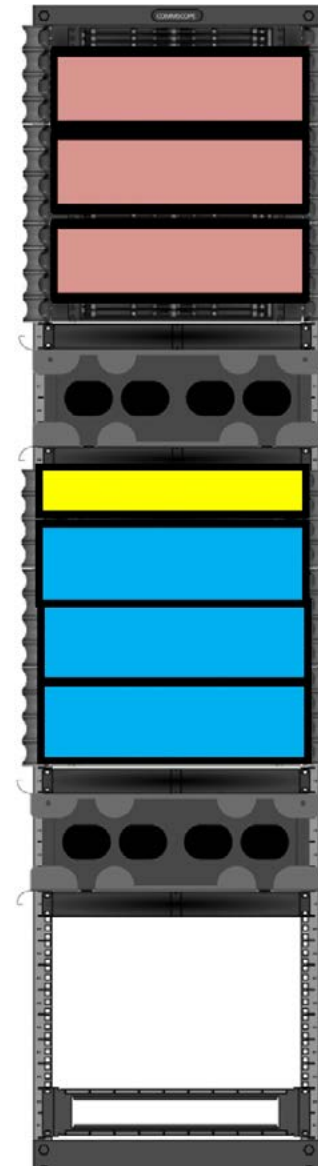

## Direct System Selection Index

FEC	FACT ODF	UMSC	Flex Frame ODF, 19-in. Propel Panels	FOSC 600	19-in. Splice Solutions	Singlemode Fiber Cables	Singlemode Patch Cord, Cable Mgmt Products	Pre-term 19-in. Fiber	Pre-term FACT ODF Fiber	FiberGuide	Copper Category 6A	Powered Fiber	DIN Rail Solutions	Fiber Wall Boxes	2 Post Equipment Racks	imVision®
-----	----------	------	--------------------------------------	----------	-------------------------	-------------------------	--	-----------------------	-------------------------	------------	--------------------	---------------	--------------------	------------------	------------------------	-----------

## Architecture System Selection Index

### Colocation Campus and Building Infrastructure

Fiber Entrance, Meet-Me Room	High Fiber Count DC Interconnect	Campus Cabling	Building Cabling	Campus Cabling for Wi-Fi and Security
------------------------------	----------------------------------	----------------	------------------	---------------------------------------

### Customer Space Cabling Infrastructure

MDA Fiber	EDA Fiber	EDA Copper	FiberGuide Raceway
-----------	-----------	------------	--------------------

### Reference Designs and Technical Information

MDA Cabinet	MDA Cross-connect 19-in.	MDA Cross-connect FACT ODF	IDF FACT	IDF 19-in.	FEC
-------------	--------------------------	----------------------------	----------	------------	-----



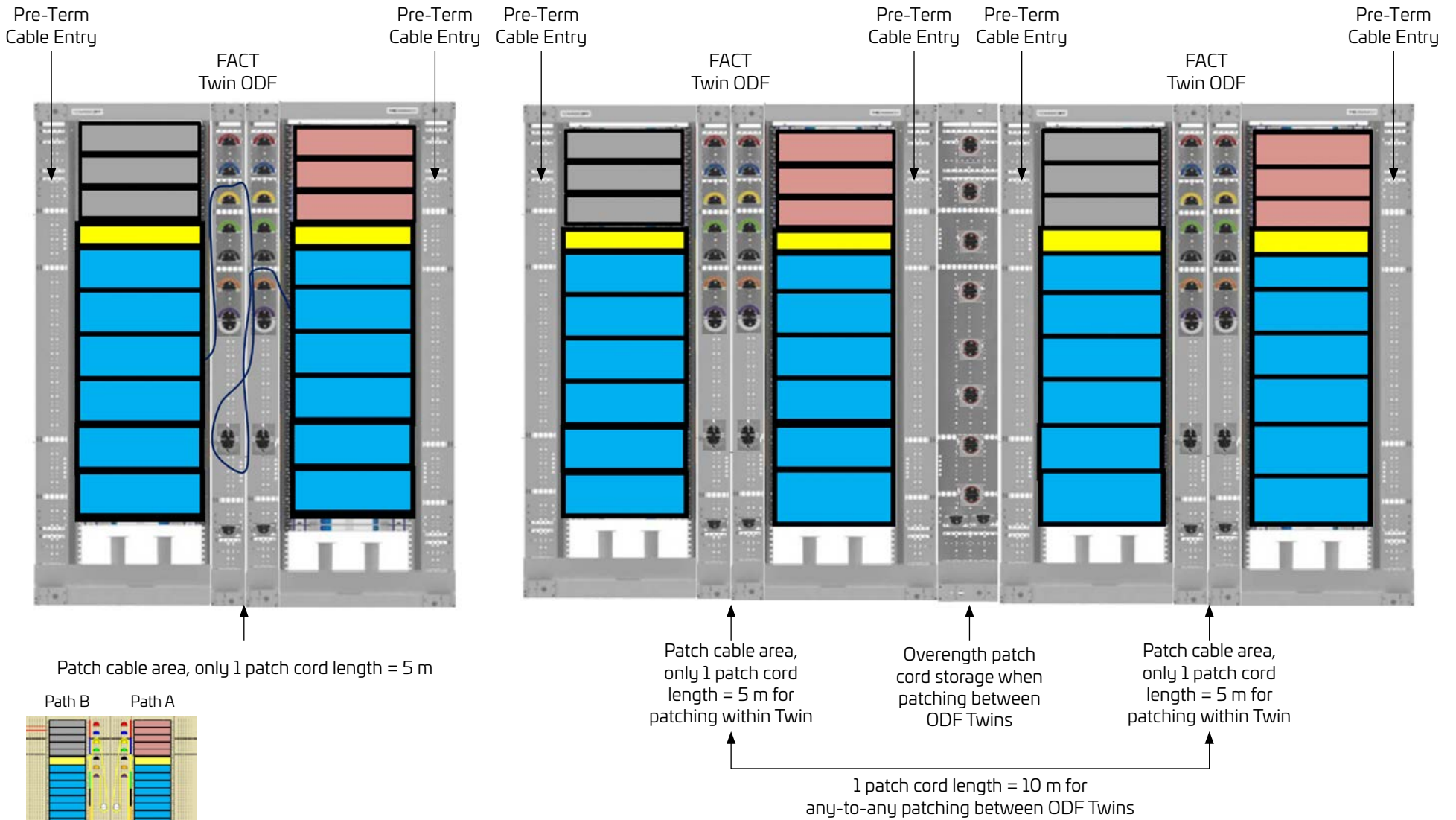

Note: The XC can consist of more than 4 cabinets depending on the DC size.

## Direct System Selection Index

FEC	FACT ODF	UMSC	Flex Frame ODF, 19-in. Propel Panels	FOSC 600	19-in. Splice Solutions	Singlemode Fiber Cables	Singlemode Patch Cord, Cable Mgmt Products	Pre-term 19-in. Fiber	Pre-term FACT ODF Fiber	FiberGuide	Copper Category 6A	Powered Fiber	DIN Rail Solutions	Fiber Wall Boxes	2 Post Equipment Racks	imVision®
-----	----------	------	--------------------------------------	----------	-------------------------	-------------------------	--	-----------------------	-------------------------	------------	--------------------	---------------	--------------------	------------------	------------------------	-----------

## Architecture System Selection Index

### Colocation Campus and Building Infrastructure

Fiber Entrance, Meet-Me Room	High Fiber Count DC Interconnect	Campus Cabling	Building Cabling	Campus Cabling for Wi-Fi and Security
------------------------------	----------------------------------	----------------	------------------	---------------------------------------

### Customer Space Cabling Infrastructure

MDA Fiber	EDA Fiber	EDA Copper	FiberGuide Raceway
-----------	-----------	------------	--------------------

### Reference Designs and Technical Information

MDA Cabinet	MDA Cross-connect 19-in.	MDA Cross-connect FACT ODF	IDF FACT	IDF 19-in.	FEC
-------------	--------------------------	----------------------------	----------	------------	-----



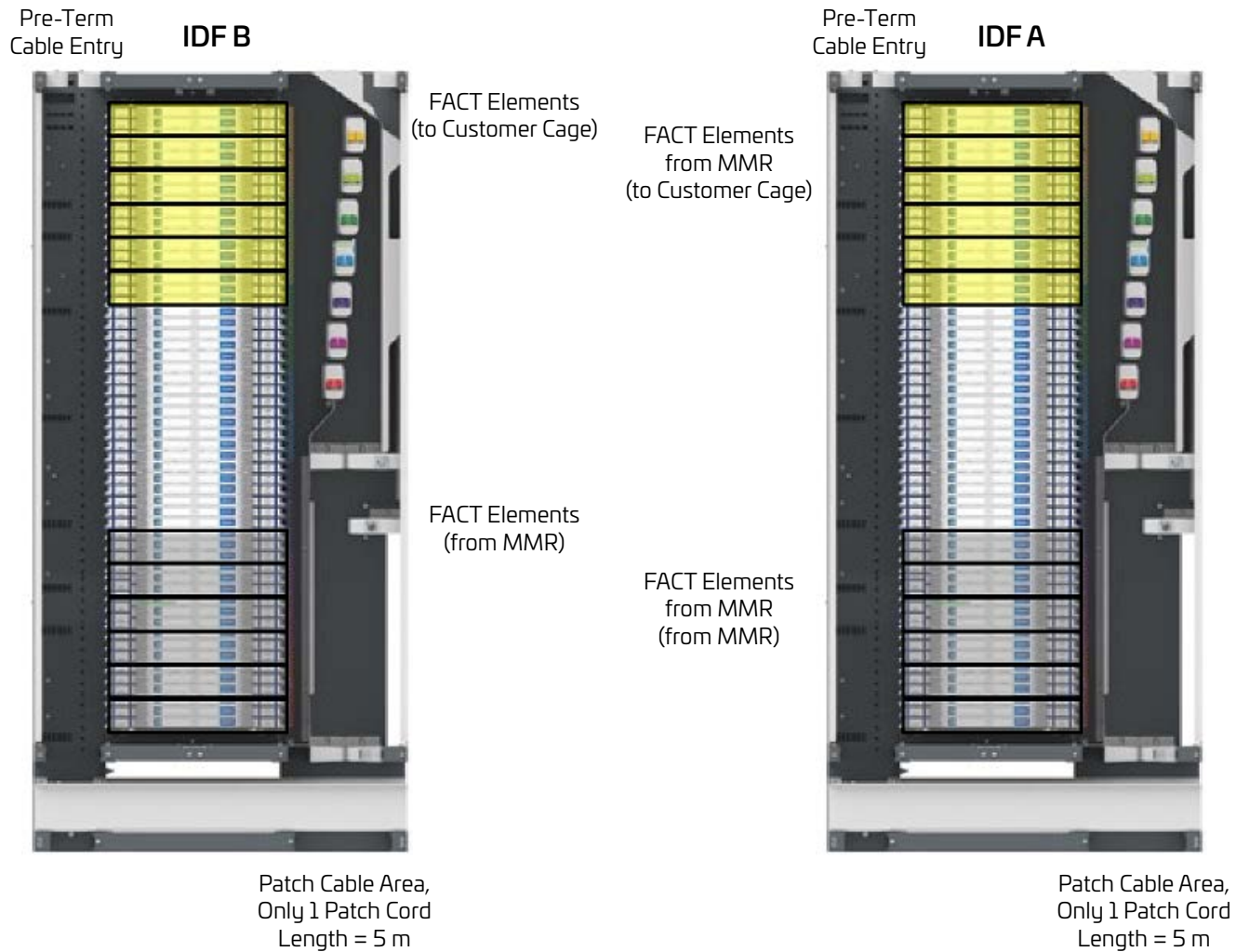

Direct System Selection Index

FEC	FACT ODF	UMSC	Flex Frame ODF, 19-in. Propel Panels	FOSC 600	19-in. Splice Solutions	Singlemode Fiber Cables	Singlemode Patch Cord, Cable Mgmt Products	Pre-term 19-in. Fiber	Pre-term FACT ODF Fiber	FiberGuide	Copper Category 6A	Powered Fiber	DIN Rail Solutions	Fiber Wall Boxes	2 Post Equipment Racks	imVision®
-----	----------	------	--------------------------------------	----------	-------------------------	-------------------------	--	-----------------------	-------------------------	------------	--------------------	---------------	--------------------	------------------	------------------------	-----------

Architecture System Selection Index

Colocation Campus and Building Infrastructure

Fiber Entrance, Meet-Me Room	High Fiber Count DC Interconnect	Campus Cabling	Building Cabling	Campus Cabling for Wi-Fi and Security
------------------------------	----------------------------------	----------------	------------------	---------------------------------------

Customer Space Cabling Infrastructure

MDA Fiber	EDA Fiber	EDA Copper	FiberGuide Raceway
-----------	-----------	------------	--------------------

Reference Designs and Technical Information

MDA Cabinet	MDA Cross-connect 19-in.	MDA Cross-connect FACT ODF	IDF FACT	IDF 19-in.	FEC
-------------	--------------------------	----------------------------	----------	------------	-----



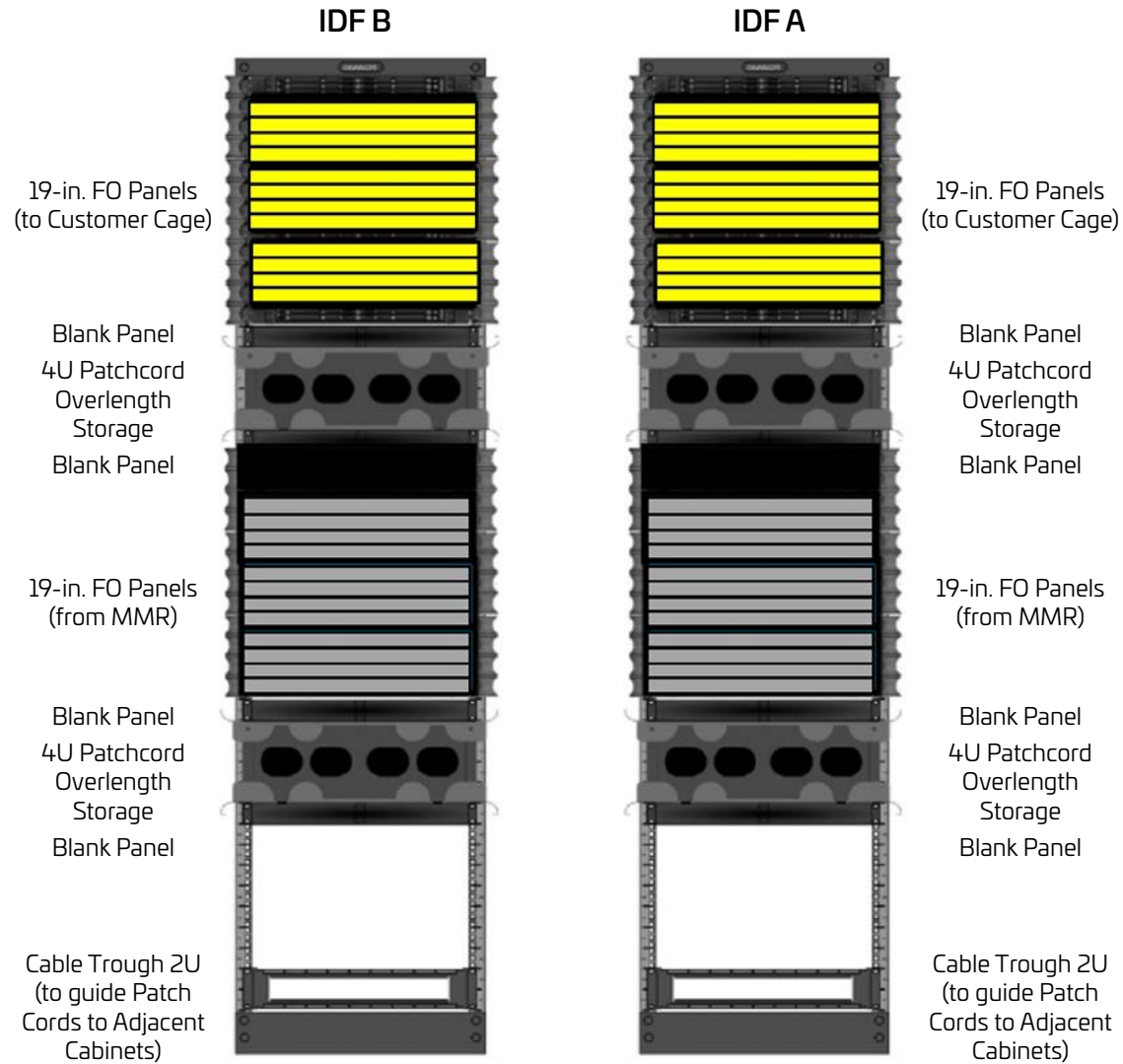
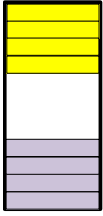

Direct System Selection Index

FEC	FACT ODF	UMSC	Flex Frame ODF, 19-in. Propel Panels	FOSC 600	19-in. Splice Solutions	Singlemode Fiber Cables	Singlemode Patch Cord, Cable Mgmt Products	Pre-term 19-in. Fiber	Pre-term FACT ODF Fiber	FiberGuide	Copper Category 6A	Powered Fiber	DIN Rail Solutions	Fiber Wall Boxes	2 Post Equipment Racks	imVision®
-----	----------	------	--------------------------------------	----------	-------------------------	-------------------------	--	-----------------------	-------------------------	------------	--------------------	---------------	--------------------	------------------	------------------------	-----------

Architecture System Selection Index

Colocation Campus and Building Infrastructure

Fiber Entrance, Meet-Me Room	High Fiber Count DC Interconnect	Campus Cabling	Building Cabling	Campus Cabling for Wi-Fi and Security
------------------------------	----------------------------------	----------------	------------------	---------------------------------------

Customer Space Cabling Infrastructure

MDA Fiber	EDA Fiber	EDA Copper	FiberGuide Raceway
-----------	-----------	------------	--------------------

Reference Designs and Technical Information

MDA Cabinet	MDA Cross-connect 19-in.	MDA Cross-connect FACT ODF	IDF FACT	IDF 19-in.	FEC
-------------	--------------------------	----------------------------	----------	------------	-----



Review the User Manual [here](#).

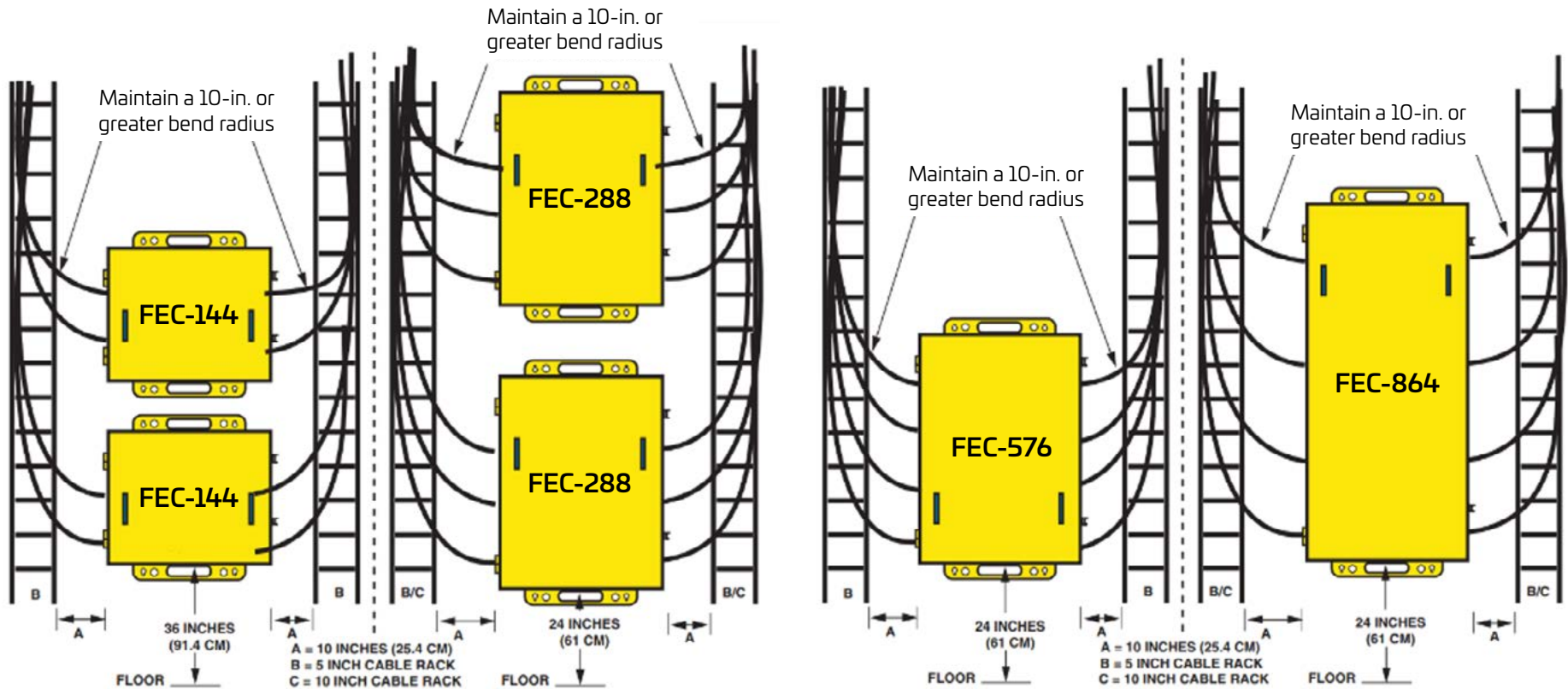

## Direct System Selection Index

FEC	FACT ODF	UMSC	Flex Frame ODF, 19-in. Propel Panels	FOSC 600	19-in. Splice Solutions	Singlemode Fiber Cables	Singlemode Patch Cord, Cable Mgmt Products	Pre-term 19-in. Fiber	Pre-term FACT ODF Fiber	FiberGuide	Copper Category 6A	Powered Fiber	DIN Rail Solutions	Fiber Wall Boxes	2 Post Equipment Racks	imVision®
-----	----------	------	--------------------------------------	----------	-------------------------	-------------------------	--	-----------------------	-------------------------	------------	--------------------	---------------	--------------------	------------------	------------------------	-----------

## Architecture System Selection Index

### Colocation Campus and Building Infrastructure

Fiber Entrance, Meet-Me Room	High Fiber Count DC Interconnect	Campus Cabling	Building Cabling	Campus Cabling for Wi-Fi and Security
------------------------------	----------------------------------	----------------	------------------	---------------------------------------

### Customer Space Cabling Infrastructure

MDA Fiber	EDA Fiber	EDA Copper	FiberGuide Raceway
-----------	-----------	------------	--------------------

### Reference Designs and Technical Information

MDA Cabinet	MDA Cross-connect 19-in.	MDA Cross-connect FACT ODF	IDF FACT	IDF 19-in.	FEC
-------------	--------------------------	----------------------------	----------	------------	-----



CommScope pushes the boundaries of communications technology with game-changing ideas and ground-breaking discoveries that spark profound human achievement. We collaborate with our customers and partners to design, create and build the world's most advanced networks. It is our passion and commitment to identify the next opportunity and realize a better tomorrow. Discover more at [commscope.com](https://commscope.com).

COMMSCOPE®

---

[commscope.com](https://commscope.com)

Visit our website or contact your local CommScope representative for more information.

© 2024 CommScope, LLC All rights reserved.

CommScope and the CommScope logo are registered trademarks of CommScope and/or its affiliates in the U.S. and other countries. For additional trademark information see <https://www.commscope.com/trademarks>. All product names, trademarks and registered trademarks are property of their respective owners.

CO-116946.2-EN (11/24)

