

HST-B4AFB1750NU000



HST, NOVUX™ Prodigy™ Hardened Standard Terminal, 4-port, Planar 1:
2 Splitter + two P2P, Flat toneable loose tube cable, 1750 ft/533 m,
Universal mounting bracket

- NOVUX™ Prodigy™ Hardened Multi-port Terminals incorporate Hardened connector technology that is designed to withstand the rugged outside plant environment
- Hardened connectors are factory-integrated and environmentally sealed for use in optical drop cable deployments
- Plug and play adapter ports ensure rapid cable installment in the outside plant access section of the network
- NOVUX™ Prodigy™ HST terminals are available with 2 to 12 ports and can be utilized in Single Fiber Point-to-Point (P2P) solutions
- Available with flat dielectric, flat toneable/locatable dielectric, armored or 5mm round cable
- NOVUX™ Prodigy™ smaller terminal size for aesthetics and allowing installation in constrained spaces
- NOVUX™ Prodigy™ terminals are available in Black (RAL# 9005) or Gray (RAL# 7035)
- CommScope Product ID plate with QR code link to product documents and C-Track

Product Classification

Regional Availability	Asia EMEA Latin America North America
Product Type	Access terminal, with splitter/tap
Product Brand	NOVUX™
Product Series	HST
Minimum Order Quantity	1

General Specifications

Cable Type	Toneable - Flat - Loose Tube
Cable, quantity	1
Distribution Type	1 x 2 splitter + P2P ports (2)
Drop Port Type	Hardened Prodigy SC/APC
Drop Port, quantity	4
Enclosure Color	Black (RAL 9005)
Mounting	Handhole Pedestal Pole Strand
Port Type	Hardened Prodigy SC/APC
Port, quantity	4
Splitter, quantity	1

HST-B4AFB1750NU000

Stub Type

Stub tail

Dimensions

Height

80 mm | 3.15 in

Width

79 mm | 3.11 in

Length

161 mm | 6.339 in

Cable Length, stub

1750 ft (533 m)

Cable Outer Diameter

4.3 x 10.1 mm (0.17 x 0.40 in)

Dimension Drawing

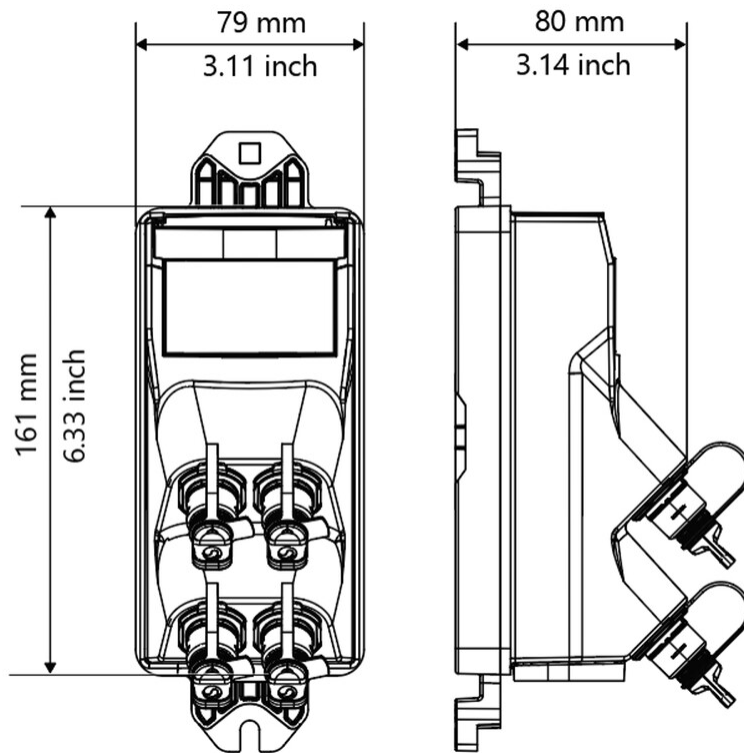

Port Configuration

NOVUX HT	TECHNOLOGIES AVAILABLE	SMALL	MEDIUM	LARGE	
HST Series	Single-fiber: P2P/no splitters	2 ports	6 ports	12 ports	
		4 ports	8 ports		
	Single-fiber: P2P w/splitters	2 ports, 1x1:2	8 ports, 2x1:4	12 ports, 3x1:4	
		4 ports, 1x1:4	8 ports, 1x1:8		
	Hybrid for multi-use			7 ports, 1x1:4 splitter, 3 P2P	12 ports, 1x1:8 splitter, 4 P2P
		4 ports, 1x1:2 splitter, 2 P2P	8 ports, 1x1:4 splitter, 4 P2P		11 ports, 2x1:4 splitter, 2 P2P, 1 HMFOC 4f

HST-B4AFB1750NU000

Ordering Tree

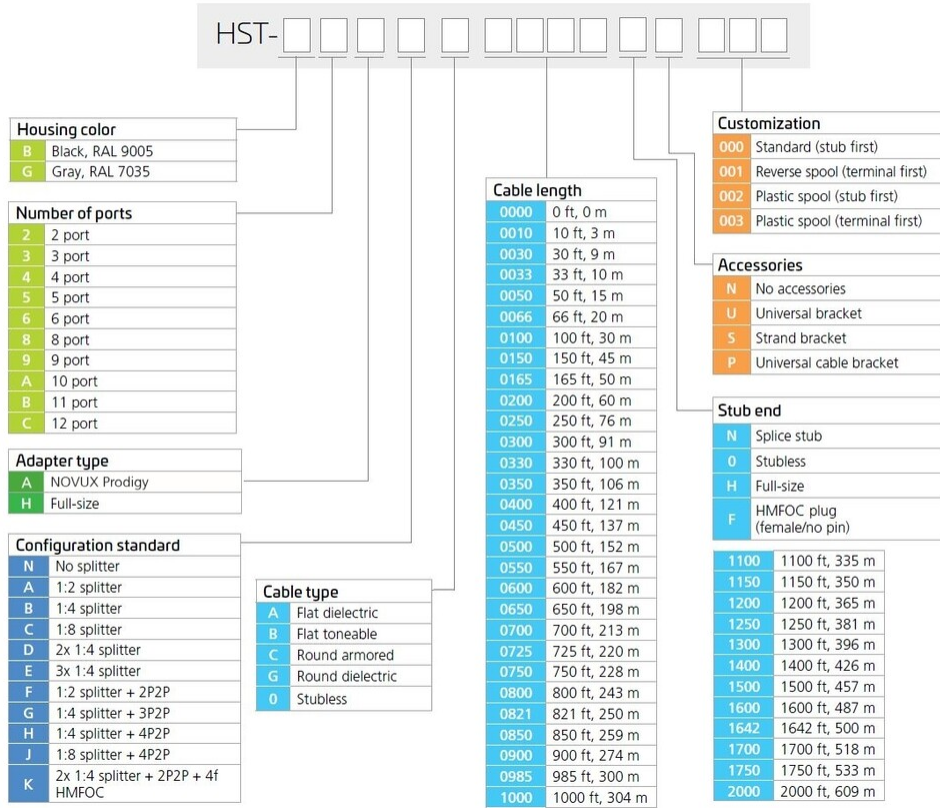

Material Specifications

Enclosure Material Type Hardened plastic

Optical Specifications

Fiber Type G.657.A1/A2

Operating Wavelength Range 1260 – 1635 nm

Attenuation Single Ports, maximum 4.1 dB

Attenuation Cable Coefficient, maximum 0.30 dB/km @ 1550 nm | 0.40 dB/km @ 1310 nm

Attenuation Splitter, maximum 3.7 dB

Attenuation Terminal Connectors, maximum 0.4 dB

Return Loss, Single Ports, minimum 55 dB

Environmental Specifications

Operating Temperature -40 °C to +65 °C (-40 °F to +149 °F)

HST-B4AFB1750NU000

Relative Humidity	5%–100%, condensing
Environmental Space	Above ground Below ground
Qualification Standards	IEC 61753-1, category G IEC 61753-111-08 (this represents an IEC 60529 IP68 intrusion protection level)
UV Resistance	UV stabilized

Packaging and Weights

Included	Universal mounting bracket
Packaging quantity	1
Packaging Type	Box Universal spool, cardboard: terminal is on top of the spool, stub deploys first

Regulatory Compliance/Certifications

Agency	Classification
CHINA-ROHS	Below maximum concentration value
ISO 9001:2015	Designed, manufactured and/or distributed under this quality management system
REACH-SVHC	Compliant as per SVHC revision on www.commscope.com/ProductCompliance
ROHS	Compliant
UK-ROHS	Compliant

