

HST-B4ANA1600NU000



HST, NOVUX™ Prodigy™ Hardened Standard Terminal, 4-port, Dielectric flat loose tube cable, 1600 ft/487 m, Universal mounting bracket

- NOVUX™ Prodigy™ Hardened Multi-port Terminals incorporate Hardened connector technology that is designed to withstand the rugged outside plant environment
- Hardened connectors are factory-integrated and environmentally sealed for use in optical drop cable deployments
- Plug and play adapter ports ensure rapid cable installment in the outside plant access section of the network
- NOVUX™ Prodigy™ HST terminals are available with 2 to 12 ports and can be utilized in Single Fiber Point-to-Point (P2P) solutions
- Available with flat dielectric, flat toneable/locatable dielectric, armored or 5mm round cable
- NOVUX™ Prodigy™ smaller terminal size for aesthetics and allowing installation in constrained spaces
- NOVUX™ Prodigy™ terminals are available in Black (RAL# 9005) or Gray (RAL# 7035)
- CommScope Product ID plate with QR code link to product documents and C-Track

Product Classification

Regional Availability	Asia EMEA Latin America North America
Product Type	Access terminal, without splitter/tap
Product Brand	NOVUX™
Product Series	HST
Minimum Order Quantity	1

General Specifications

Cable Type	Dielectric - Flat - Loose Tube
Cable, quantity	1
Distribution Type	4 ports
Drop Port Type	Hardened Prodigy SC/APC
Drop Port, quantity	4
Enclosure Color	Black (RAL 9005)
Mounting	Handhole Pedestal Pole Strand
Port Type	Hardened Prodigy SC/APC
Port, quantity	4
Stub Type	Stub tail

HST-B4ANA1600NU000

Dimensions

Height	80 mm 3.15 in
Width	79 mm 3.11 in
Length	161 mm 6.339 in
Cable Length, stub	1600 ft (487 m)
Cable Outer Diameter	4.3 x 8.0 mm (0.17 x 0.31 in)

Dimension Drawing

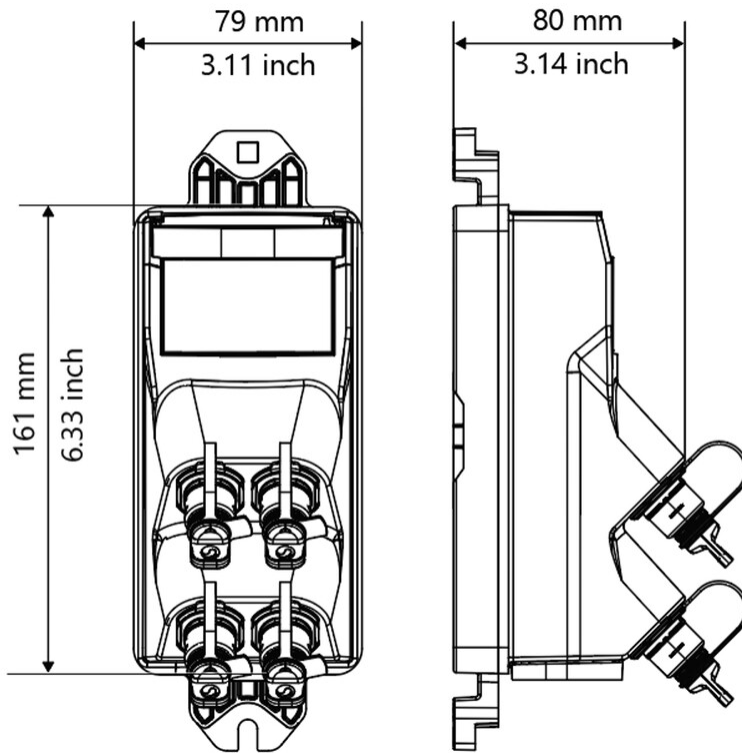

Port Configuration

NOVUX HT	TECHNOLOGIES AVAILABLE	SMALL	MEDIUM	LARGE
HST Series	Single-fiber: P2P/no splitters	2 ports	6 ports	12 ports
		4 ports	8 ports	
	Single-fiber: P2P w/splitters	2 ports, 1x1:2	8 ports, 2x1:4	12 ports, 3x1:4
		4 ports, 1x1:4	8 ports, 1x1:8	
	Hybrid for multi-use		7 ports, 1x1:4 splitter, 3 P2P	12 ports, 1x1:8 splitter, 4 P2P
		4 ports, 1x1:2 splitter, 2 P2P	8 ports, 1x1:4 splitter, 4 P2P	11 ports, 2x1:4 splitter, 2 P2P, 1 HMFOC 4f

Ordering Tree

HST-B4ANA1600NU000

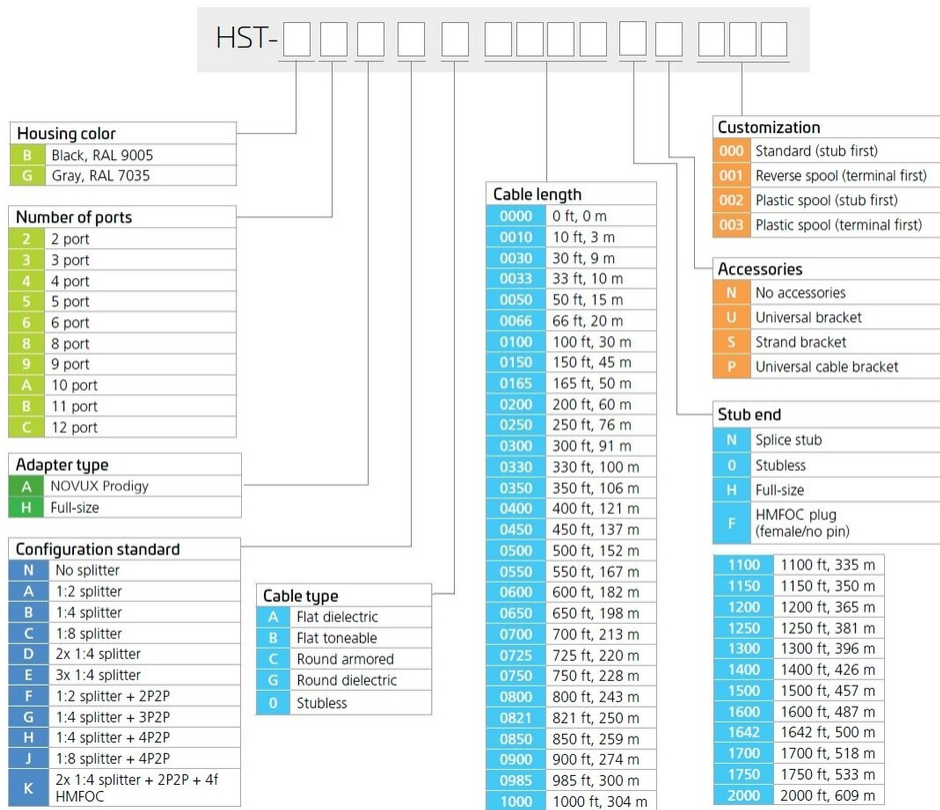

Material Specifications

Enclosure Material Type Hardened plastic

Optical Specifications

Fiber Type G.657.A1/A2

Operating Wavelength Range 1260 – 1635 nm

Attenuation Single Ports, maximum 0.4 dB

Attenuation Cable Coefficient, maximum 0.30 dB/km @ 1550 nm | 0.40 dB/km @ 1310 nm

Return Loss, Connector, typical 65 dB

Environmental Specifications

Operating Temperature -40 °C to +65 °C (-40 °F to +149 °F)

Relative Humidity 5%–100%, condensing

Environmental Space Above ground | Below ground

Qualification Standards IEC 61753-1, category G | IEC 61753-111-08 (this represents an IEC 60529 IP68)

HST-B4ANA1600NU000

UV Resistance

intrusion protection level)

UV stabilized

Packaging and Weights

Included

Universal mounting bracket

Packaging quantity

1

Packaging Type

Box | Universal spool, cardboard: terminal is on top of the spool, stub deploys first

Regulatory Compliance/Certifications

Agency

Classification

CHINA-ROHS

Below maximum concentration value

ISO 9001:2015

Designed, manufactured and/or distributed under this quality management system

REACH-SVHC

Compliant as per SVHC revision on www.commscope.com/ProductCompliance

ROHS

Compliant

UK-ROHS

Compliant

