

## **Glide Cable Management Cross-Connect and Interconnect Guide**

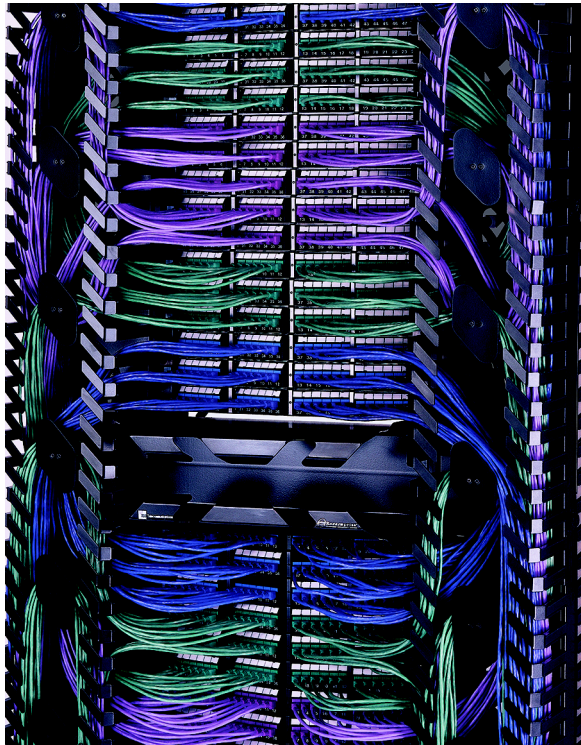

Content	Page(s)
<b>1. Maximum Required Patchcord Lengths</b>	
• One Rack with Two Glide Integrators, 9 Ft. Max. . . . .	3
• Two Racks with Adjacent Glide Integrators, 15 Ft. Max. . . . .	3
<b>2. General Cross-Connecting Procedures . . . . .</b>	<b>4–6</b>
<b>3. Multibay Cross-Connecting Procedures</b>	
• Connecting Ports on the Same Side of the Same Bay . . . . .	7
• Connecting Ports on the Outside Edge of Adjacent Bays . . . . .	8
• Connecting Ports on the Inside Edge of Adjacent Bays . . . . .	9
<b>4. Single Bay Cross-Connecting Procedures</b>	
• Connecting Ports on the Same Side of a Single Bay . . . . .	10
• Connecting Ports on the Opposite Side of a Single Bay . . . . .	11
<b>5. Interconnection Procedures</b>	
• Overhead and Raised Floor Cabling . . . . .	12

## 1. Maximum Required Patchcord Lengths

- One Rack with Two Glide Integrators, 9 Ft. Max.
- Two Racks with Adjacent Glide Integrators, 15 Ft. Max.



### Where to Get CommScope Assistance

Website

<http://www.commscope.com>

Product Patents

<http://www.commscope.com/ProductPatent/ProductPatent.aspx>

Product Support

<http://www.commscope.com/SupportCenter>

### Trademark Information

CommScope (logo) and CommScope are registered trademarks of CommScope, Inc.

### Disclaimer of Liability

Contents herein are current as of the date of publication. CommScope reserves the right to change the contents without prior notice. **In no event shall CommScope be liable for any damages resulting from loss of data, loss of use, or loss of profits and CommScope further disclaims any and all liability for indirect, incidental, special, consequential or other similar damages. This disclaimer of liability applies to all products, publications and services during and after the warranty period.**

This publication may be verified at any time by contacting CommScope Technical Assistance Center (see **Product Support**, above).

## 2. General Cross-Connecting Procedures

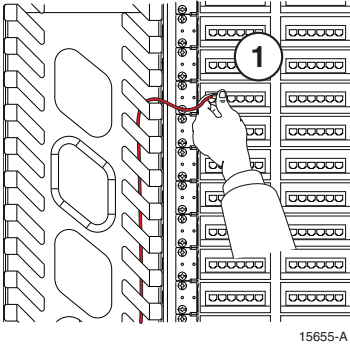

- 1 **TERMINATE** one end of the patchcord at the appropriate port.

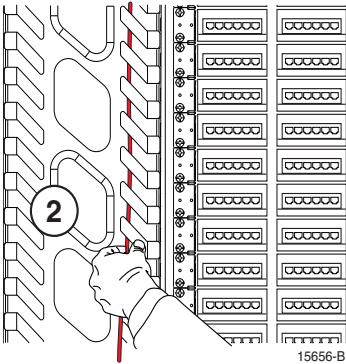

- 2 **ROUTE** the patchcord through the vertical cable guides to the upper or lower trough.

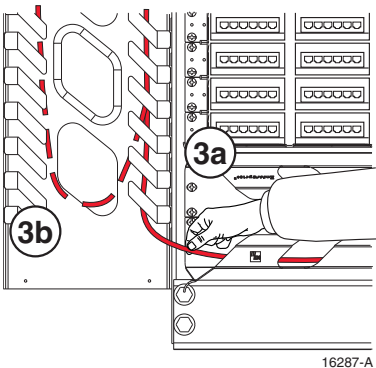

- 3a **PLACE** the patchcord in the upper or lower trough.

OR

- 3b **LOOP** the patchcord around the integrator spools.

## 2. General Cross-Connecting Procedures, continued

- ④ **ROUTE** the unterminated end of the patchcord to the second connection port.

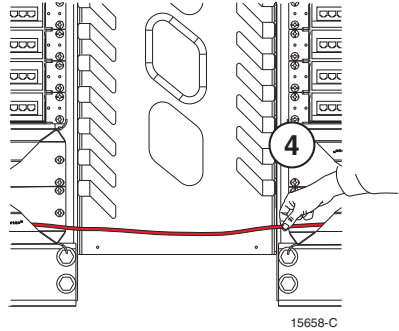

- ⑤ **TERMINATE** the second end of the patchcord to the appropriate port.

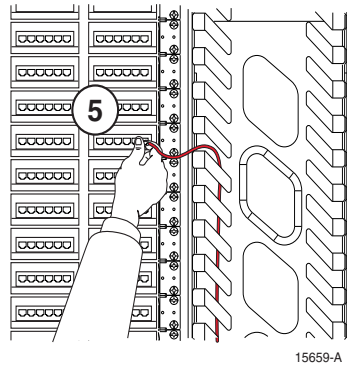

- ⑥ **ROUTE** the second end of the patchcord through the vertical cable guides to the upper or lower trough.

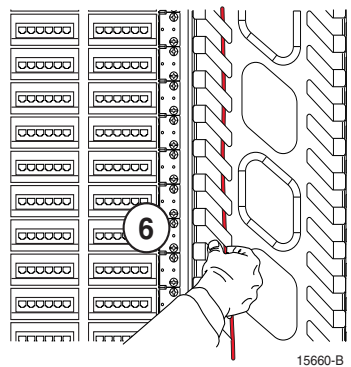

## 2. General Cross-Connecting Procedures, continued

- 7 LOOP the patchcord slack, located in the upper or lower trough, over the appropriate integrator spool.

➡ **NOTE:** See appropriate application drawing located within this user manual for recommended specific cable routings.

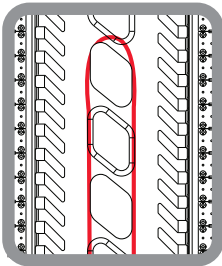
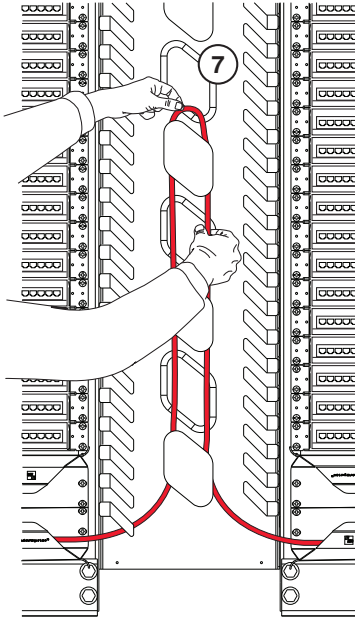

**CORRECT ROUTING**

DO NOT WRAP PATCH CORD MULTIPLE TIMES AROUND SAME SPOOL

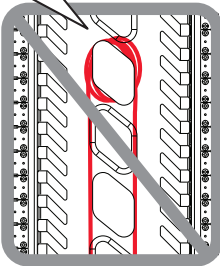

DO NOT WEAVE PATCH CORD AROUND SPOOLS

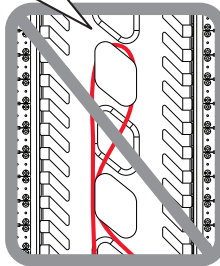

**INCORRECT ROUTING**

15661-B

### 3. Multibay Cross-Connecting Procedure

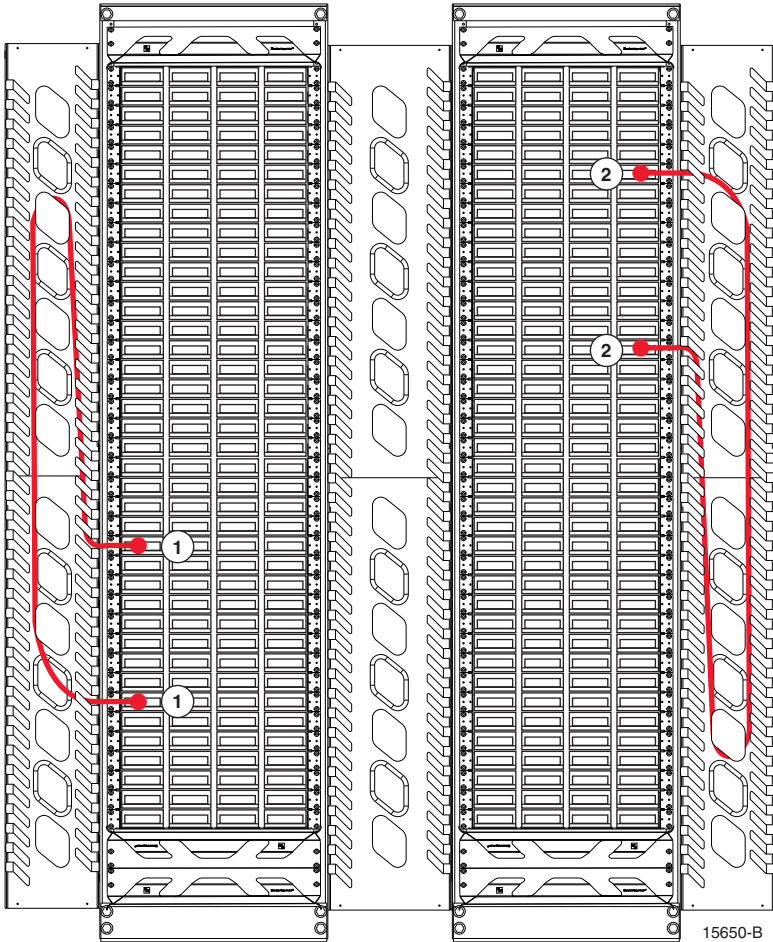

**Connecting Ports on the Same Side of the Bay**

### 3. Multibay Cross-Connecting Procedures, continued

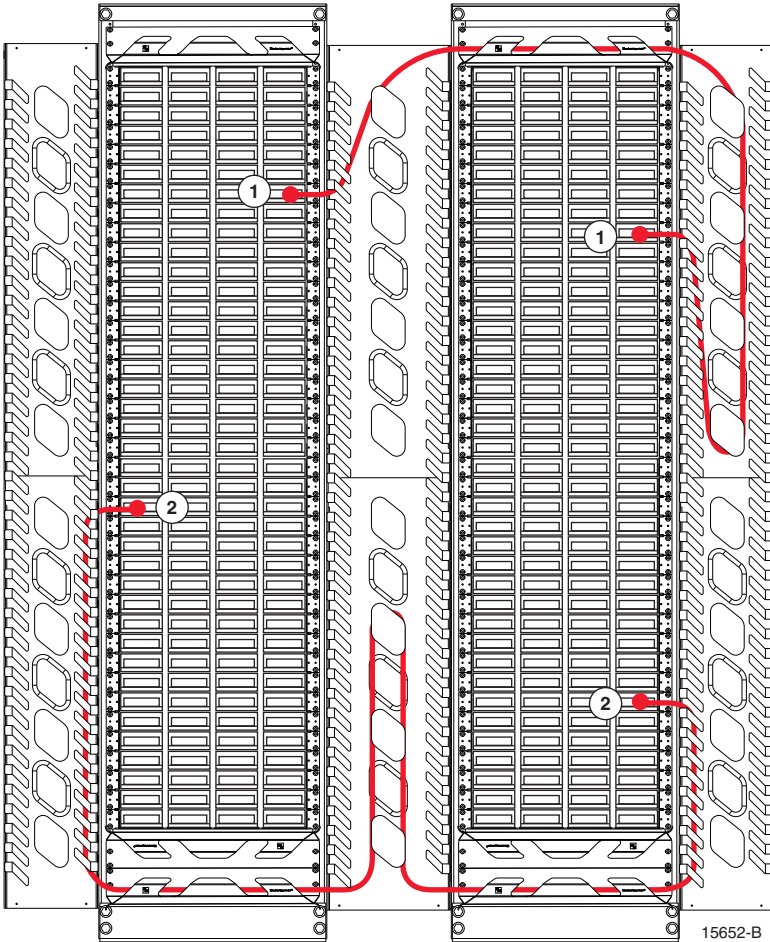

**Connecting Ports on the Outside Edge of Adjacent Bays**



### 3. Multibay Cross-Connecting Procedures, continued

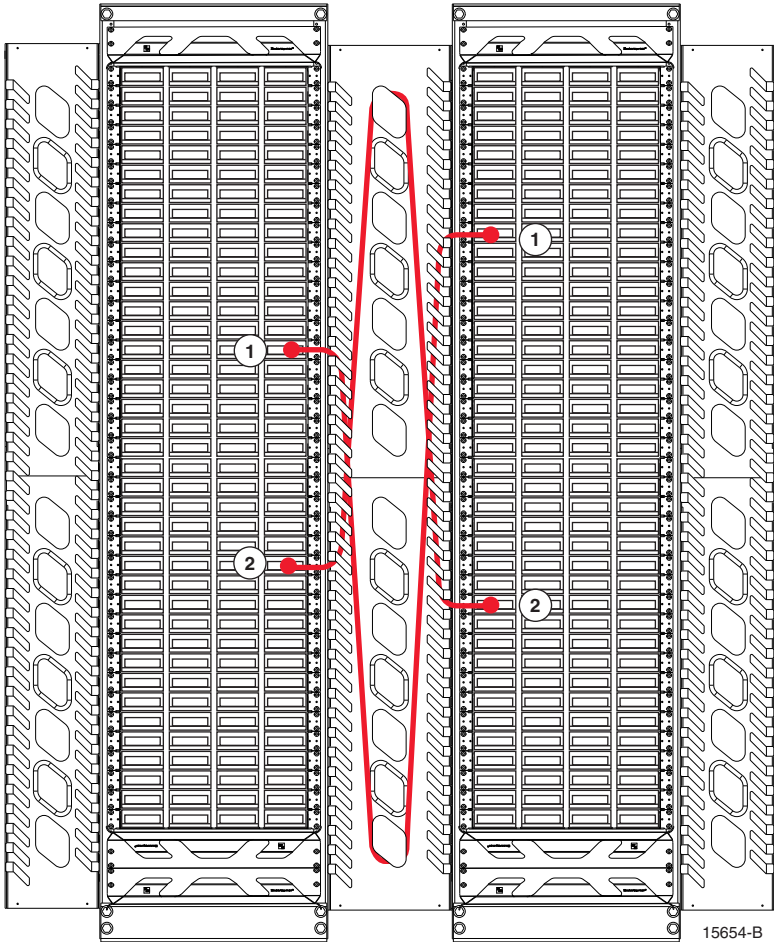

**Connecting Ports on the Inside Edge of Adjacent Bays**

## 4. Single Bay Cross-Connecting Procedures

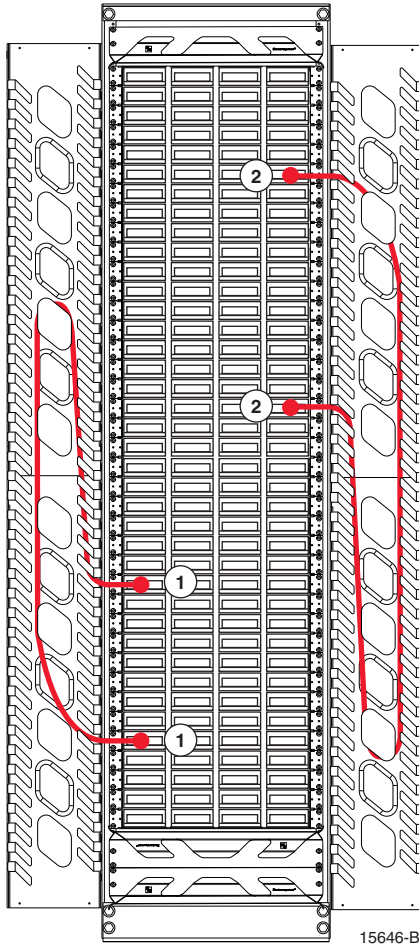

### Connecting Ports on the Same Side of a Single Bay

## 4. Single Bay Cross-Connecting Procedures, continued

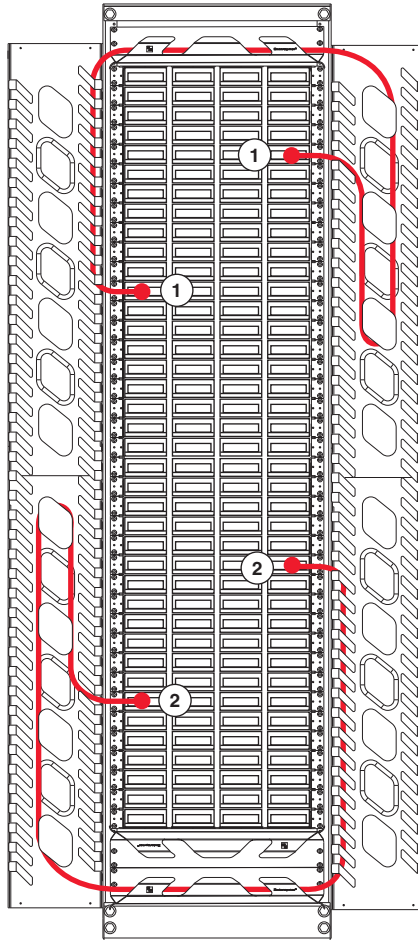

15647-B

### Connecting Ports on Opposite Sides of a Single Bay

## 5. Interconnection Procedures

