

PM-SU4-63



Universal Sliding Pipe Mount Kit for 4-1/2 in OD x 63 in pipe

Product Classification

Product Type Pipe mount

General Specifications

Mounting Angle 60°, 203.2 mm (8 in) | Angle 90°, 152.4 mm (6 in) | Straight or tapered legs up to 203.2 mm (8 in) OD

Note One 96 in x 8 in panel antenna per sector

Pipe, quantity 1

Tower Taper Tapered

Dimensions

Height 1,600.2 mm | 63 in

Width 304.8 mm | 12 in

Length 304.8 mm | 12 in

Pipe Length 1,600.2 mm | 63 in

Mounting Diameter, maximum 203.2 mm | 8 in

Mounting Diameter, minimum 0 mm | 0 in

Pipe Outer Diameter 114.3 mm | 4.5 in

PM-SU4-63

Outline Drawing

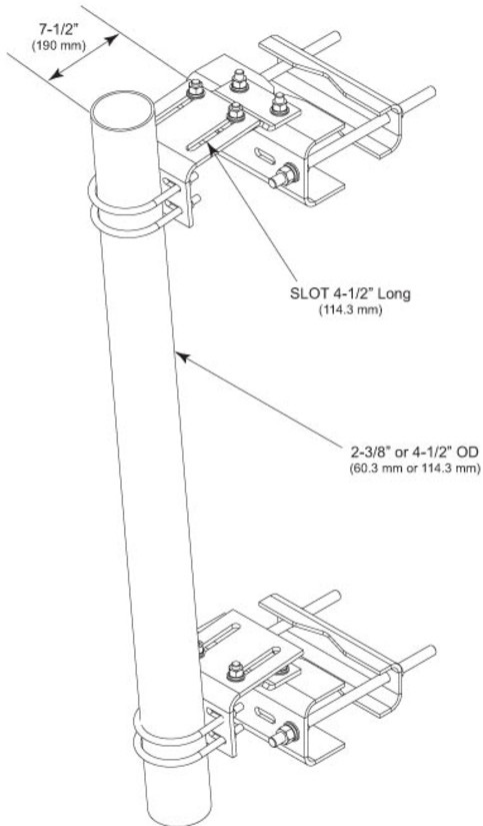

Material Specifications

Material Type Hot dip galvanized steel

Mechanical Specifications

Wind Rating 120 mph (BWS) at 150 ft AGL

Wind Rating Test Method TIA/EIA-222

Packaging and Weights

Included Pipe | Sliding pipe mount brackets | Universal saddle mount

Packaging quantity 1

PM-SU4-63

Weight, net 62.6 kg | 138.009 lb

Regulatory Compliance/Certifications

Agency	Classification
ISO 9001:2015	Designed, manufactured and/or distributed under this quality management system

Included Products

MT-653-63	- Plain End Pipe, 4-1/2 in OD x 63 in x .237" A500C 46Ksi
PM-SL4	- Universal Taper Pipe Mount Slider Bracket for 4-1/2 in OD pipe
SM-U2080	- Universal Saddle Mount for straight or tapered legs up to 8 in OD, 8 in angle 60°, or 6 in angle 90° (Kit of 2)

* Footnotes

Wind Rating BWS—Base Wind Speed; FBC—Florida Building Code