

WT-SPM12-12-126

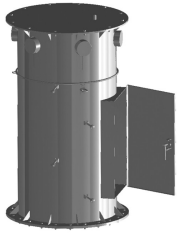

Stackable Pod Mount Assembly, 3-sector platform, 12 ft face, twelve 2-3/8 in OD x 126 in plain end pipes included

Product Classification

Product Type Water tower mount

General Specifications

Mounting Hatch plate

Pipe, quantity 12

Sectors, quantity 3

Dimensions

Height 3,200.4 mm | 126 in

Face Width 3.81 m | 12.5 ft

Width 3810 mm | 150 in

Length 3810 mm | 150 in

Pipe Length 3,200.4 mm | 126 in

Compatible Diameter 1,219.2 mm | 48 in

Pipe Outer Diameter 60.96 mm | 2.4 in

WT-SPM12-12-126

Outline Drawing

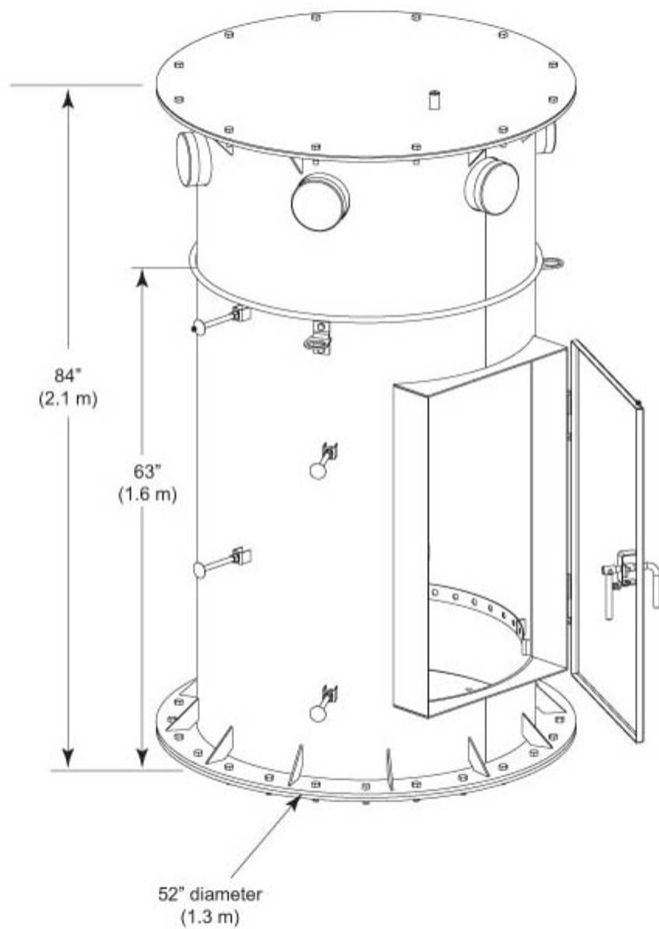

Material Specifications

Material Type Hot dip galvanized steel

Packaging and Weights

Included Mount | Plain end pipes (12) | Platform

Packaging quantity 1

Weight, net 1,450.18 kg | 3,197.1 lb

Regulatory Compliance/Certifications

Agency **Classification**

WT-SPM12-12-126

ISO 9001:2015

Designed, manufactured and/or distributed under this quality management system

Included Products

- | | | |
|-------------|---|--|
| MC-RM3060-3 | - | Universal Ring Mount, 30 in to 60 in OD |
| MT-196 | - | Low Profile Co-location Base Platform, 12 ft face. Ring Mount & Antenna Pipes Sold Separately. |
| MT-220-120 | - | Pipe Mount Kit, 2-3/8 in OD x 126 in |
| WT-SPM-B | - | Stackable Pod Mount Assembly, platform and plain end pipe not included |