



Broadband Applications & Construction Manual

Trunk & Distribution Cable Products

COMMSCOPE®

Table of Contents

Advanced Coring Technology®	4
Advanced Coring Technology®	5
Inspecting and Unloading CommScope Cables.....	7
Unloading CommScope Cable	8
Storage and Stacking CommScope Reels.....	9
Testing CommScope Cables	10
Impedance/TDR (Time Domain Reflectometer) Testing	11
Aerial Installation of CommScope Cable.....	12
Pulling Tension	13
Bending Radii.....	14
Expansion Loops	15
Expansion Loops - Forming	16
Expansion Loops - Various Configurations	17
Installation - Back-Pull/Stationery Reel Set-Up.....	18
Back-Pull/Stationery Reel - Puller Set-Up and Block Placement	19
Back-Pull/Stationery Reel - Passing the Pole and Winching.....	20
Back-Pull/Stationery Reel - Making Expansion Loops and Lashing	21
Back-Pull/Stationery Reel - Passing the Lasher at the Pole	22
Drive-Off/Moving Reel Set-Up and Lashing.....	23
Drive-Off/Moving Reel - Expansion Loops/Passing the Pole	24
Installation - Overlashing Existing Cable	25
Overlash Cable Placement.....	25
Integrated Messenger Installation.....	26
Down Guys.....	27
Hardware and Block Placement.....	28
Moving Reel Method	29
Stationary Reel Method.....	30
Tensioning	32
Dead Ending.....	33
Cable and Strand Separation.....	34
Pole Attachment.....	35

- Splicing.....36
- Underground Installation of CommScope Cable.....38
- Pulling Tension.....39
- Bending Radii.....40
- Underground Installation - Vibratory Plowing.....41
- Underground Installation - Vibratory Plow Movement.....42
- Trenching.....43
- Boring and Conduit Installations.....44
- Installing CommScope Cable into Conduit.....45
- Coaxial Bonding - Optimizing Preparation and Connectorization.....46
- Cable Preparation with ACT®.....49
- What Makes ACT So Different?.....50
- Getting a Clean Core.....51
- P3® Connectorization.....52
- QR® Connectorization.....53
- Plant Maintenance.....55
- Construction Safety Issues.....56
- Occupational Safety and Health Administration (OSHA) Standards.....57
- National Electric Code (NEC) standards.....57
- NEC Articles 820.....58
- National Electric Safety Code (NESC) Standards and Construction Grades.....59
- NESC Table 232-1/Vertical Clearance of Wires.....60
- Pole Lease Agreements and other Codes and Regulations.....61
- Equipment/Benders and Dynamometers.....62
- Equipment/Blocks.....63
- Equipment/Blocks, Chutes and Brackets.....64
- Equipment/Lashers, Pullers, Positioners and Guides.....65
- Equipment/Lifting Tools and Brakes.....66
- Broadband Resource Center... your one stop source for cable information.....67
- Technical Services & Tools.....68
- Legal Disclaimer.....69

NOTE: Information in this manual is subject to change. Check the literature download area on on CommScope’s website for the most recent updates.

Advanced Coring Technology®

Another CommScope Innovation... Setting a New Standard in Cable Technology!

- Enhanced Mechanical Performance
- Meets/Exceeds ANSI/SCTE, EN50117, IEC and Cenelec
- Fully Backward Compatible
- Identical in Electrical Performance
- Patent Pending



Traditional coaxial trunk and distribution cables require considerable attention to the preparation of the cable end for proper connectorization. Critical to that end preparation is the proper removal of dielectric and bonding compound from the conductors.

The normal process for this requires the craftsman to first core the cable and then clean the center conductor in a second step. CommScope's new P3® with ACT® and QR® with ACT® cables virtually eliminate the center conductor cleaning step by enabling a clean coring process in which the center conductor is cleaned of dielectric and bonding compound during the coring process.

These cables meet and exceed all ANSI/SCTE, EN50117, IEC and Cenelec testing methods for trunk, feeder, and distribution cables.

Below is an example of a traditional P3® Cable:



residual dielectric and bonding compound on conductor after coring

Below is an example of P3® with ACT®:



conductor clean of dielectric and bonding compounds after coring

Advanced Coring Technology®

P3® with ACT® and QR® with ACT® cables were developed to address a question that has been clearly stated and often repeated by the craftsmen, engineers, and technical operations managers of the broadband industry.

Why must a hardline cable be so difficult and problematic to properly core and prep?

Before the introduction of ACT cables, craftsmen struggled with the cleaning of the center conductor. To remove the remaining dielectric and bonding compound craftsmen have:

- Used a metallic blade, resulting in loss of copper and negatively impacting the skin effect.
- Used a torch to heat up and soften the material, resulting in dielectric melt down inside the cable.

This dielectric melt down causes changes in the electrical and mechanical performance characteristics of the cable.

- Used chemical and petroleum based solvents to remove the material, exposing them to a toxic hazard unnecessarily and leaving inappropriate residues on the center conductor.
- Used a center conductor cleaning tool that requires blades to be replaced as they become worn or damaged.
- Used nothing, leaving the dielectric and bonding compound residue and causing poor signal performance and electrical anomalies.

ACT cables not only eliminate all of these issues, but also significantly reduce the time needed to core and prep the cable end and make connectorization easier. This is accomplished through the development of an advanced technology bonding agent coupled with CommScope's consistent manufacturing capabilities. This patent pending formulation leverages the shearing action produced by every coring tool enabling most tools to produce a one pass coring operation leaving the conductors clean of dielectric and bonding compounds. Tools and craft skill may affect the clean coring capabilities.

P3 with ACT and QR with ACT cables are expected to provide system operators with a reduction in truck rolls and labor cost for trunk and distribution plant. This reduction of truck rolls and labor cost is achieved through consistent clean coring. Ensuring that this critical step in the connectorization process is done right the first time every time eliminating many of the issues associated with poor connectorization, thus reducing the need to return to troubled locations to make corrective changes.



P3 and Service - the two names most often associated with CommScope

THE P3 JACKET is a tough medium-density polyethylene compound designed to resist the effects of sun, moisture and temperature extremes. CableGuard®, a unique crush resistant jacket, is also available.

STEEL ARMOR is available for added protection.



THE QR CENTER CONDUCTOR is copper-clad aluminum for superior RF transmission and is generally larger than the conductors found in competitive cable of similar outer diameter.

THE QR DIELECTRIC is a closed-cell polyethylene that is compressed during the swaging process. Compression allows the dielectric to actively press against the shield and help heal small dents. The closed-cell nature of the dielectric permits an impressively high velocity of propagation of 88%.

THE QR SHIELD is formed through a unique, high efficiency process where a precision tape is continuously roll-formed around the core and is then welded by RF induction. This results in a contaminant-free seam which is stronger than the surrounding material. We verify seam integrity with a core and cone test, where a cored sample is flared to a diameter well beyond even the most extreme installed usage.

MIGRA-HEAL®, CommScope's special underjacket compound, helps fill in jacket damage before moisture can seep in and cause corrosion.

THE QR JACKET is a tough medium-density polyethylene compound designed to resist the effects of sun, moisture and temperature extremes.

Double jacketing, in which two independent jackets are separated by polypropylene tape, is also available.

STEEL ARMOR is available for added protection.

Thin shield, compressed dielectric and a larger center conductor combine to make QR the best performing coax available anywhere

Inspecting and Unloading CommScope Cables

Trouble-free unloading begins with letting your CommScope Customer Service Representative know of any special packaging or delivery requirements (no shipping dock available, call before delivery, etc.). CommScope will make every reasonable effort to comply with your shipping needs.

When the shipment arrives, inspect every reel and pallet of material for damage as it is unloaded. Suspect cable should be set aside for a more detailed inspection before the shipping documents are signed.

Damage can occur during the unloading process. Coaxial cable can be damaged by dropping the reels or pallets, or improper handling of reels with a forklift.

Stacked cable must be carefully unstacked to prevent cable damage and possible injury. CommScope drivers are experienced in handling and unstacking the cable without injury or damage. A Cargomaster crane is useful in unstacking and unloading cable with or without a dock.

Common carriers are only required to move the cable to the back of the truck for unloading. If a common carrier driver cannot unstack the cable, the driver should be instructed to return to the shipping terminal where equipment exists to unstack the cable. The cable can be reloaded onto the truck on rolling edge.

If any cable damage is visible or suspected and if it is decided to accept the shipment, note the damage and the reel number on ALL copies of the bill of lading.

If the damage is too extensive to accept the shipment, advise the carrier's driver that the shipment is being refused because of the damage. Immediately notify CommScope's Customer Service Department so that arrangements can be made for a replacement shipment.

CommScope makes every effort to assure that QR and P3 cables arrive in the same 100% ready-to-install condition as when they left the factory.

Unloading CommScope Cable

UNLOADING AT A DOCK

Use a pallet jack or forklift to remove all cable on pallets. Remove any blocking materials for the individual rows of cable and roll the reels onto the dock. If the back of the trailer and dock are not at the same height, use an appropriate loading ramp to compensate for the difference.

UNLOADING WITHOUT A DOCK

If you use a ramp, it should be strong enough to support the weight of the unloading personnel and the heaviest cable reels. The ramp should have raised sides to prevent the cable reels from rolling off the sides of the ramp.

The ramp should be long enough to allow control of the momentum of the cable as it rolls down the ramp. A pulley system connected to the sides of the truck and to a shaft passing through the center of the reels can help control the momentum of the rolling reels. With this method, two workers can usually control movement of the heaviest reel.

If you use a Cargomaster crane, unstack and move the cable to the ground at the rear of the truck.

DO NOT drop reels off the back of the truck onto a stack of tires, onto the ground or any other surface.

The impact may injure personnel and damage the cable. Always use ample personnel to safely unload shipments of cable.

SHIPPING WEIGHTS	LBS/KFT (KG/KM)
QR 540 JCA, JCASS	120 (179)
QR 715 JCA, JCASS	205 (305)
QR 860 JCA, JCASS	291 (433)
P3 500 CA	97 (143)
P3 500 JCA	120 (179)
P3 500 JCASS	123 (183)
P3 625 CA	158 (235)
P3 625 JCA	182 (271)
P3 625 JCASS	185 (275)
P3 750 CA	237 (353)
P3 750 JCA	272 (405)
P3 750 JCASS	275 (409)
P3 875 CA	295 (439)
P3 875 JCA	336 (500)
P3 875 JCASS	342 (509)

Storage and Stacking CommScope Reels

CommScope cable can be stored indoors or outdoors, and the cable may be stacked on flange or stored upright on the rolling edge. Use a forklift or some type of overhead hoist to stack cable.

When cable is stored outside, the ground should be somewhat level and have good drainage to reduce the possibility of deterioration of the reel flanges. CommScope's reel recycling program only accepts reels in good condition.

Reels which are stored on the rolling edge should be aligned flange to flange to prevent possible damage to the cable once the protective cover has been removed.

STACKING COMMSCOPE CABLE

When CommScope cable is moved, shipped, or stored, use this table to ensure that maximum stacking heights are not exceeded. Consideration must be given to the maximum height as well as the total weight of the stack. To allow the use of a pallet jack or forklift, place boards between each layer and a pallet on the ground under the bottom reel. Exceeding the recommended storage and loading heights may damage the cable due to flange deflection.

QR CABLE	MAXIMUM STORAGE HEIGHT	MAXIMUM LOADING HEIGHT
QR 540	5 Reels	3 Reels
QR 715	5 Reels	3 Reels
QR 860	5 Reels	3 Reels
P3 CABLE	MAXIMUM STORAGE HEIGHT	MAXIMUM LOADING HEIGHT
P3 500	6 Reels	4 Reels
P3 625	6 Reels	4 Reels
P3 750	5 Reels	3 Reels
P3 875	5 Reels	3 Reels

Testing CommScope Cables

While testing reels of CommScope cables after delivery is not required, testing prior to, during and after construction will identify any degradation in the performance of the cable caused during installation.

There are three phases in CommScope cable testing:

1. Visual inspection for shipping damage
2. Pre-installation testing, which occurs immediately after delivery of the cable;
3. Post-installation/final acceptance testing, which occurs just prior to activation. Post-installation testing is accomplished as part of system activation and as proof of performance. Broadband frequency response (sweep) testing is included as a part of the activation process.

PRE-INSTALLATION TESTING

Pre-installation testing of CommScope cable typically consists of SRL and impedance/TDR (Time Domain Reflectometer) tests, with the TDR test being the quickest way to discover cable damage. These pre-installation checks can be jointly conducted by the system operator and the construction group in order to preclude future difficulties if a cable is damaged during construction.

Attenuation (insertion loss) tests are seldom conducted after shipment, but can be easily performed during pre-installation testing. Testing for attenuation by conventional methods is extremely difficult after installation due to the physical placement of the cable over substantial distances.

POST INSTALLATION - FINAL ACCEPTANCE TESTING

SRL and TDR tests can be performed after installation if required. The results should be compared to the pre-installation test.

Every reel of CommScope cable is extensively tested prior to shipment for attenuation, Structural Return Loss (SRL) and impedance with certified test reports available at your request

Impedance/TDR (Time Domain Reflectometer) Testing

Impedance testing using a TDR is a quick and straightforward method for finding the distance from the test point to any fault (shown as an impedance mismatch) in the cable.

Impedance tests should be made from both ends of the cable to ensure finding the correct distance to fault. The correct velocity of propagation (Vp) for the test is essential - an incorrect Vp will cause a proportional measurement error in the distance to the fault. The Vp for QR cable is 88%. The Vp for P3 cable is 87%.

Impedance tests should be done per the standards set forth in SCTE-TP-006. Impedance testing will require a time domain reflectometer (TDR). Methods of operation will vary for each TDR; however, these are general guidelines for using one:

1. Set the velocity of propagation for 88% for QR or 87% for P3, and the impedance reference for 75 ohms.
2. Adjust the display for a sharp, clear baseline, and position the leading edge to a convenient starting point or graticule.
3. Set the pulse width as recommended by the TDR manufacturer.
4. Attach the test lead (coaxial cable test leads are preferred) to the cable under test. Connectors should match the impedance of the tested cable.
5. Adjust the display and control settings to show the entire length of the cable. The control settings can be adjusted to allow precise measurement of the distance to any impedance mismatch. Operator proficiency and equipment capability are critical factors in making consistent and precise measurements.

End-to-end impedance tests are very beneficial in an evaluation of post-installation plant performance. The TDR traces should be kept with the as-built drawings along with the reel numbers of the installed cable.

Aerial Installation of CommScope Cable

There are two cable types built specifically for aerial installation:

QR/P3 JCA the standard construction, available in five sizes for trunk and feeder installation, to be lashed to a strand or support wire, and

QR/P3 JCAM standard construction with a messenger extruded in place in a figure-8 design.

The two preferred methods for installation are the back-pull/stationary reel method and the drive-off/moving reel method. Circumstances at the construction site and equipment/manpower availability will dictate which placement method will be used.

THE BACK-PULL/STATIONARY REEL METHOD

is the usual method of cable placement. The cable is run from the reel up to the strand, pulled by a block that only travels forward and is held aloft by cable blocks. Cable is then cut and expansion loops formed - lashing takes place after the cable is pulled.

THE DRIVE-OFF/MOVING REEL METHOD

may realize some manpower and time savings in cable placement and lash-up. In it, the cable is attached to the strand and payed-off a reel moving away from it. The cable is lashed as it is being pulled - cuts and expansion loops are made during lashing.

Regardless of the installation method, mechanical stress is of great concern during cable placement. Like other coaxial cables, QR can be damaged by exceeding the maximum allowable pulling tension or the minimum allowable bending radii. Fortunately, QR's highly flexible construction permits lower than normal pull tensions and tighter bends, almost completely eliminating the chance of cable installation

QR cables are particularly resistant to deformation in cable geometry during installation due to their highly flexible construction

Make sure all down guys at corners and dead ends are installed and tensioned prior to cable placement.

Pulling Tension

Pulling tension for CommScope cables are shown in this chart. JCAM cables should be pulled by the messenger, where the maximum pulling tension is limited by its minimum breaking strength. Cables are available with a .109 in (3mm) messenger rated at 1800 lbs (818 kgf), .188 in (5 mm) messenger rated at 3900 lbs (1769 kgf) or .250 in (6 mm) messenger rated at 6650 lbs (3022 kgf).

CABLE	MAX. PULLING TENSION LBS / KGF
QR 540	220 (100)
QR 715	340 (154)
QR 860	450 (204)
P3 500	300 (136)
P3 625	475 (216)
P3 750	675 (306)
P3 875	875 (397)

NEVER EXCEED THE MAXIMUM PULLING TENSION.

Excessive forces applied to the cable will cause the cable to permanently elongate. Good construction techniques and proper tension monitoring equipment are essential. The highly flexible nature of QR cable makes it very difficult to exceed the maximum pulling tension.

During cable placement, attention should be given to the number and placement of cable blocks. The amount of sag between the blocks and the amount of bending at the block affects the pulling tension.

Tail loading is the tension in the cable caused by the mass of the cable on the reel and reel brakes. Tail loading is controlled by two methods. It can be minimized by using minimal braking during the pay-off of the cable from the reel - at times, no braking is preferred. Tail loading can also be minimized by rotating the reel in the direction of pay-off.

Break-away swivels should be placed on each cable to ensure that the maximum allowable tension for that specific cable type is not exceeded. The swivel is placed between the cable puller and pulling grip. A break-away swivel is required for each cable.

Dynamometers are used to measure the dynamic tension in the cable. These devices allow continuous review of the tension and accordingly a realization can be made of any sudden increase in pulling tension. Sudden increases in pulling tension can be caused by many factors such as a cable falling from a block or a cable binding against pole-line hardware.

QR's flexible construction means less pulling effort is required

Bending Radii

Cables are often routed around corners during cable placement and pulling tension must be increased to apply adequate force to the cable to bend the cable around the corner. Tension is directly related to the flexibility of cable - and flexibility is QR's greatest strength.

QR cable's shield construction permits the tightest bend radius in the industry

CABLE	MINIMUM BENDING RADII IN/CM
QR 540	4 (10.2)
QR540 Armored	6.5 (16.5)
QR 715	5 (12.7)
QR 715 Armored	7.5 (19.1)
QR 860	7 (17.8)
QR 860 Armored	9.5 (24.1)
P3 500 standard (jacketed)	6.0 (15.2)
P3 500 bonded (jacketed)	3.5 (8.9)
P3 625 standard (jacketed)	7.0 (17.8)
P3 625 bonded (jacketed)	4.5 (11.4)
P3 750 standard (jacketed)	8.0 (20.3)
P3 750 bonded (jacketed)	6.0 (15.2)
P3 875 standard (jacketed)	9.0 (22.9)
P3 875 bonded (jacketed)	7.0 (17.8)

CommScope's specified minimum bending radius is the static (unloaded) bending radius of the cable. This is the minimum radius to which the cable can be bent without electrically or mechanically degrading the performance of the cable. Bending the cable in this manner is usually only done during splicing or final forming. This is also the radius allowed for storage purposes.

Always review the specifications for the appropriate bend radii. If you do not exceed the minimum bend radius nor exceed the maximum pulling tension, you should have a successful installation.

The bending radii of cables during the construction process are controlled by construction techniques and equipment. Corner blocks and set-up chutes have large radii and low friction surfaces that minimally contribute to the overall increase in pulling tension.

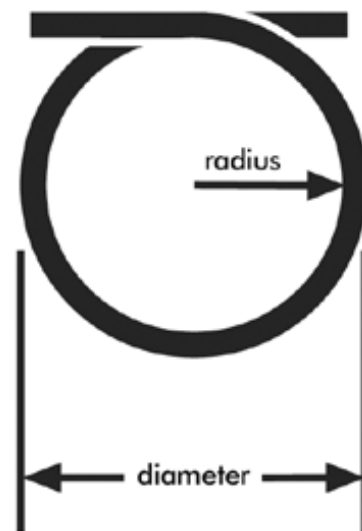

Expansion Loops

As temperature rises and falls, coaxial cable will expand/contract at almost twice the rate of strand. Expansion loops allow the cable to move to allow for stress caused by thermal changes and strand creep. They are critical to cable life. A typical loop will use no more than an extra 2 - 3 inches (5 - 8 cm) of cable. Loops are formed using mechanical benders or bender boards.

CommScope strongly recommends the use of mechanical benders for consistently-formed loops.

WHEN TO PLACE EXPANSION LOOPS

Loops are formed prior to lashing in the back-pull method and during lashing in the drive-off method. In either case, it is recommended that you keep the bender in place as the cable is being lashed. Remove the bender only after the cable has been lashed to the strand.

WHERE TO PLACE EXPANSION LOOPS

Form one expansion loop at each pole, on the input/output of every active device and at every tap. Form two loops at a pole where the span length exceeds 150 feet (45 meters), on street/RR crossings and in spans with little to no midspan sag.

If you are running multiple cables, do not bind them together in the same loop.

An expansion loop is supported on the strand by a strap fitted with a spacer that separates the cable from the strand. The strap should be no more than hand-tightened.

The cable must be permitted to move within the loop or the cable may buckle and fail.

Place the bug nut 4" from the end of the loop and place the spacer and strap on the span side of the loop behind the bug nut. (See diagram.)

Note: the end of the loop is at the end of the loop forming tool.

QR expansion loops will last 2 - 3 times longer than those of conventional coaxial cable



Expansion Loops - Forming

Two different sizes of expansion loops are currently used.

For sizes < 625, use a mechanical bender to form a 12-inch flat bottom loop.

This bender produces a minimum 6" (15 cm) deep loop with a 12" (30 cm) flat bottom.

For sizes > 700, use a mechanical bender to form a 15-inch flat bottom loop.

This bender produces a minimum 6" (15 cm) deep loop with a 15" (38 cm) flat bottom.

If you are installing smaller cables with the larger sizes, it is recommended that you use the larger loop on all cables.

FORMING THE LOOP

Attach the mechanical bender to the strand at the appropriate location. Place the cable in the bender and form the loop according to the manufacturer's directions. Carefully inspect the cable for any damage due to misalignment of the bender.

DO NOT REMOVE THE BENDER until after the cable has been lashed at least 50' (15 meters) or to the next pole, as tensions imposed during lashing may deform the loop. Once the cable is lashed and the lash wire tied off, you may remove the bender. Double lashing is recommended for two or more cables.

Attach straps and spacers. Do not overtighten the straps.

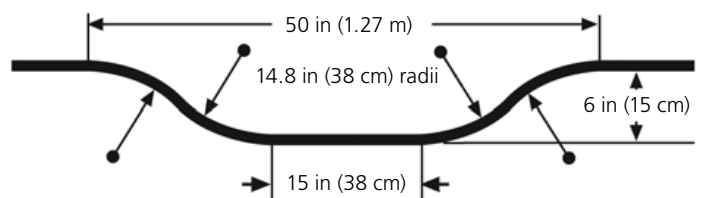
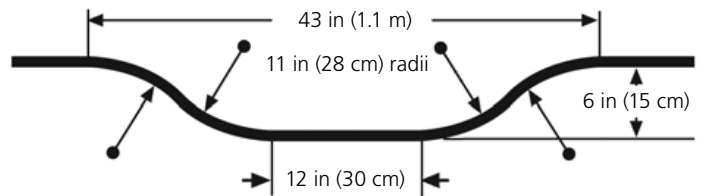

Expansion Loops - Various Configurations

These are several examples of common expansion loop configurations.

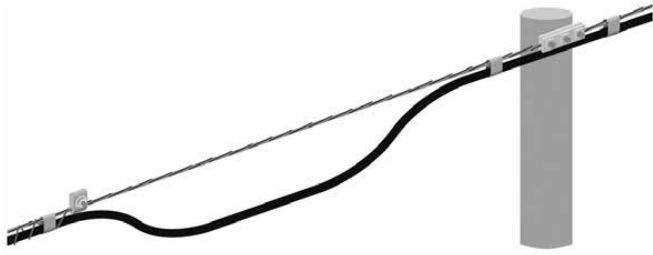

STRAIGHT POLE



ANGLED POLE



MID-SPAN CROSSOVER



DOUBLE DEAD-END



LINE POLE DEAD-END

Installation - Back-Pull/Stationery

Reel Set-Up

SET-UP CHUTE PLACEMENT

The set-up chute should be positioned on the first pole of the cable route or attached to the strand at the first pole. Placement of the set-up chute should keep the cable from rubbing on the reel or pole. Either a 45° or 90° corner block may be used as a set-up chute.

TRAILER SET-UP

The trailer should be positioned in-line with the strand and twice the distance of the set-up chute to the ground from the chute. This prevents the cable from rubbing on the pole or reel or binding on the chute. If the trailer cannot be positioned there, move the set-up chute and cable trailer to an adjacent pole.

The cable should pay-off the top of the cable reel. The pay-off of the cable from the reel should cause a downward force at the hitch of the trailer.

Chock the trailer wheels. Adjust the reel brakes as needed. Place protective barriers and cones as needed to protect pedestrians.

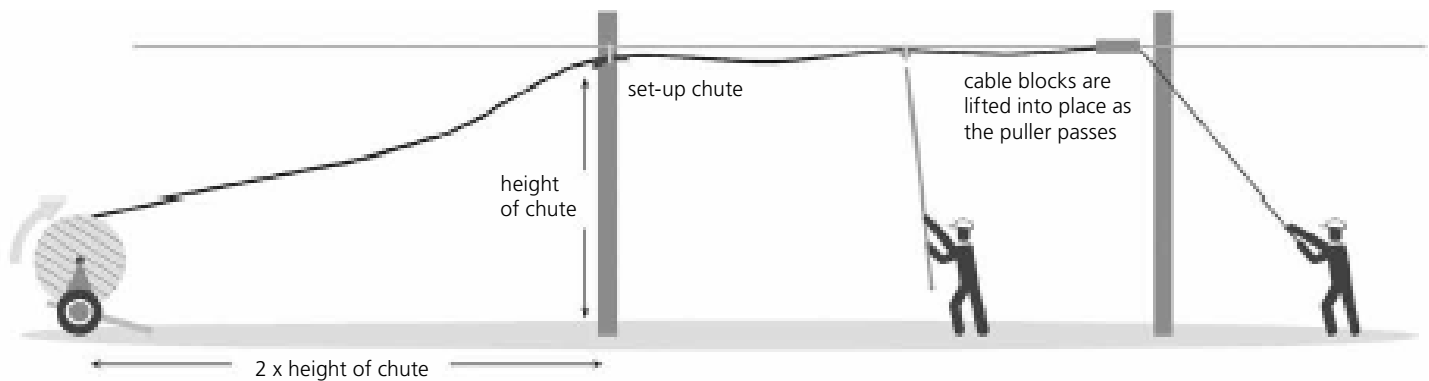

Back-Pull/Stationery Reel - Puller Set-Up and Block Placement

CABLE PULLER SET-UP

Place an appropriate cable grip on each cable. Secure the grip to the cable with tape to keep the cable from backing out of the grip should the pulling tension be relaxed.

Place a breakaway swivel between the pulling grip and the cable puller. An in-line dynamometer may be placed there instead or along with the breakaway swivel.

Place the cable puller on the strand and close the puller gates to secure the puller to the strand.

Attach a pulling line to the cable puller. Pull the cable puller along the strand by hand or by winch (see next page for winching notes). Place cable blocks to support the cable as it is pulled. The cable puller has an internal brake which prevents the cable puller from moving backward on the strand when the pulling tension is released.

DO NOT OVERSPIN THE REEL - KEEP THE CABLE WRAPS TIGHT.

CABLE BLOCK/CORNER BLOCK PLACEMENT

Use a cable block lifter/lay-up stick to place cable blocks on the strand every 30 - 50 feet (9 - 15 meters).

Place corner blocks at all corners greater than 30° in the pole line. NEVER pull cable over the end rollers of corner blocks as they will flatten and deform the cable.

At corners less than 30°, cable blocks can be placed on the strand several feet from and on each side of the pole/line hardware. The cable blocks should allow the cable to move through the corner without undue bending or drag.

Back-Pull/Stationery Reel - Passing the Pole and Winching

PASSING THE CABLE PULLER AT POLES

Pull the cable puller to the pole and release the tension in the pulling line. Pass the cable across the pole face and the pole/line hardware, and attach the cable puller back to the strand. Place cable blocks on each side of the pole.

At corner block locations, pass the cable puller to the opposite side of the pole and route the cables through the corner block.

CABLE TAILS

A cable tail at least 3 feet (1 meter) in length should be left at the first and last poles and at all splicing locations. More tail may be needed depending on the splicing that must be done or the size and location of the expansion loop that will be made. Cap the end of the cables and tie them gently but securely to the strand.

MAKE EVERY EFFORT TO AVOID DAMAGE AT THE CABLE TAILS.

POWER WINCHING METHODS

Power winching a pull line to install CommScope cable is a method often used when the poleline is obstructed or is in extremely rough terrain because the pull line can be placed without tension concerns. In winching, the pull line is placed in the cable puller and run along the strand. Once the pull line is run, it is attached to the cable.

Carefully tension the pull line and begin pulling. Adjust the reel brakes to prevent undue pulling tension. Real-time tension monitoring is required. Radio communication between the lineman observing the pull-out and the winch operator is required. Intermediate cable handling may be required as the pulling grips approach cable and corner blocks.

QR's longer length and superb flexibility lend itself to power winching and longer lengths are available

Back-Pull/Stationery Reel - Making Expansion Loops and Lashing

MAKE YOUR EXPANSION LOOP PRIOR TO LASHING

If an expansion loop is called for (see Aerial Installation/3.4), attach the mechanical bender to the strand and form the loop per the manufacturer's directions.

DO NOT REMOVE THE BENDER UNTIL AT LEAST 50 FT (15 METERS) OF THE CABLE HAS BEEN LASHED.

ATTACH THE LASHING WIRE CLAMP

Place the lasher on the strand. Wrap the lashing wire twice around the strand in the same direction as the twist in the strand and in the lay of the strand. Pass the lashing wire between the washers of the lashing wire clamp without overlapping the wire. Wrap the wire around the clamp to the post on the opposite side of the clamp and wrap it twice around the post. Cut the wire and tuck it between the halves of the lashing wire clamp. Use appropriate-sized spacers to prevent the cable from rubbing against the pole hardware. NOTE: it is essential that double lashing be used with two or more cables, all trunk cables and at street and RR crossings.

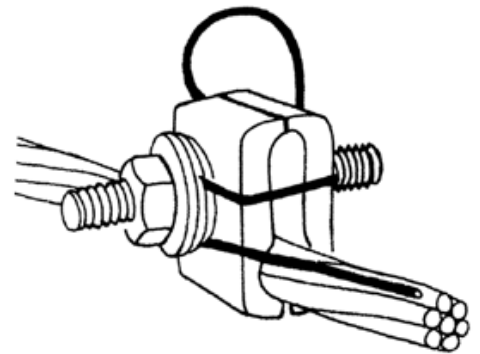

Place the cable within the lasher. A cable positioner may be arranged ahead of the lasher for extra guidance as the lasher is pulled toward the reel. Pull the lasher toward the reel with a wire or rope.

It is important to minimize the sag on cables as they enter the lasher. Leave the cable blocks in place until the lasher is close enough to support the cable. As the lasher approaches cable blocks, either remove them with a cable block lifter or push the cable blocks to the next pole by utilizing a cable block pusher.



Back-Pull/Stationery Reel - Passing the Lasher at the Pole

PASSING THE LASHER AT THE POLE

Pull the lasher toward the pole to be passed. Attach a lashing wire clamp to the strand. Remove the lasher from the strand and move it across the pole-face to the strand and cable on the opposite side of the pole.

Put the cable into the lasher. Close the gates to prevent the lasher from being pulled backward along the strand. Cut the lashing wire from the lasher and secure the lashing wire to the lashing wire clamp. Make sure that the lashing wire does not loosen from around the cable.

Attach appropriate straps and spacers as needed. At the back end of the lasher, attach a lashing wire clamp to the strand about to be lashed. Attach the lashing wire to the clamp. Continue lashing as before.

Carefully rotate the cable reel to take up any excess cable slack prior to lashing each section.

REMEMBER NOT TO LASH THE CABLE TOO TIGHTLY. COAXIAL CABLE MUST BE PERMITTED TO CONTRACT AND EXPAND ALONG THE STRAND OR THE CABLE MAY BUCKLE AND FAIL.



Drive-Off/Moving Reel Set-Up and Lashing

TRAILER SET-UP

Pay the cable off the top of the reel rotating toward the rear of the cable trailer. Use minimal reel braking.

ATTACHING THE LASHER, SET-UP CHUTE AND CABLE

Attach a lashing wire clamp to the strand (see Aerial Installation/3.11) far enough from the initial pole to accommodate a required expansion loop or equipment. Place the lasher on the strand and attach the lashing wire to the lashing wire clamp.

Position the set-up chute in front of the lasher and attach it to the lasher with a block pusher (or shotgun). Attach the pull line to the set-up chute or lasher.

Thread the cable through the set-up chute and place the cable in the lasher. Leave sufficient cable tail to accommodate a loop, splice or equipment. Close the lasher gates.

The cable should move only through the chute. If the pole-line is offset from the reel, observe the cable closely as it moves through the chute. Cable reel offset may cause the cable to drag on the reel flange and the cable in the chute to bind.

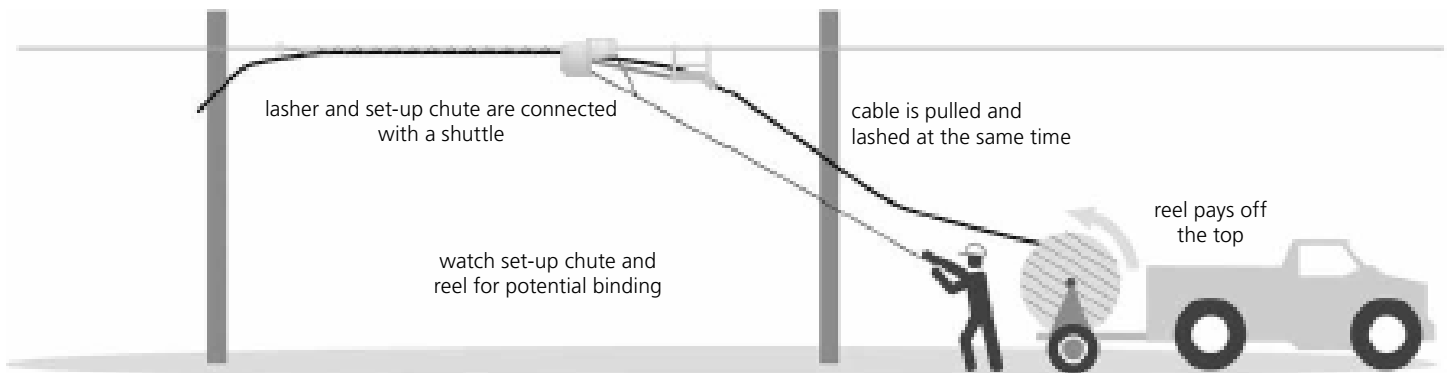

Drive-Off/Moving Reel - Expansion Loops/Passing the Pole

FORM THE EXPANSION LOOPS

Stop the lasher about 6 feet/1.8 meters from the pole. If an expansion loop is required, attach the mechanical bender to the strand in the appropriate position (see Aerial Installation/3.4).

If you are cutting the cable, make sure to leave enough cable tail to accommodate any splicing, equipment or expansion loops.

PASSING THE POLE

Attach a lashing wire clamp far enough from the pole to accommodate an expansion loop or equipment. Open the lasher gates. Disconnect the set-up chute, pusher and lasher and pass them across the pole-face. Place them on the unlasher side far enough from the pole to accommodate an expansion loop or equipment and reassemble them.

Close the lasher gates. The lasher cannot be pulled backward along the strand while the gates to the lasher are closed. Cut the lashing wire and secure it to the lashing wire clamp. Make sure that the lashing wire does not loosen from around the cable.

Attach another lashing wire clamp to the strand on the unlasher side of the pole allowing enough distance for an expansion loop or equipment. Connect the wire from the lasher to the new clamp.

Place the cable in the set-up chute and the lasher.

Rotate the cable reel to take up any excess slack. Continue until the installation is complete.

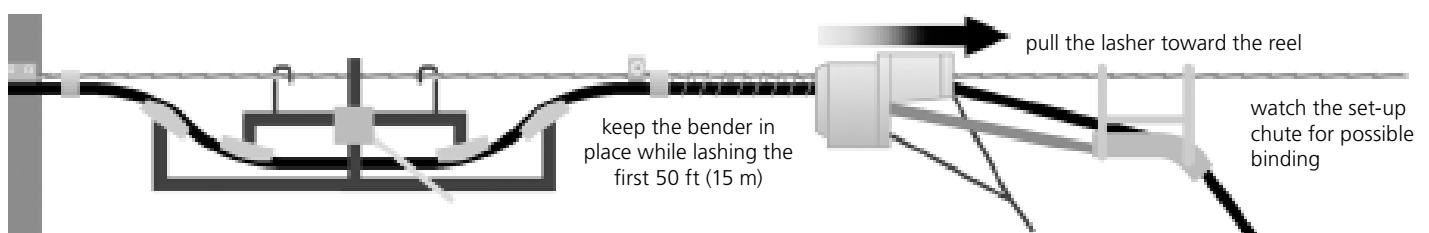

Installation - Overlashing Existing Cable

OVERLASH CABLE PLACEMENT

Overlashing cables onto existing cable plant is similar to installing cable onto new strand. However, there are some unique aspects:

A sag and tension analysis should be performed to see if the new cable load will overwhelm the strand.

Use special overlash cable puller blocks and continuously maintain and monitor the pulling line tension. Overlash cable pullers do not have a strand brake and will be pulled backward on the span by the tension in the cables being pulled.

Use cable blocks designed specifically for overlash applications. Place them onto the cable bundle with a cable block lifter and lift the cable with a cable lifter. During lashing, remove the cable blocks from the cable bundle with a cable block lifter.

DO NOT PUSH THE CABLE BLOCKS IN FRONT OF THE LASHER AS THAT MAY DAMAGE EXISTING CABLES.

Remove all straps and spacers from the existing cable bundle during lash-up. New straps and spacers may be required - check the old ones carefully to see if they need replacing.

Integrated Messenger Installation

The most cost effective and reliable coaxial installation is possible today by using CommScope's integrated messenger products.

Both our flagship QR® and traditional P3® products are available in integrated messenger designs, built to increase your aerial plant reliability while greatly reducing your installed costs.

HOW DO WE INCREASE YOUR PLANT RELIABILITY?

Integrated messenger plant is not susceptible to the same expansion and contraction concerns as lashed plant. The cable web binds the coaxial cable to the strand, so the two expand and contract as a unit. This is beneficial to the installer, since integrated messenger coaxial plant does not require the installation of expansion loops. The expansion loop, once removed, is also removed as a failure point.

Aerially installed coaxial cable is subject to many forces. These forces are developed due to wind and ice loading, materials expansion and contraction, and the cables own weight. Correctly installed cable will survive the brunt of these forces for years. Vibration and wind effects can strain the cable at pole passings, but by simply separating the cable from the strand at the pole attachment, radial cracks can be eliminated.

Down Guys

All down guys must be placed prior to tensioning the self-supporting cable.

Where grounding of down guys is required, it will be necessary to bond the down-guy to the strand.

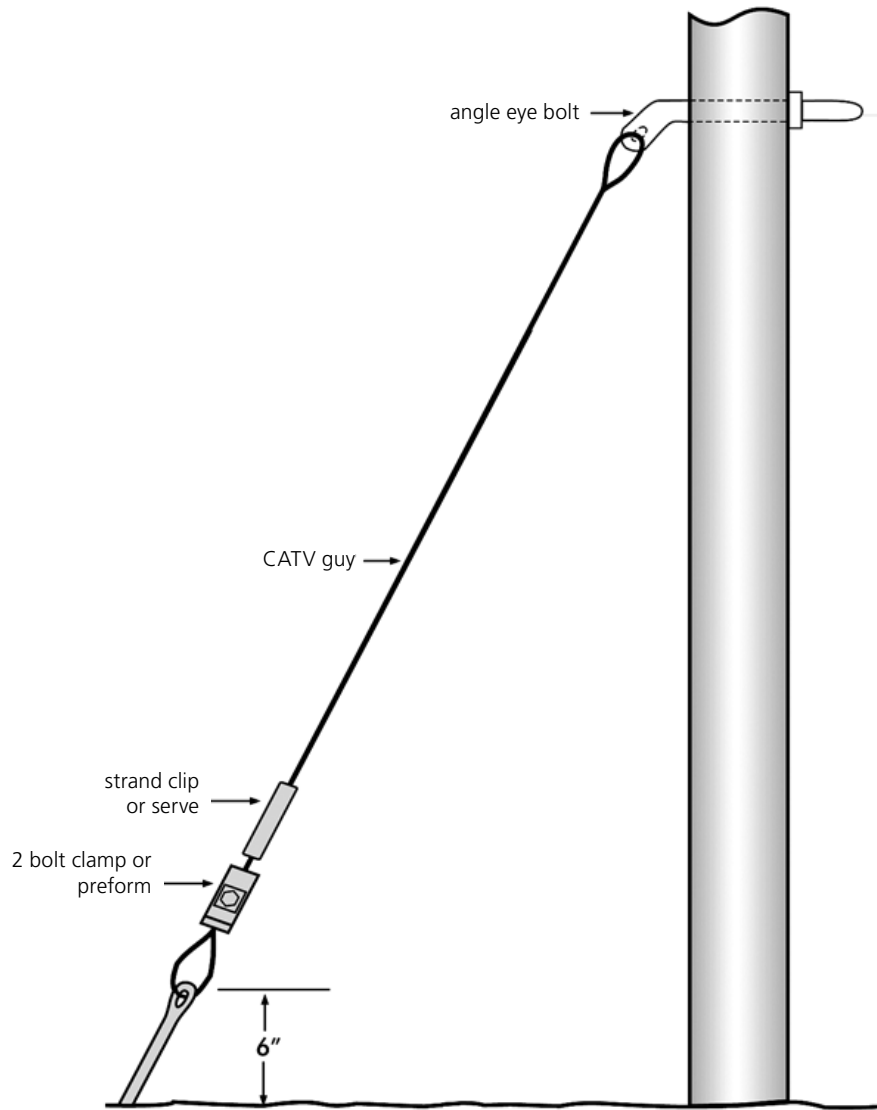

Hardware and Block Placement

Extension brackets, strand clamps and roller blocks should be in place prior to cable placement for each method described.

The C strand suspension clamp (shown at right) is used on jacketed strand. It is a three-bolt clamp with serpentine grooves to prevent slippage of the jacketed strand through the clamp. The suspension clamp must be a type recommended for the size of strand used. It must be placed so the strand groove is below the suspension bolt.

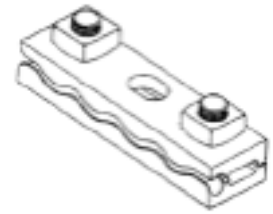

Strand Suspension Clamp

Place a cable chute on the first pole using a B or C frame without the swivel bracket.

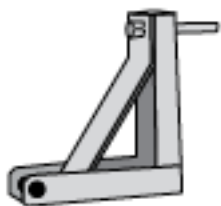

B Frame

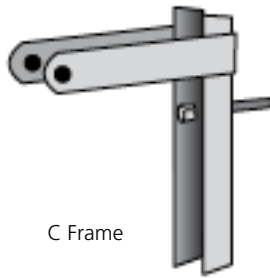

C Frame

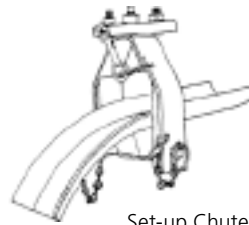

Set-up Chute

USE A BOLT THROUGH THE CHUTE MOUNTING BRACKET IN PLACE OF THE SWIVEL BRACKET ON THE B OR C FRAME.

PLACE A POLE MOUNT BLOCK OR EQUIVALENT ON ALL IN LINE POLES. BLOCKS AND FRAMES LISTED PREVIOUSLY MAY ALSO BE USED.



pole mount block

Use a multiple roller block for 45 and 90 degree angles.

Place a non-metallic pull line in the roller blocks.



90° block

Moving Reel Method

The moving reel method of placing self-supporting cable is used where a cable reel can be moved along side the pole line and there are no obstructions to prevent the cable from being raised into position.

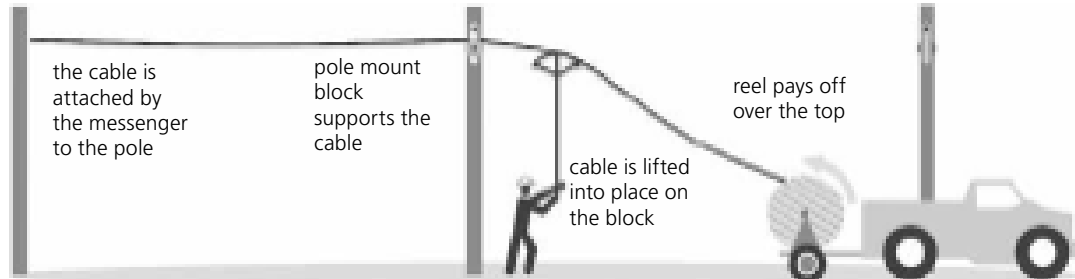

LOADING THE CABLE REEL

Load the cable reel so the cable is payed-out from the top of the reel. Use one of the blocks and frames pictured on page 4.3 for this placement method. If trees or other obstructions restrict the use of this method for a few sections close to either end of the run, proceed as follows. Pull the cable beyond the obstruction and lift into place. Resume the moving reel method once the obstruction is cleared. Where it is necessary to clear street or driveways use a Strand Puller attached to the pole with a sling. Do not remove the strand puller until the cable has been pulled to final sag at the dead ends or tensioning locations.

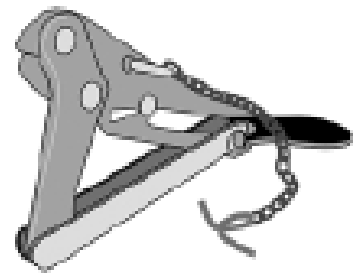

strand puller

Note: The cable and strand must be separated before using a strand puller to prevent damage to the cable. A strand dead end or wire vise may be used to pull IM cable with.

CAUTION: DO NOT USE J HOOKS TO PLACE IM CABLE. COAXIAL CABLE SHOULD NEVER BE PULLED OVER PLACING HOOKS.

PLACING THE CABLE IN BLOCKS

If a bucket truck is not available, the cable should be raised into place using a cable-lifting tool.

DO NOT TENSION CABLE AROUND CABLE BLOCKS. TENSION SHOULD ONLY BE APPLIED FROM CORNER POLES OUTWARD.

Stationary Reel Method

When self-supporting cable will be placed from a stationary reel, all strand hardware, cable blocks, frames, and down-guys must be in place.

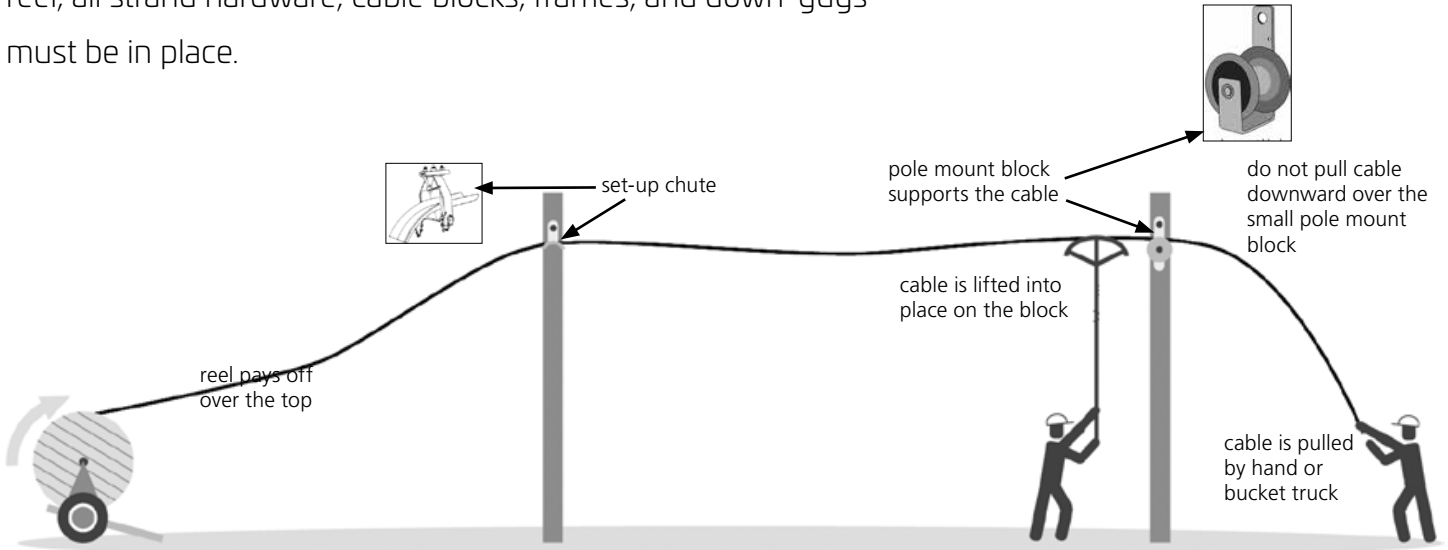

LOADING THE REEL TRAILER

Load the cable reel onto the trailer so the cable is payed-out from the top of the reel.

POSITIONING THE REEL TRAILER

When using the back pull or stationary reel method of placement the trailer should be placed back from the pole two times the distance of the attachment height. The center of the cable reel should be as near inline with the strand line as possible to prevent the cable from rubbing the reel flanges. Also, locate the trailer so the cable will not rub the pole face as it is being pulled. For a straight pull, the reel can be set-up at either end. However, it is advisable to pull in the same direction as traffic flow. The cable reel should always be located at the end nearest a 45/90-degree pull to reduce tension.

PULLING THE CABLE

Prepare self-supporting cable for pulling by separating the strand and cable with a web-slitting tool. Remove the jacket from the strand. Removal length will depend on the length of the strand grip or pulling device. Place the pulling grip of choice on the strand and then tape the cable to the grip. Tape the cable end in a taper so it will not lodge on the rollers or attachments.

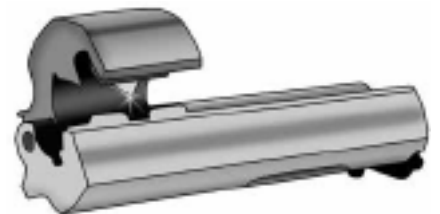

Ripley Cablematic - MWS-xxx

Attach a swivel between the grip and pull line. Pull by the messenger only! Start each pull very slow to remove slack in the pull line and cable. Never start with a sudden jerk, as this will damage the cable at the blocks. While pulling, monitor the cable for binding in the blocks/rollers, and rubbing against the poles. Use cable reel brakes as necessary. During the placing operation do not exceed the maximum rated pulling tension of the steel. After the cable has been placed, tension should be applied to the strand only. Follow clearance guidelines found in the current NESC Rules 250-252. Use SpanMaster® to calculate/verify sag and tension.

STRAND DIAMETER		WEIGHT		MAX. RATED LOAD	
INCHES	(MM)	LBS/FT	(KG/M)	LBS	(KG)
0.109	(2.77)	0.032	(0.048)	1800	(816)
0.134	(3.40)	0.048	(0.075)	2680	(1216)
0.188	(4.77)	0.073	(0.109)	3990	(1810)
0.250	(6.35)	0.121	(0.180)	6650	(3016)

Note: When placing above or between existing plant, match sag.

Cable and Strand Separation

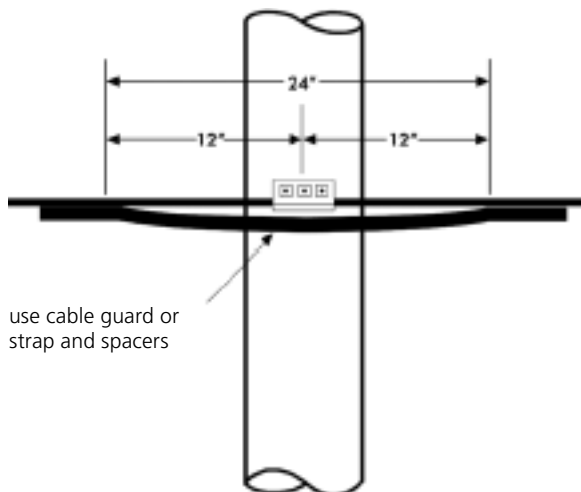

use cable guard or strap and spacers

Note: Prior to placing the strand in the clamps, the cable and strand must be separated using the MWS-xxx tool.



Ripley Cablematic - MWS-xxx

Tensioning

The length of self-supporting cable that can be tensioned at one time will depend on several factors such as corners, span length, changes in grade, and maximum pulling tension. However, lengths up to 1000 feet can generally be tensioned satisfactorily in straight sections of pole line. Use a chain hoist, strand puller, and sling to remove slack and tension the strand. The strand puller can be used over jacketed steel.

Note: Strand and cable at corner poles and grade changes should be in the clamps or dead ended prior to tension being applied.

When the span/s are tensioned and sagged, move from pole to pole separating the steel and cable prior to clamp placement.

CAUTION: TO PREVENT DAMAGE TO THE CABLE, SEPARATE THE CABLE AND STEEL BEFORE USING A STRAND PULLER. THE PIN ATTACHING THE SAFETY CHAIN WILL CAUSE SEVERE DAMAGE TO THE CABLE.

A tensiometer may be used to monitor tension on the strand. The tensiometer is placed between the hoist and strand puller so the tension can be read directly from the scale as the cable is being sagged. This method is very useful on long lengths to prevent undue stress on the steel. See steel strand specifications table in section 4.6.

CAUTION: PERMANENT DOWN GUYS SHOULD BE IN PLACE AT THE FIRST, LAST, AND ANY INTERMEDIATE POLES BEFORE TENSIONING TO FINAL SAG TO PREVENT UNBALANCED LOADS.

All spans should be tensioned and placed in clamps during the workday.

DO NOT LEAVE THE CABLE SUSPENDED IN ROLLER BLOCKS FROM ONE WORKDAY TO THE NEXT.

Dead Ending

Self-supporting cable is dead-ended at the first, last, and corner poles. For stranded steel attach with a Strand-Dead End (Preform), for solid steel messengers use a wire vise. Sufficient cable and strand separation will be required at dead-end poles to allow for splicing if necessary. Note: A corner pole is defined as having an angle of 30° or greater from the pole line. The strand must be dead-ended or false dead-ended at corner poles in both directions. If the strand continuity is broken, bonding will be required at this time.

Note: It is not necessary to cut the strand if B false dead ends are used.



strand-dead end

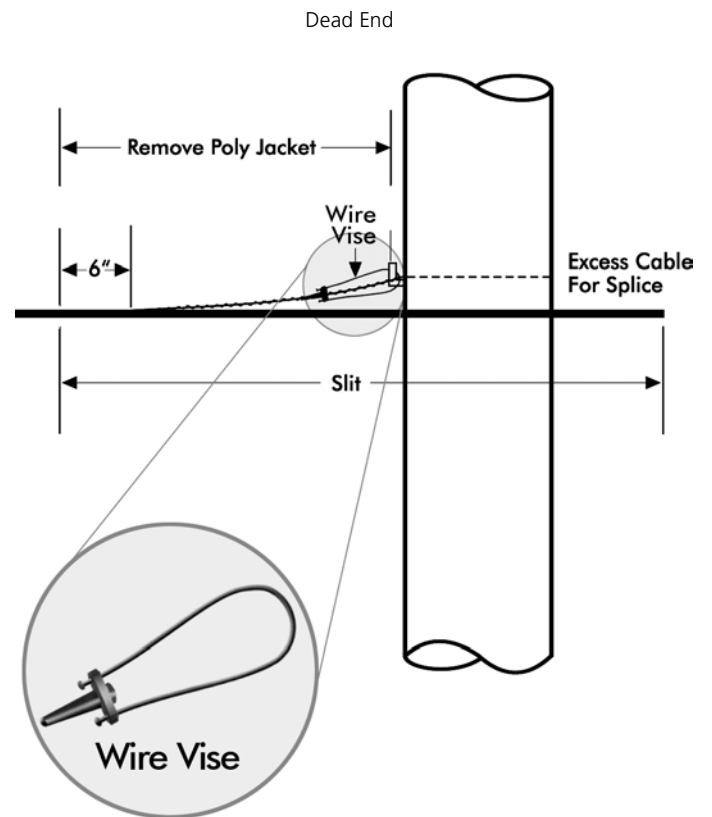

Cable and Strand Separation

Note: At the time of tensioning the cable and strand must be separated before making permanent attachment.

When a Strand Vise or Strand Grip is used on IM at dead-end locations, the cable, and strand must be separated in the web. The web should be slit to a point 6 inches beyond the far end of the vise or strand grip.

Note: Do not use a utility knife for slitting the web on IM Cables.

Remove the poly jacket from the steel and attach the grip. Make sure the sag is correct before cutting the excess steel.

Note: It is not necessary to remove the tar flooding from the steel if present.

USE CABLE GUARD OR SPACERS AT ALL HARDWARE LOCATIONS.

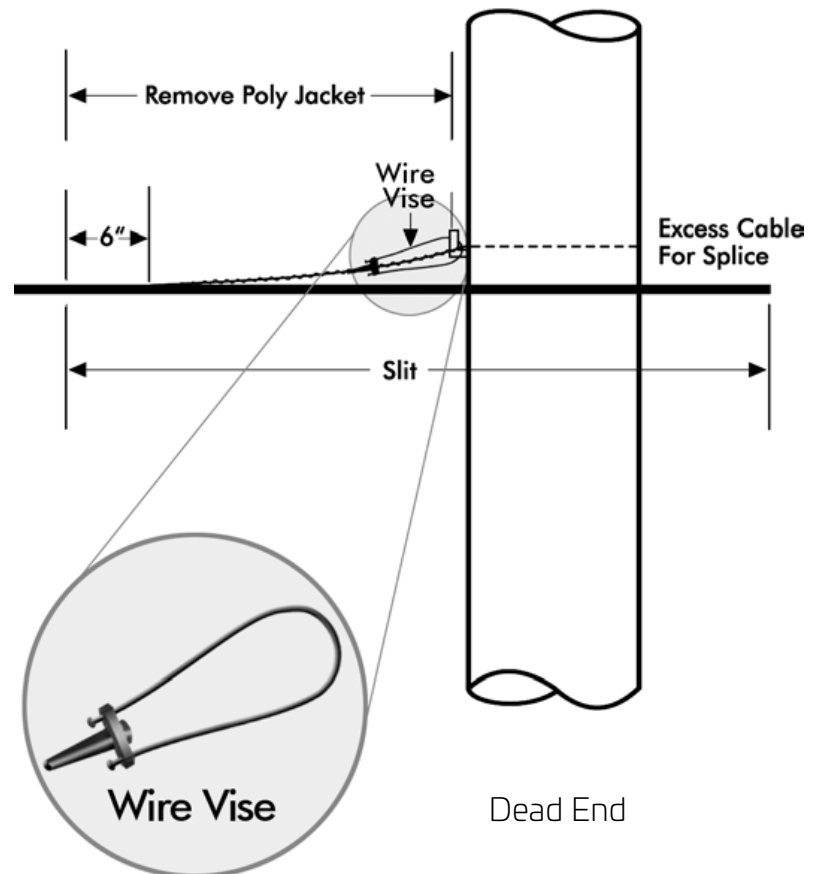

Pole Attachment

After the self-supporting cable has been placed and properly tensioned, it must be attached permanently. Any twist (360° rotation) in the IM cable should be removed at this time.

The "C" Cable Clamp can be used for attaching the jacketed strand on QR. This is a 3-bolt clamp with serpentine grooves to prevent slippage of the jacketed strand. Install the clamp after the web has been slit.

Splicing

SEPARATING CABLE AND STRAND

Measure from the clamp center bolt out 24 inches plus the width of the device plus another 24 inches beyond the device. Mark the cable at these locations for separation. Consult your company methods and procedures for equipment placement prior to installation.

Use the appropriate size web slitting tool to separate the steel and cable.

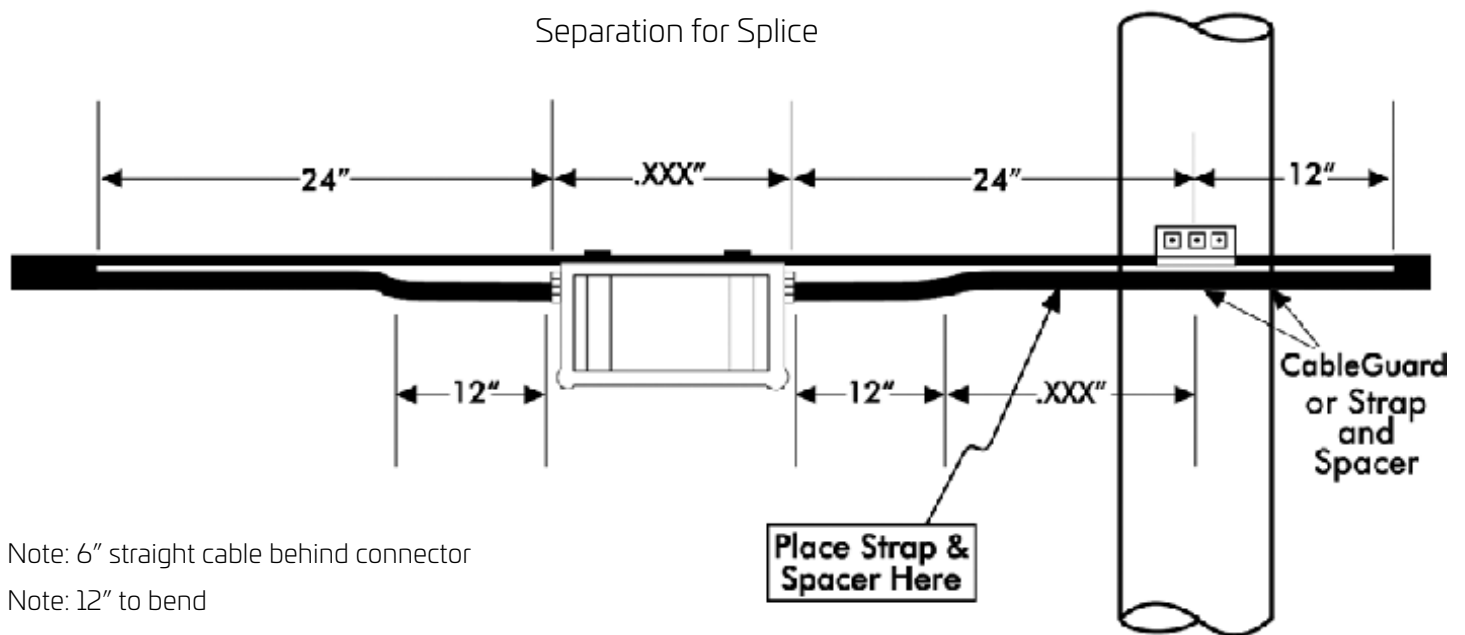

Note: 6" straight cable behind connector

Note: 12" to bend

Note: 24" without expansion loop

Temporarily hang the device on the strand and cut the cable center of the device or if the device location was marked cut in the center.

Note: Do not remove any cable at this time.

Expansion loops are optional. An expansion loop will provide excess cable for future terminations.

A minimum of 24 inches separation is required at each pole passed. Measure from the clamp center bolt twelve inches from each side.

WEB REMOVAL

The web must be removed on QR products leaving a smooth round cable for splicing.

Note: Do NOT use a knife. Prior to removing any cable, remove the web. The web on QR can be removed the length of the separation or 2 inches beyond the shrink tube length.

Ripley-Cablematic MWSS-xxx



Minimum Separation at Pole Passing

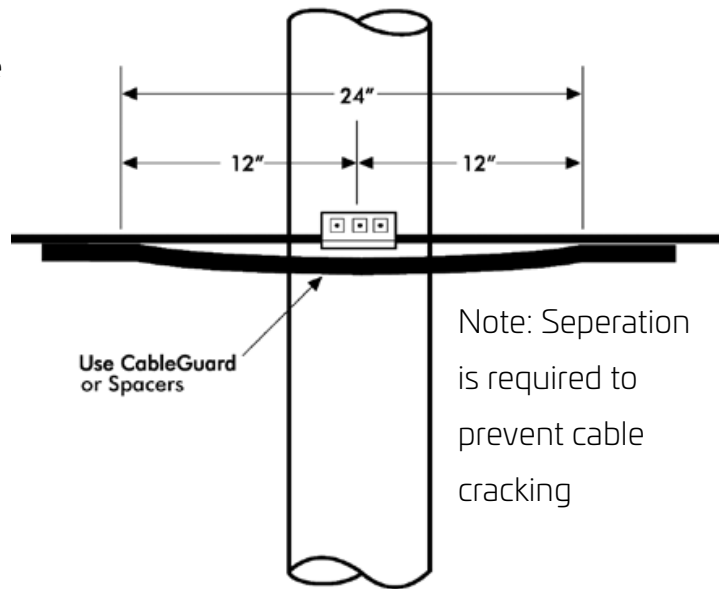

CABLE TRANSITION

Attach the device to the strand with main body of connectors installed. Make the cable transition into the device. A minimum of 6 inches of straight cable must be maintained behind the connector to allow for splicing and flexing.

Note: Start on the span side.

When hand forming the transition into the equipment, do not exceed minimum bend specification.

Cable Transition



Underground Installation of CommScope Cable

There are several cable types built specifically for underground installation:

QR/P3JCASS with Migra-Heal® flooding compound between the shield and jacket

QR/P3JACASS with twin polyethylene jackets separated by corrugated chrome plated steel armor ConQuest® CommScope cable pre-installed in a tough high-density polyethylene conduit for Cable-in-Conduit direct burial. Please consult our Conduit Applications and Construction Manual.

The three methods for direct burial are vibratory plowing, trenching and boring.

VIBRATORY PLOWING is the most popular method. A plow with a special blade slices through the ground. The cable runs through a tube in the blade and is placed as the plow moves forward. Since no dirt is displaced, vibratory plowing is much less intrusive than trenching.

TRENCHING involves digging or plowing a trench, placing the cable in it and then burying it.

BORING (directional and conventional) digs or punches a hole in the earth, usually from one trench to another. It is an excellent method for crossing areas that cannot be plowed (such as paved roads or railroad tracks) if they cannot be traversed aerially. Cable is then pulled through the hole.

CommScope cable may also be pulled through existing underground conduit or ductwork. As with aerial installation, careful attention must be paid to not exceeding the maximum pulling force or the minimum bend radius.

QR pulls through ducts
with less effort than
any other coaxial cable

Pulling Tension

Pulling tension for CommScope cable types are shown in this chart.

CABLE	MAX. PULLING TENSION LBS / KGF
QR 540	220 (100)
QR 715	340 (154)
QR 860	450 (204)
P3 500	300 (136)
P3 625	475 (216)
P3 750	675 (306)
P3 875	875 (397)

NEVER EXCEED THE MAXIMUM PULLING TENSION

Excessive forces applied to the cable will cause the cable to permanently elongate. Good construction techniques and proper tension monitoring equipment are essential. The highly flexible nature of QR cable makes it very difficult to exceed the maximum pulling tension.

Tail loading is the tension in the cable caused by the mass of the cable on the reel and reel brakes. Tail loading is controlled by two methods. It can be minimized by using minimal braking during the pay-off of the cable from the reel - at times, no braking is preferred. Tail loading can also be minimized by rotating the reel in the direction of pay-off.

Break-away swivels should be placed on each cable to ensure that the maximum allowable tension for that specific cable type is not exceeded. The swivel is placed between the cable puller and pulling grip. A break-away swivel is required for each cable being pulled.

Dynamometers are used to measure the dynamic tension in the cable. These devices allow continuous review of the tension and accordingly a realization can be made of any sudden increase in pulling tension.

QR's flexible construction means longer runs and more 45°/90° bends are possible

Bending Radii

Cables are often routed around corners during cable placement and pulling tension must be increased to apply adequate force to the cable to bend the cable around the corner. Tension is directly related to the flexibility of cable - and flexibility is QR's greatest strength. CommScope's specified minimum bending radius is the static (unloaded) bending radius of the cable. This is the minimum radius to which the cable can be bent without electrically or mechanically degrading the performance of the cable. Bending the cable in this manner is usually only done during splicing or final forming. This is also the radius allowed for storage.

QR's shield construction permits the tightest bend radius in the industry

ALWAYS REVIEW THE SPECIFICATIONS FOR THE APPROPRIATE BEND RADIUS. IF YOU DO NOT EXCEED THE MINIMUM BEND RADIUS NOR EXCEED THE MAXIMUM PULLING TENSION, YOU SHOULD HAVE A SUCCESSFUL INSTALLATION.

CABLE	MINIMUM BENDING RADIUS IN/CM
QR 540	4 (10.2)
QR540 Armored	6.5 (16.5)
QR 715	5 (12.7)
QR 715 Armored	7.5 (19.1)
QR 860	7 (17.8)
QR 860 Armored	9.5 (24.1)
P3 500 standard (jacketed)	6.0 (15.2)
P3 500 bonded (jacketed)	3.5 (8.9)
P3 625 standard (jacketed)	7.0 (17.8)
P3 625 bonded (jacketed)	4.5 (11.4)
P3 750 standard (jacketed)	8.0 (20.3)
P3 750 bonded (jacketed)	6.0 (15.2)
P3 875 standard (jacketed)	9.0 (22.9)
P3 875 bonded (jacketed)	7.0 (17.8)

The bending radii of cables during the construction process are controlled by the radii of the bends in duct or conduit as well as construction techniques and equipment.

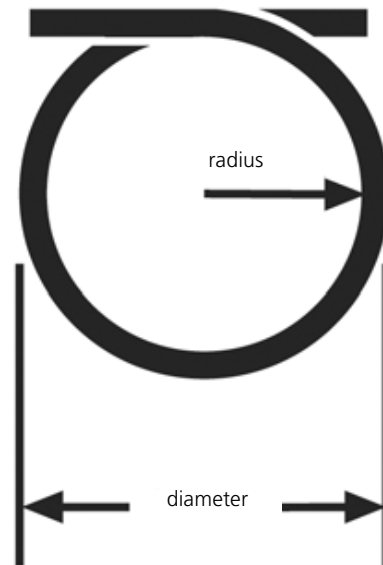

Underground Installation - Vibratory Plowing

Vibratory plowing offers substantial productivity gains over other direct burial methods. A tractor moves slowly forward as a vibrating blade splits the earth and places the cable at the required depth. Because terrain and soil types vary, contact your plow manufacturer for their equipment recommendation. We strongly recommend a professionally engineered single or double feed tube plow blade with a tube at least 1/2 inch (1.3 cm) larger than the largest cable size and a radius of 12 in (30 cm) or larger. At minimum, an operator and a helper/feeder are needed for a plowing installation.

Dig a trench deep enough and at least twice the length of the plow blade/chute for the plow blade to enter it comfortably. A similar trench should be dug at the other end of the installation. The cable may pay-off from the front of the tractor or from a stationary cable reel.

In the tractor method, make sure the reel is not run into objects that may damage the cable. Pay the cable over the top of the reel. Do not use reel brakes.

In the stationary reel method, pull the cable end from the reel to the ending trench. Use safety cones to mark and protect the cable from pedestrian and vehicle traffic.

Cap or tape the cable end. Remove the back plate from the blade

and inspect the feed tube for burrs, rough surfaces and sharp edges. Clean out any dirt or rocks. Carefully place the cable in the feeder tube. Reattach the back plate.

Carefully pull enough cable through the blade to allow for splicing, etc. Have someone hold the cable end to keep it from being pulled as the tractor initially moves forward. Start the vibrator after forward movement begins. Have the blade in solid contact with the earth before applying full RPM.

DO NOT VIBRATE IN PLACE FOR MORE THAN 30 SECONDS.

A worker must manually guide the cable into the plow blade.

Underground Installation - Vibratory Plow Movement

HANDLING OBSTRUCTIONS

If obstructions (tree roots, large rocks, etc.) are encountered, disengage the transmission, turn the engine off and then disengage the clutch. **NEVER BACK THE PLOW WITH CABLE IN THE FEED TUBE.** This will damage the cable and pack dirt into the feed tube.

Carefully dig a pit behind the blade. Remove the cable, then remove the obstruction. Replace the cable and proceed with the installation.

Although aggressively steering and lifting/lowering the blade are considered poor practice, these techniques can be used as long as extreme caution is exercised.

TURNING

Gentle turns can be made over a distance of 5 - 8 feet (1.5 - 2.4 meters). Never turn the blade unless the tractor is moving forward. Some manufacturers make steerable blades.

LIFTING THE BLADE

If absolutely necessary (for instance, avoiding a buried utility line), the blade can be gradually raised at a rate of 8 inches (20 cm) over a 5 foot (1.5 meter) run. Lower the blade at the same rate once the underground hazard has been passed. Do not raise the blade to ground level with cable in the feed tube.

Trenching

Trenching is accomplished with specialized trenching tractors which cut the trench and remove the soil in a single action.

A trench can be used to place multiple cables over long or short distances. Detailed equipment operation and excavation procedures are specified by the construction equipment manufacturer.

All bores and crossings should be installed prior to the start of the trenching process.

Excavate the trench to the desired depth. Remove all rocks and large stones from the bottom of the trench to prevent damage to the cable. Push some clean fill into the trench to cushion the cable as it is installed in the trench.

Supplemental trenches should be made to all offset enclosure locations. Trench intersections should be excavated to provide adequate space to make sweeping bends in the cable/conduit.

Place the cable trailers or cable reels in line with the trench to prevent any unnecessary bending of the cable. Pay the cable off the bottom of the reel.

When routing cables to enclosure locations, leave adequate cable lengths for splicing. Bend the cables carefully around corners and upward at enclosure locations. Cap the cable as needed.

Bury warning tape above the cable during the back-fill process.

Fill the trench and compact it as required. Tamp or flood the trench to provide compaction that will prevent the trench from receding.

Boring and Conduit Installations

CONVENTIONAL BORES

Mechanical boring machines may be utilized to push a drill stem to make an adequate cable passage. Pneumatically driven pistons may be used as well. Conduit should be placed to support the tunnel wall and allow cable placement.

DIRECTIONAL BORES

Directional boring is accomplished by using a steerable drill stem. The depth and direction of the boring can be controlled by the equipment operator. Very long bore lengths can be accomplished by using directional boring devices.

Subsurface crossings are generally accomplished by digging a trench on each side of the crossing to allow the guiding and retrieval of the drill stem. Detailed equipment operation and excavation procedures are specified by the construction equipment manufacturer.

Generally, try to keep the bore as straight as possible. The hole may be enlarged by using reamers. Conduit should be installed at strategic locations (i.e. street crossings).

After the bore is complete, attach the cable to the drill stem with the appropriate cable grip and swivel. Pull the drill stem/cable through the bore. Longer pulls will require tension monitoring.

Installing CommScope Cable into Conduit

Cable can be pulled in new or existing conduit. New conduit should be installed in as straight a path as possible - undulations in the conduit system increase pulling tensions due to sidewall pressure. Existing conduit systems generally require some maintenance prior to placing cables into the conduit. Use a rodding machine to remove unwanted debris and water from the conduit.

A cable route survey will dictate the cable placement scheme which should account for the difficulty of the pull, manpower and equipment availability.

The curve radii in the conduit systems should be large enough to prevent excessive pulling tension due to sidewall friction. Very small radius bends may prevent even a cable as flexible as QR from being successfully pulled.

BLOWING OR JETTING CABLE

This process uses a combination of air pressure and a small drive to push the cable through a conduit. It is most effective when placing a single cable. Since the cable is not pulled, pulling tension is not a concern.

Position the reel so that pay-off is from the top and is in as straight a line as possible with the entrance to the duct. A small caterpillar drive pushes 150 - 200 feet (45 - 60 meters) of cable into the conduit. Air is then forced into the conduit and the jetting action helps propel the cable with minimum effort.

With this method, a flexible cable like QR 860 can be pushed through 7 - 8 90° sweeps over a 1500 foot (450 meter) distance of 2 inch (5 cm) rigid PVC conduit.

Coaxial Bonding - Optimizing Preparation and Connectorization

Hardline coaxial cables have been used in the broadband industry for decades. During these years many refinements were made to these cables to produce the optimal cable electrical and mechanical performance. Today, with a better knowledge of processes and recent advancements in material, cables are again being further optimized.

- Enhanced Mechanical Performance
- Meets/Exceeds ANSI/SCTE, EN50117, IEC and Cenelec Specifications
- Fully Backward Compatible
- Identical Electrical Performance
- Patent Pending



INTRODUCTION

Coaxial cables have several interface areas between metals and plastics. Each of these interfaces offers a unique set of issues to the user and manufacturer, all related to the bonding of the plastics to the metals. It is bonding that enhances the mechanical performance of a coaxial cable; enabling improved bend performance, core retention, and inhibiting moisture migration. Just as essential as the cable's mechanical performance is the ability to properly prepare and connectorize a cable. There must be a balance to achieve both with optimal results. This paper will provide an understanding of what trade-offs are made when going to the extremes in bonding, preparation performance, and the optimal zone for a cable to be in.

INDUSTRY STANDARDS

To assure a cable's performance for the user, the industry has adopted standardized test methods and minimum specifications for defining the bond characteristics of coaxial cable.

As a starting point, the SCTE in its "Specification for Trunk, Feeder and Distribution Coaxial Cable" [ANSI/SCTE 15 2001] specifies minimum bond strength between the dielectric and the center conductor defined as "Dielectric Shear Adhesion". The bond strength values vary with cable size, with larger cables having higher bond strength requirements than smaller cables.

CABLE TYPE	BOND STRENGTH MINIMUM POUND FORCE
P3	
500	60
625	80
750	90
875	86
QR	
540	68
715	90
860	96

ANSI/SCTE 15 2001 - Table 10.0

Typical bond strengths of today's cables well exceed these minimum requirements, being as much as 100% above that specified by ANSI/SCTE. Such a conservative approach is understandable given that there was no cost penalty to create a bond that performed at such a high level, and that operating at that level eliminated any potential for poor performance due to low bond strength. With excessively high bond strengths, controlling the consistency of the cable's quality is less demanding. The negative impact of this for the cable's user is a difficult preparation and connectorization process.

At the other end of the spectrum are poorly bonded cables that do not meet the specified ANSI/SCTE requirements. The typical cause of low bond strength is attributed to the inability to control a consistent manufacturing process. The negative impact of this for the cable's user is poor core retention, moisture migration, and poor bend performance (kinks easily).

As an example, a P3 500 cable size has a minimum bond strength requirement of 60 lbs, while a P3 750 cable size has a requirement of 90 lbs.

Additional important attributes of the bond are identified in this specification. First, a "Dielectric Shrinkback" requirement in which the shrinkback of the dielectric shall shrink no more than 0.250 inches (6.35 mm) from both ends of the sample following test procedure ASTM D 4565. Second, is the "Cable Static Minimum Bend" tested following ANSI/SCTE 39 2001.

There is an operating range, though, in between these two extremes of performance that facilitates a dielectric bond that will cleanly break away from the center conductor without sacrificing the mechanical aspects of the cable.

CommScope has developed, ACT (Advanced Coring Technology), a patent-pending bonding technology that operates in this window between the extremes. As shown in the chart in Figure 1, it exceeds the SCTE requirements for bond strength and provides for a clean and easy removal of the bonding material.

With this technology, the force exerted by the coring tool is sufficient to cause the dielectric to break away from the center conductor, leaving a clean conductor that typically does not require a second dielectric removal step. The tool and the craftsman can influence this enhanced performance characteristic of the cable, making a one step coring highly repeatable.

In addition to bond strength, the bonding agent also maintains the other key performance criteria of the cable as called out in the SCTE specification. Some of those criteria are listed in Table 1.

Overall this solution provides all of the benefits of water migration deterrence, corrosion prevention, and mechanical performance while eliminating the performance risks associated with center conductor dielectric removal.

SUMMARY

The bond strength in cable is critical to the mechanical performance of the cable. However, bonding affects more than just the cable's mechanical characteristics, it also impacts the facilitation of cable preparation and connectorization. Finding the balance of bond strength and craft friendliness is accomplished by the development of an advanced technology bonding agent and coupling it with CommScope's consistent manufacturing process controls. This achievement enables the cable to mechanically behave the way it needs to and makes the preparation easier.

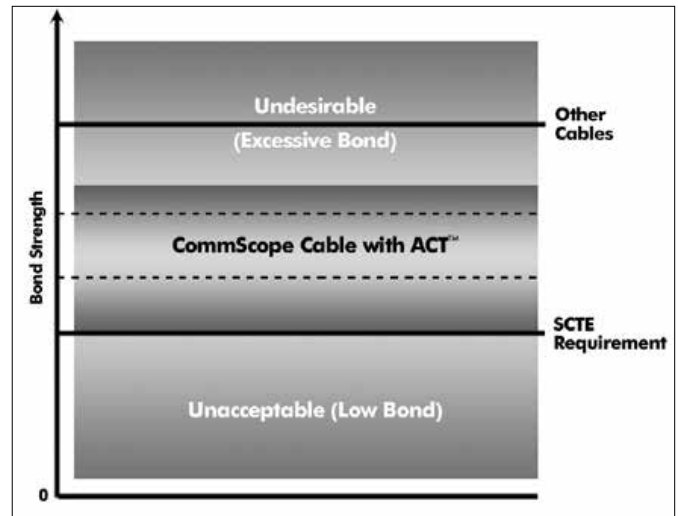

Table 1 – Cable performance with ACT.

MEASURE	PASSES SCTE REQUIREMENT
Center Conductor Bond Strength	✓
Center Conductor Corrosion	✓
Water Penetration	✓
Air Transmission	✓
Dielectric Shrink Back	✓
Velocity of Propagation	✓
Attenuation	✓

Table 1 – Cable performance with ACT.

Cable Preparation with ACT[®]

P3[®] with ACT[™] and QR[®] with ACT[™] cables were developed to address a question that has been clearly stated and often repeated by the craftsmen, engineers, and technical operations managers of the broadband industry.

Why must a hardline cable be so difficult and problematic to properly core and prep?

INTRODUCTION

Traditional coaxial trunk and distribution cables require considerable attention to the preparation of the cable end for proper connectorization. Critical to that end, preparation is the proper removal of dielectric and bonding compound from the conductors.

The normal process requires the craftsman to first core the cable and then clean the center conductor in a second step.

CommScope's new patent pending P3[®] with ACT[®] and QR[®] with ACT[®] cables virtually eliminate the center conductor cleaning step by enabling a clean coring process in which the center conductor is cleaned of dielectric and bonding compound during the coring process.

With this technology, the force exerted by the coring tool is sufficient to cause the dielectric to break away from the center conductor, leaving a clean conductor that typically does not require a second dielectric removal step. The tool and the craftsman can influence this enhanced performance characteristic of the cable.

These cables meet and exceed all ANSI/SCTE, EN50117, IEC and Cenelec testing methods for trunk, feeder, and distribution cables.

This paper is intended to provide the craftsman with the understanding of how the cable is different and how to optimally prepare cable with Advanced Coring Technology[®].

What Makes ACT So Different?

Typical bond strengths of today's cables well exceed the minimum requirements, being as much as 100% above that specified by ANSI/SCTE. At the other end of the spectrum are poorly bonded cables that do not meet the specified ANSI/SCTE, EN50117, IEC and Celelec requirements.

There is an operating range, though, in between these two extremes of performance that facilitates a dielectric bond that will cleanly break away from the center conductor without sacrificing the mechanical aspects of the cable.

CommScope has developed ACT, a patent-pending bonding technology that operates in this window between the extremes. As shown in the chart in Figure 1 (on page 6.3), it exceeds the SCTE requirements for bond strength and provides for a clean and easy removal of the bonding material.

In addition to bond strength, the bonding agent also maintains the other key performance criteria of the cable as called out in the SCTE specification. Some of those criteria are listed in Table 1 on page 6.3.

Overall this solution provides all of the benefits of water migration deterrence, corrosion prevention, and mechanical performance while eliminating the performance risks associated with center conductor dielectric removal.

Getting a Clean Core

To take advantage of an ACT cable's unique clean coring capabilities there are a couple of simple "Best Practice" procedures that the splicer must understand and put into practice.

DRILL CORING – To enable the tool to optimize its shearing force while coring:

- Keep the RPM's below 450 (low speed)
- Apply slightly more forward pressure than usual for about the first ¼ inch of the core, then resume normal forward pressure
- Some will find it easier to "trigger" the drill in short 1-2 second bursts for about the first ¼ inch of the core, replicating a hand core action, rather than controlling a constant low drill speed

HAND CORING

– While not the preferred method of most splicers, it does provide a consistent clean core operation without any special needs.

Most standard tools are able to provide the proper shearing force necessary to facilitate a clean core. However, a splicer may find that they have a tool that does not provide a consistent clean core. In the event that this occurs, ACT cables enable the splicer to easily remove the remaining bonding compound and dielectric with a traditional center conductor cleaning tool. This removal is accomplished with greater ease than was ever possible with traditional cables.

SUMMARY

The bond strength in cable is critical to the mechanical performance of the cable. However, bonding affects more than just the cable's mechanical characteristics, it also impacts the facilitation of cable preparation and connectorization. Finding the balance of bond strength and craft friendliness is accomplished by the development of an advanced technology bonding agent and coupling it with CommScope's consistent manufacturing process controls. This achievement enables the cable to mechanically behave the way it needs to and makes the preparation easier.

With some simple "best practice" procedures, a splicer will find it easy to consistently achieve a one step clean core.

Below is an example of traditional P3® cable



Residual dielectric and bonding compound on conductor after coring

Below is an example of P3® cable with ACT®



Conductor clean of dielectric and bonding compounds after coring

P3[®] Connectorization

USE THE RIGHT TOOLS: a P3 coring tool, a P3 jacket stripper, a file, center conductor cleaning tool, wrenches sized for the connectors (adjustable wrenches are fine) and cable cutters. A hi-torque, low-speed drill or a ratchet are optional, but will speed the process. Wearing safety glasses and gloves are recommended.

PREPARE THE CABLE by using the cable cutters to trim the cable to a smooth, round end.

REMOVE THE JACKET using a P3 jacket removal tool. This tool rotates around the cable and removes jacket material without scoring the aluminum. A knife is not recommended for this process. Remove any MigraHeal[®] compound that may be on the shield.

REMOVE THE PROPER AMOUNT OF SHIELD AND DIELECTRIC with the P3 coring tool. Slide the cable into the tool until it stops. With slight forward pressure, twist the coring tool (either by hand or mechanically with the ratchet or drill) so that the blade begins to strip and core the cable. Continue to turn the coring tool until the proper trim dimensions are achieved. Clean the dielectric and shield residue from the tool.

CLEAN THE CENTER CONDUCTOR by using a non-metallic cleaning tool. Score the coating on the center conductor at the shield and scrape it toward the end of the conductor. The conductor is clean if the copper is bright and shiny. **DO NOT USE A KNIFE** or other metal tool as it may damage the copper cladding.

SLIDE THE SHRINK TUBING (HIGHLY RECOMMENDED) OVER THE CABLE END, THEN ATTACH THE CONNECTOR according to the manufacturer's instructions. Place and shrink the boot. Note: if you are using a heat-shrink boot, apply the flame carefully. Overuse of the torch may melt the jacket and dielectric.

QR[®] Connectorization

QR coring/stripping tools are designed for craft-friendliness and speed of operation. All QR connectors and tools are manufactured to meet CommScope specifications, therefore any QR tool can be used to prepare the proper-sized QR cable for any manufacturer's connector.

USE THE RIGHT TOOLS: a QR coring tool, a file, center conductor cleaning tool, wrenches sized for the connectors (adjustable wrenches are fine) and cable cutters. A hi-torque, low-speed drill or a ratchet are optional, but will speed the process. Wearing safety glasses and gloves are recommended.

PREPARE THE CABLE BY USING THE CABLE cutters to trim the cable to a smooth, round end. Remove the proper amount of shield and dielectric with the QR coring tool. Slide the cable into the tool until it stops. With slight forward pressure, twist the coring tool (either by hand or mechanically with the ratchet or drill) so that the blade begins to strip and core the cable. Continue to turn the coring tool until it spins freely - the tool has a preset stop that requires no adjustment. Clean the dielectric and shield residue from the tool.

CLEAN THE CENTER CONDUCTOR

by using a non-metallic cleaning tool. Score the coating on the center conductor at the shield and scrape it toward the end of the conductor. The conductor is clean if the copper is bright and shiny.

DO NOT USE A KNIFE or other metal tool as it may damage the copper cladding.

REMOVE THE CORRECT AMOUNT OF JACKET with the QR jacket removing tool. Slide the cable into the tool until the cable stops. Turn the tool clockwise to strip the jacket. Continue turning until it spins freely - the tool has a preset stop that requires no adjustment. Remove any Migra-Heal[®] compound that may be on the shield.

SLIDE THE SHRINK TUBING (HIGHLY RECOMMENDED) OVER THE CABLE END, THEN ATTACH THE CONNECTOR according to the manufacturer's instructions. Place and shrink the boot. Note: if you are using a heat-shrink boot, apply the flame carefully. Overuse of the torch may melt the jacket and dielectric.



Plant Maintenance

CommScope Cable actually requires very little maintenance once installed. However, periodic inspection may reveal small problems that can be corrected before they become large ones.

AERIAL TRUNK AND DISTRIBUTION CABLE AND CONNECTORS

Worn or broken lashing wire can create serious performance problems, such as wind-caused deformation which can impact the characteristic impedance of the cable. Loose lashing can also be the cause of jacket abrasion which can cause water to migrate through the cable and lead to its mechanical breakdown. If this sort of damage is detected, CommScope recommends that the entire span be replaced.

Replacing damaged connectors is best done with an extension connector. This is done because there is rarely any excess cable in the span. While it is tempting to use some of the cable in the expansion loop, to do so would degrade the loop and cause premature failure of the span.

UNDERGROUND TRUNK AND DISTRIBUTION CABLE

Check the plant periodically for signs of physical damage or any exposed shielding. Use a TDR to see if there is any sign of degraded performance at the point of suspected damage. Cover and protect any exposed shield. Replace any damaged cable.



Construction Safety Issues

Construction of a broadband cable system requires a substantial amount of manpower, tools and equipment.

Underground and aerial construction will expose the manpower, tools and equipment to hazards, dependent on field conditions and circumstances.

The Occupational Safety and Health Administration (OSHA) defines a qualified employee as “any worker who by reason of training and experience has demonstrated his ability to safely perform his duties.” Only a qualified employee should be assigned duties that could cause harm or potential harm to the construction crew, general public, cable plant, and other utilities.

This manual cannot identify the many hazards that exist in the construction environment, nor can it dictate the caution required with all of the tools, equipment and field conditions. CommScope continues this manual with the assumption that the construction personnel performing the work are qualified employees.

Three sets of national codes and standards apply to the construction of cable systems. Section 1910.268 of the OSHA Safety and Health Standards applies to work in telecommunications centers and field installations. The National Electric Code (NEC) applies to building utilization wiring, i.e. inside plant construction. The NEC applies specifically, but is not limited to, plant that is within or on public and private buildings or other structures. The National Electric Safety Code (NESC), generally applies to outside plant construction.

Municipal, state, county, and local codes are often applied to the construction of cable systems or work that involves their respective properties and right-of-ways. Pole Lease Agreements often stipulate specific practices related to safety.

These codes, regulations, and specified practices should be investigated, interpreted, communicated and observed.

The ability to recognize and avoid hazards is required of all construction personnel

Occupational Safety and Health Administration (OSHA) Standards

OSHA Standards were established in 1970 to help ensure workplace safety. The Standards are federal regulations that are intended to enable employers and employees to recognize, understand, and control hazards in the workplace. Standards have been established for general industry while some sections of the Standards are dedicated to specific industries such as telecommunications.



The generally applicable OSHA standards are found in:
Title 29 CFR Parts 1901.1 to 1910.441 General Industry, (OSHA),
Order No. 869-019-00111-5
Excavations (OSHA 2226), Order No. 029-01600125-5 Underground
Construction (Tunneling)
(OSHA 3115) Stairways and Ladders (OSHA 3124)

Copies of OSHA standards can be obtained from:
Superintendent of Documents
U.S. Government Printing Office
Washington, DC 20402
(202) 783-3238

National Electric Code (NEC) standards

The NEC typically identifies the construction techniques and materials necessary in building wiring requirements, i.e., inside plant construction, of fiber optic or coaxial cable systems. The NEC has been developed by the National Fire Protection Association's (NFPA's) National Electric Code committee. Committee members are professionals from the electrical industry. The NEC addresses safety from fire and electrocution. The NEC has been adopted by the American National Standards Institute (ANSI).

Copies of NEC standards can be obtained from:
National Fire Protection Association
1 Batterymarch Park/P.O. Box 9146
Quincy, MA 02269-3555
(800) 344-3555

NEC Articles 820

NEC article 820 deals with broadband coaxial cable. Traditional coax networks carry a low-voltage radio frequency (RF) signal. The voltage is so low that it is not considered dangerous. NEC article 820 is written with fire safety, not voltage, in mind.

LOOK FOR THE CABLE RATING ON THE JACKET. THE CABLE RATINGS ARE:

PLENUM-RATED CABLES, designed for use in plenums, ducts and air handling spaces, carry the strictest NEC rating.

RISER-RATED CABLES are used in vertical shafts that penetrate more than one floor. General purpose-rated cables may be used in locations other than plenums or risers.

GENERAL PURPOSE-RATED cables may be used in locations other than plenums or risers.

RESIDENTIAL-RATED CABLES are for use in one, two and multi-family dwellings and in raceways.

BURIED CABLES are for use underground alone or in conduit. This rating only concerns NEC 830 applications.

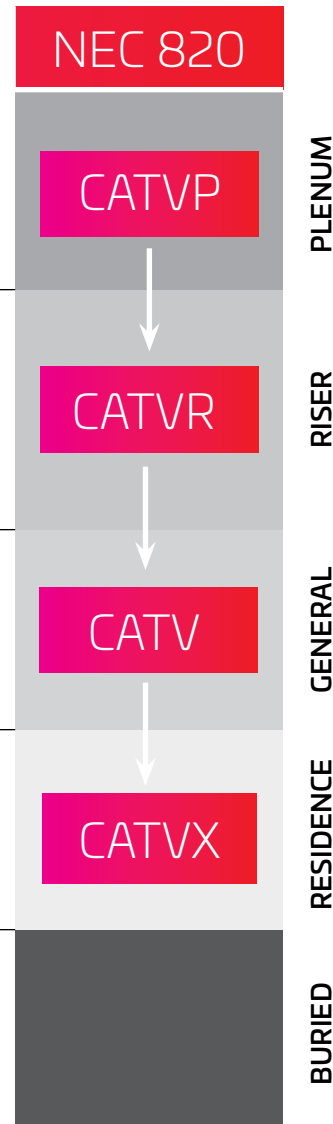

National Electric Safety Code (NESC) Standards and Construction Grades

The NESC defines grades of construction on the basis of strength requirements for reasons of safety. Section 24 of the NESC identifies construction grades B (the highest), C, D and N (the lowest).

Grade D construction typically applies to broadband coaxial cable and fiber optic cable. Construction grades B or C may be applicable dependent on the situations that exist. If more than one grade of construction applies to a situation, the higher grade will apply. A qualified engineer should evaluate required construction and dictate the grade of construction. The strength requirements for the various grades of construction are defined within Section 26 of the NESC.

The NESC typically identifies the construction techniques and materials necessary in outside plant construction of electric supply or communication cable systems. The NESC is an American National Standard that has been written by a group of professionals that are concerned about the Standard's scope and provisions. The NESC has been adopted by the American National Standards Institute (ANSI). All references to the NESC in this manual are from the 2002 edition.

Special attention should be given to NESC Table 232-1, Vertical Clearance of Wires, Conductors, and Cables Above Ground, Roadway, Rail, or Water Surfaces which is reproduced in part on the next page.

Copies of NESC standards can be obtained from:

IEEE Service Center
445 Hoes Lane/P.O. Box 1331
Piscataway, NJ 08855-1331
(800) 678-4333

NESC Table 232-1/Vertical Clearance of Wires

This chart shows the clearances required for a coaxial cable, isolated communication conductors and cable, messengers and surge-protected wire meeting NESC Rule 230C1, depending on the type of surface it is above. For a complete listing, please contact the NESC at the address on previous page.

SURFACE	MINIMUM DISTANCE FEET (METERS)
Railroad tracks (except electrified railroads using overhead trolley conductors)	23.5 (7.2)
Roads, streets, and other areas subject to truck traffic	15.5 (4.7)
Driveways, parking lots and alleys	15.5 (4.7)
Other land traversed by vehicles, such as cultivated, grazing, forest, orchard, etc.	15.5 (4.7)
Spaces and ways subject to pedestrians or restricted traffic only	9.5 (2.9)
Water areas not suitable for sailboating or where sailboating is prohibited	14.0 (4.0)
Water areas suitable for sailboating with an unobstructed surface area of:	
Less than 20 acres	17.5 (5.3)
Over 20 to 200 acres	25.5 (7.8)
Over 200 to 2000 acres	31.5 (9.6)
Over 2000 acres	37.5 (11.4)
Land adjoining water areas posted for rigging or launching sailboats with an unobstructed surface area of:	
Less than 20 acres	22.5 (6.8)
Over 20 to 200 acres	30.5 (9.3)
Over 200 to 2000 acres	36.5 (11.1)
Over 2000 acres	42.5 (12.9)

Pole Lease Agreements and other Codes and Regulations

POLE LEASE AGREEMENTS

Cable system operators often enter into contractual agreements with the owners of utility poles. The pole owners are municipalities, telephone companies, and power companies. There are often specific safety practices that are specified in the contract. These safety practices may be more restrictive than other codes and standards. The contractual agreements should be investigated for safety requirements. The requirements should be interpreted, communicated and accordingly observed.

STATE, LOCAL, AND MUNICIPAL CODES

State, local and municipal codes may also apply to the construction of the cable system. These codes will vary by location. These codes will have to be identified and applied as required on a location specific basis.

GOVERNING CODE OR REGULATION

The more restrictive code or regulation must always be practiced.

The most restrictive code or regulation is the one that must be practiced

Equipment/Benders and Dynamometers

MECHANICAL BENDER

Uses a mechanical wrenching action to bend expansion loops into QR cable prior to lashing or during splicing. Mechanical benders are preferred to bender boards due to the consistency of their bends.

For cables .625 or smaller, expansion loops should be formed with a bender that makes a 12" flat bottom loop that is 6" deep.

For cables larger than .625, expansion loops should be formed with a bender that makes a 15" flat bottom loop that is 6" deep.

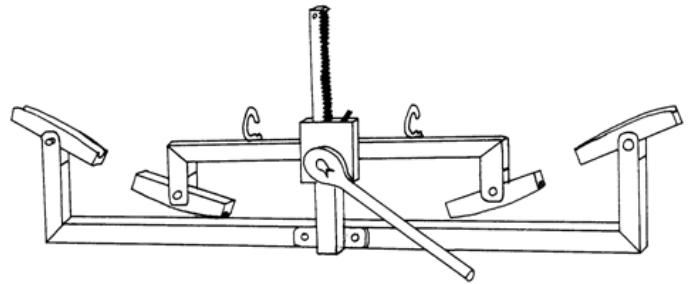

BREAKAWAY SWIVEL

Used to prevent excessive pulling tension. It is designed to break should it exceed a pre-set tension limit.

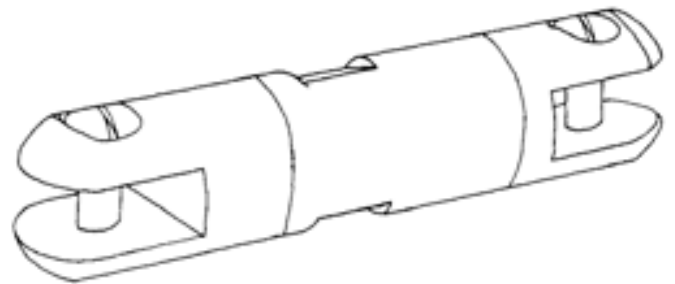

Equipment/Blocks

MULTIPLE CABLE BLOCK

Used to support multiple cables in independent rollers. Multiple cable blocks make a cable positioner unnecessary when lashing multiple cables.

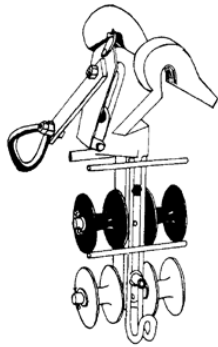

POLE MOUNT CABLE BLOCK

Used to install self-support cable and is attached to the pole hardware to support the cable as it is pulled out. Economy Block Used to support a single cable prior to lashing and, depending on the actual block, may be used when cables are lashed directly to strand or in overlash applications. Appendix 8.8 Equipment/Blocks



SINGLE ROLLER BLOCK

Typically used to support a single cable prior to lashing and may be used when cables are lashed directly to strand or in overlash applications. In new strand situations, single roller blocks may be locked onto the strand. In overlash applications, this block should not be pushed in front of the lasher.

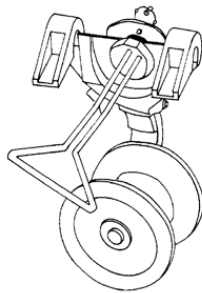

ECONOMY BLOCK

Used to support a single cable prior to lashing and, depending on the actual block, may be used when cables are lashed directly to strand or in overlash applications.

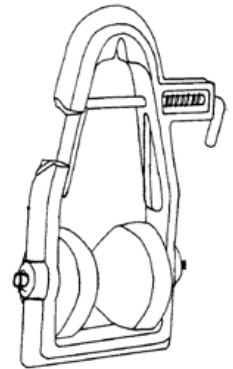

Equipment/Blocks, Chutes and Brackets

90° CORNER BLOCK

Used to route cables through inside or outside corners up to 90°. It minimizes drag on the cable in corners and ensures that the minimum bend radius of the cable is not exceeded. Requires specialized mounting hardware depending on the specific use of the equipment.

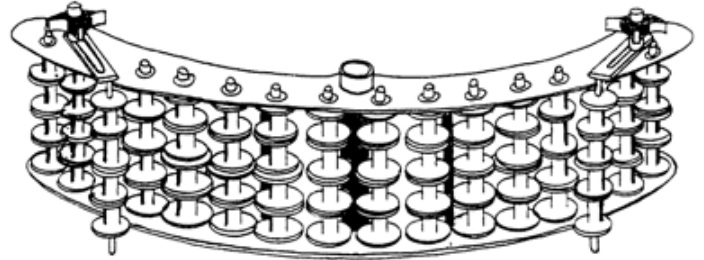

45° CORNER BLOCK

Used to route cables through inside or outside corners up to 45°. It minimizes drag on the cable in corners and ensures that the minimum bend radius of the cable is not exceeded. 45° corner blocks may be used as a set-up chute to guide cables from the cable trailer or a reel stand. Requires specialized mounting hardware depending on the specific use of the equipment.

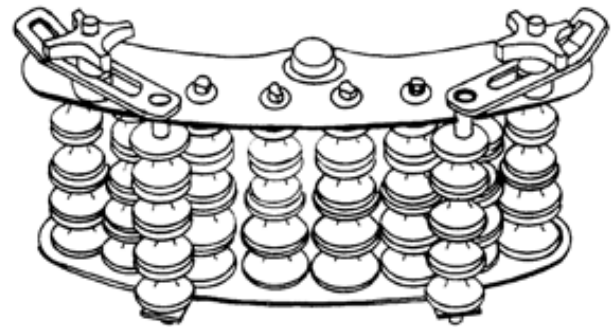

SET-UP CHUTE

A set-up chute is used to guide cables from the cable trailer or reel stand. This equipment requires specialized mounting hardware depending on the specific use of the equipment.

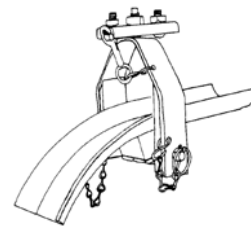

SET-UP BRACKET

This bracket is used to support 45° and 90° corner blocks or set-up chutes at mid-span.

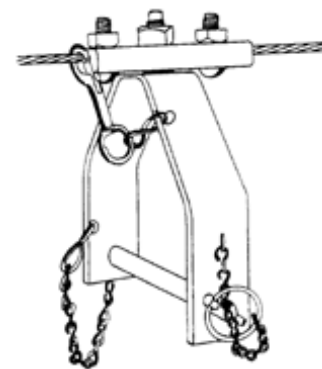

Equipment/Lashers, Pullers, Positioners and Guides

CABLE LASHER

Used to lash cable directly to installed strand or cable bundles. Lashers are somewhat specific to cable and strand size - improper lasher size or adjustment may damage cables.

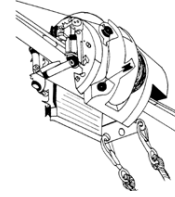

MULTIPLE CABLE PULLER

Allows multiple cables to be pulled into place when lashing cables directly to strand. It's equipped with a strand brake to prevent sagging of cables as the pulling tension is released. Allows pulled cables to independently swivel.

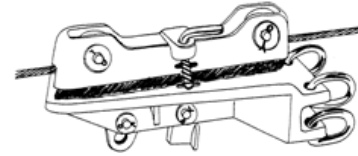

OVERLASH CABLE PULLER

Allows multiple cables to be pulled into place in overlash applications. Allows pulled cables to independently swivel.

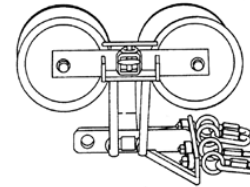

CABLE BLOCK PUSHER (OR SHOTGUN OR SHUTTLE)

Used to push equipment ahead of a pulled lasher.

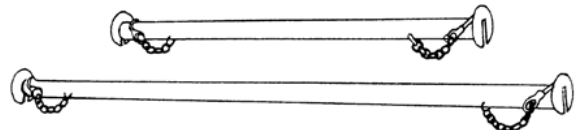

CABLE POSITIONER (OR MAGIC BOX)

Pushed in front of a lasher by a cable block pusher to uniformly position multiple cables that are being lashed.

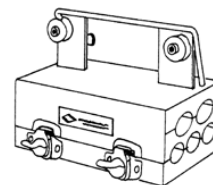

CABLE GUIDE

Used to guide the cable into the lasher in drive-off applications. Can be used for new strand or overlash applications. The guide may be pushed in front of the lasher with a cable block pusher, pulled in front of the lasher or physically attached to the lasher, dependent on the cable guide type.

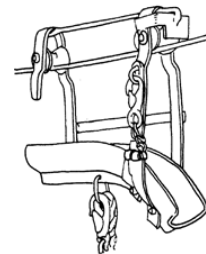

Equipment/Lifting Tools and Brakes

LAY-UP STICK

A fiberglass stick used to lift cable blocks and cables into place utilizing appropriate lay-up stick heads.

CABLE LIFTER (OR LAY-UP STICK HEAD)

Used in conjunction with a lay-up stick to lift cables into place. The lifter ensures that the cables being lifted are not damaged by exceeding minimum bend radii.

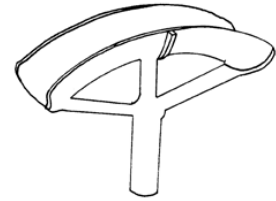

CABLE BLOCK LIFTER

Used in conjunction with a lay-up stick to place assorted cable blocks mid-span.

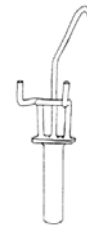

WIRE RAISING TOOL

Used in conjunction with a lay-up stick to lift cable blocks and strand.

STRAND BRAKE

This device is selectively placed at pole hardware locations to prevent dangerous strand sag while strand is being installed. The strand brake allows the strand that is being pulled into place to move in only one direction, which is the direction of the strand pull. Use of strand brakes in conjunction with reel brakes effectively limits the amounts of strand sag between poles during strand installation.

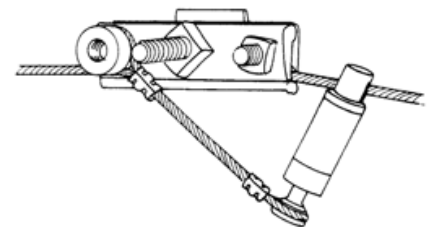

Broadband Resource Center...

your one stop source for cable information

Responsive support and literally years of deployment experience make CommScope a unique build-out partner capable of walking you through broadband logistics each step of the way. To design and maintain high-speed, complex networks you'll need advanced levels of expertise. We realize that getting your technical personnel prepared to ascertain system requirements, understand engineering issues, select and install cable is not an insignificant hurdle. CommScope's Broadband Resource Center exists to help you overcome these obstacles. Our staff has skill sets from the RF, telephony, optical and Internet worlds. We have a menu of services to help you develop technical competence and leadership within your own staff.

Building a reliable, future-proof broadband network requires not only the best technology, but also experience and assistance in deploying that technology. CommScope's Broadband Resource Center stands ready to assist you in your goal – the timely and cost effective deployment of state-of-the-art broadband services.

Our management and technical staff represents over a century of combined experience in coaxial, fiber optic and copper cable engineering and deployment. Members of CommScope's Broadband Resource Center team hold several patents and have been published in a variety of industry publications.



ACTIVE IN YOUR INDUSTRY

Our employees are involved in industry trade groups such as Society of Cable Telecommunications Engineers (SCTE), National Cable Television Association (NCTA), Women In Cable and Telecommunications (WICT), Custom Electronics Design and Installation Association (CEDIA) and Home Builders Association of America (HBA).

Technical Services & Tools

Access to the Broadband Resource Center affords access to the a wide array of services and tools:

ON-SITE CUSTOM TRAINING

Includes courses such as:

- Installation and Splicing
- Construction logistics
- Broadband concepts

CALL CENTER SUPPORT

Get advice such as:

- What products to order
- How to plan for construction
- What to expect along the way

TRAINING COLLATERAL – ALL AVAILABLE FREE, JUST CALL CUSTOMER SERVICE AND REQUEST!

- Comprehensive product catalogs
- Industry standard construction manuals
(Now available in English & Spanish!)
- Training videos available in DVD format
(Now available in English & Spanish!)
- Published articles
- White papers
- Internet web site access to all product
- Specification sheets
- Center conductor sizing guides
- Attenuation slide rules
- Specification assistance / review
- International experience
- Multilingual services available

ENGINEERING SERVICES

- Laboratory analysis
- Standards committee support
- Field trials and troubleshooting support
- Sag and tension analysis



For more information about our Broadband Resource Center or for information on products, please contact us by phone at 1-866-333-3272 or send us an e-mail at brc@commscope.com.

Legal Disclaimer

This manual is provided for guidance purposes only and should not be used or in any way relied upon without consultation with and supervision of experienced construction personnel, engineers or network design specialists. Commscope makes no representations or warranties of any kind, express or implied, including any representation or warranty regarding the quality, content, completeness, suitability, adequacy or accuracy of the data contained herein.

Commscope is under no obligation to issue any upgrades or updates or notify customers/users of this manual that changes have been made to this manual. The user of this manual assumes all risks associated with such use, and commscope hereby disclaims any and all liability for damages of any kind resulting from such use.

CommScope pushes the boundaries of communications technology with game-changing ideas and ground-breaking discoveries that spark profound human achievement.

We collaborate with our customers and partners to design, create and build the world's most advanced networks. It is our passion and commitment to identify the next opportunity and realize a better tomorrow. Discover more at commscope.com

COMMSCOPE®

commscope.com

Visit our website or contact your local CommScope representative for more information.

© 2020 CommScope, Inc. All rights reserved.

Unless otherwise noted, all trademarks identified by ® or ™ are registered trademarks, respectively, of CommScope, Inc. This document is for planning purposes only and is not intended to modify or supplement any specifications or warranties relating to CommScope products or services. CommScope is committed to the highest standards of business integrity and environmental sustainability with a number of CommScope's facilities across the globe certified in accordance with international standards, including ISO 9001, TL 9000, and ISO 14001. Further information regarding CommScope's commitment can be found at www.commscope.com/About-Us/Corporate-Responsibility-and-Sustainability.