

REV	MCO	DWN	DATE
B	8000019185	I AV	20-JAN-17
C	8000023638	JST	01-JUN-17

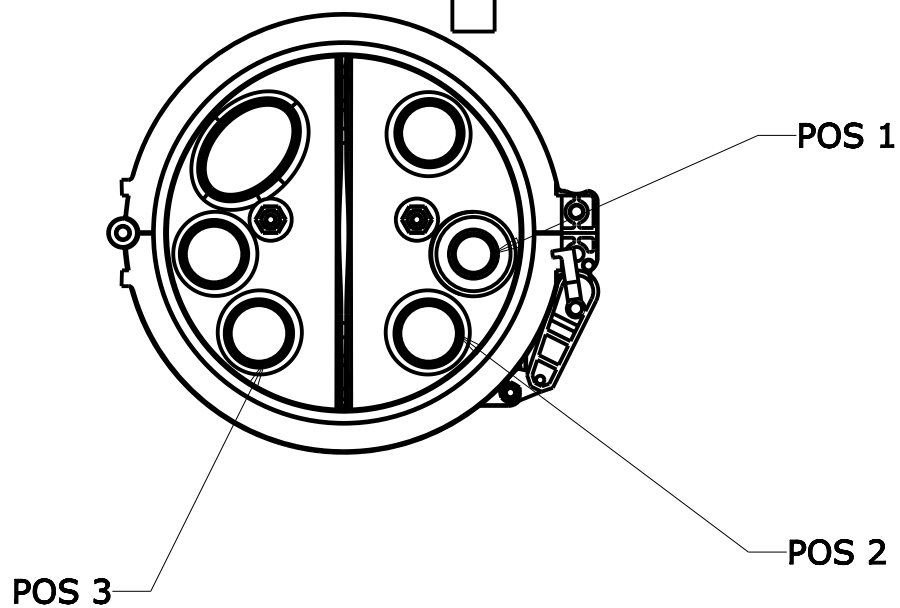
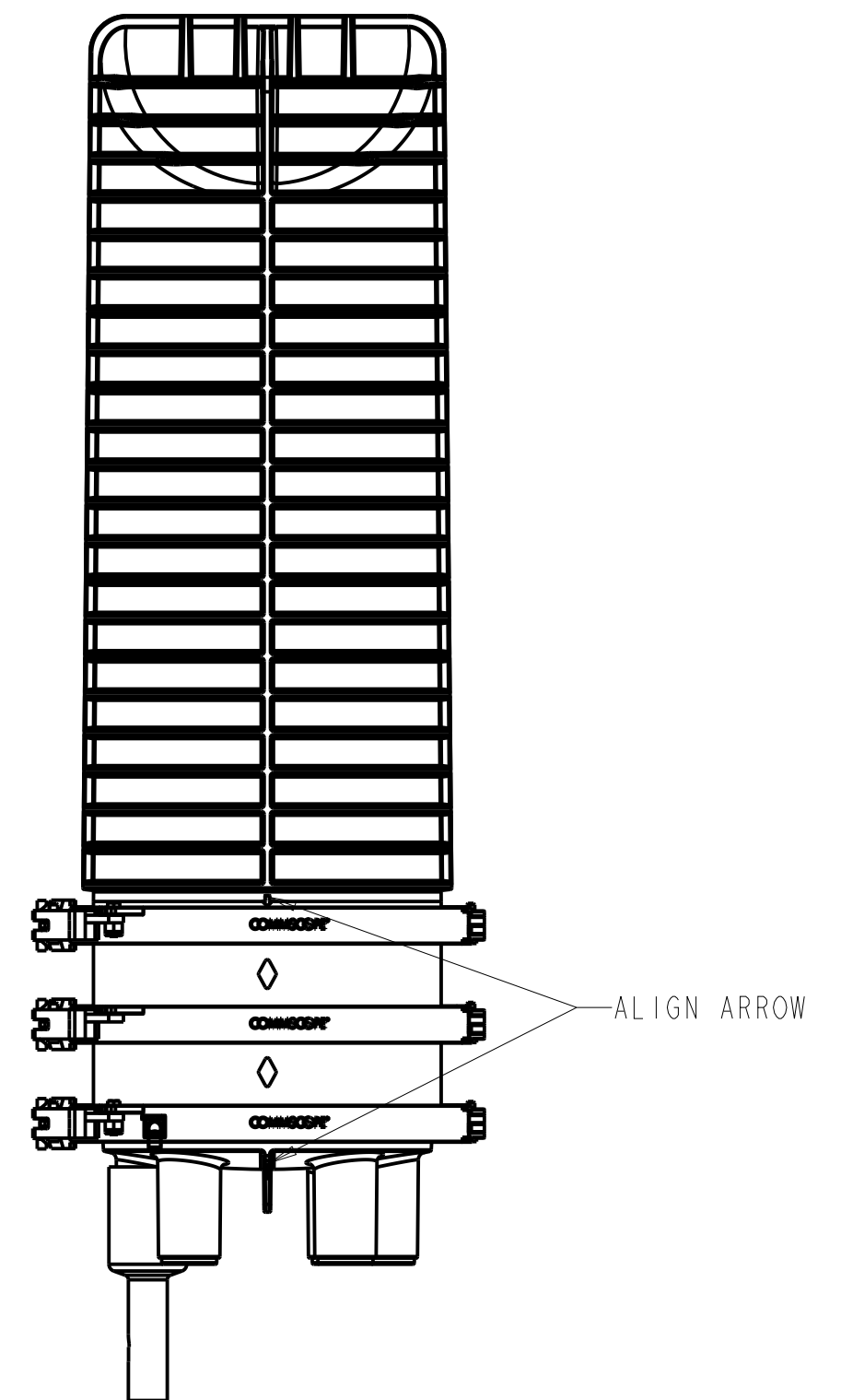
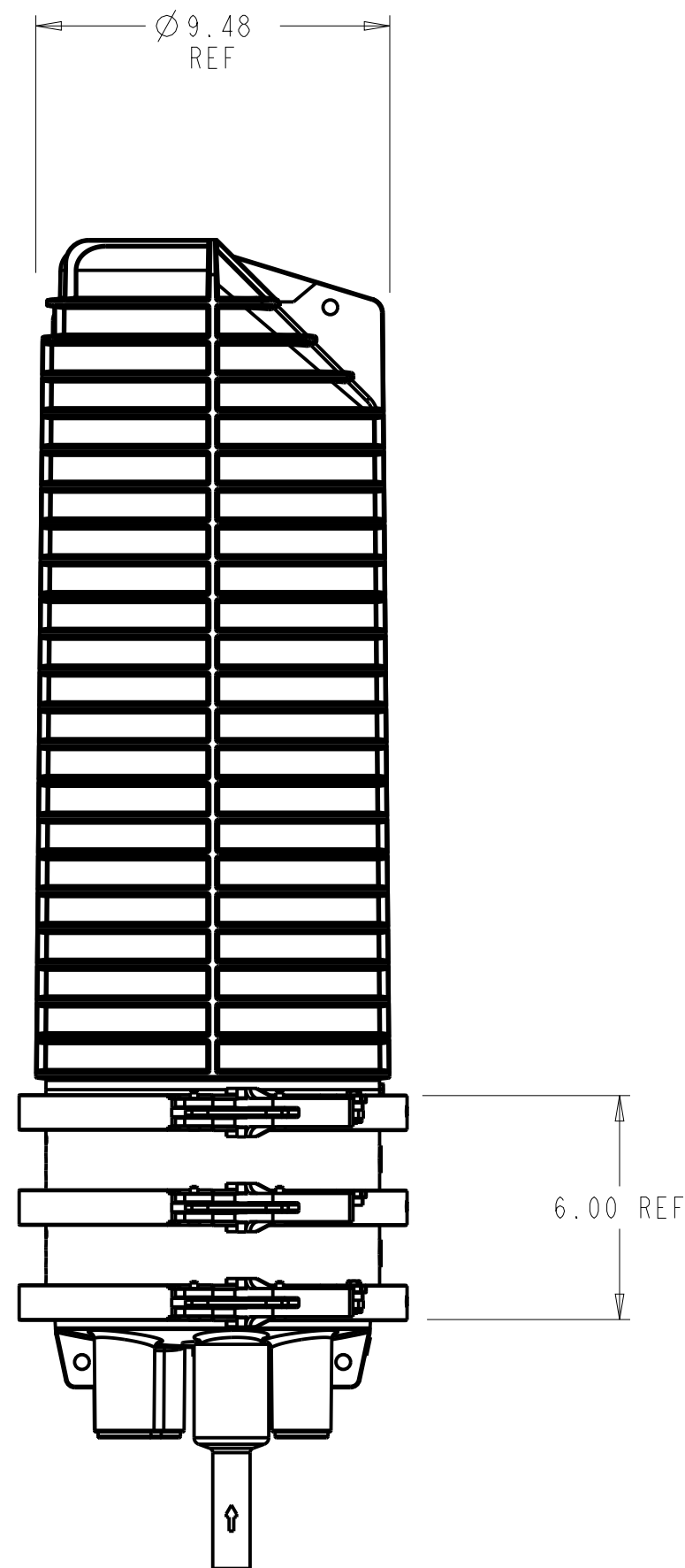
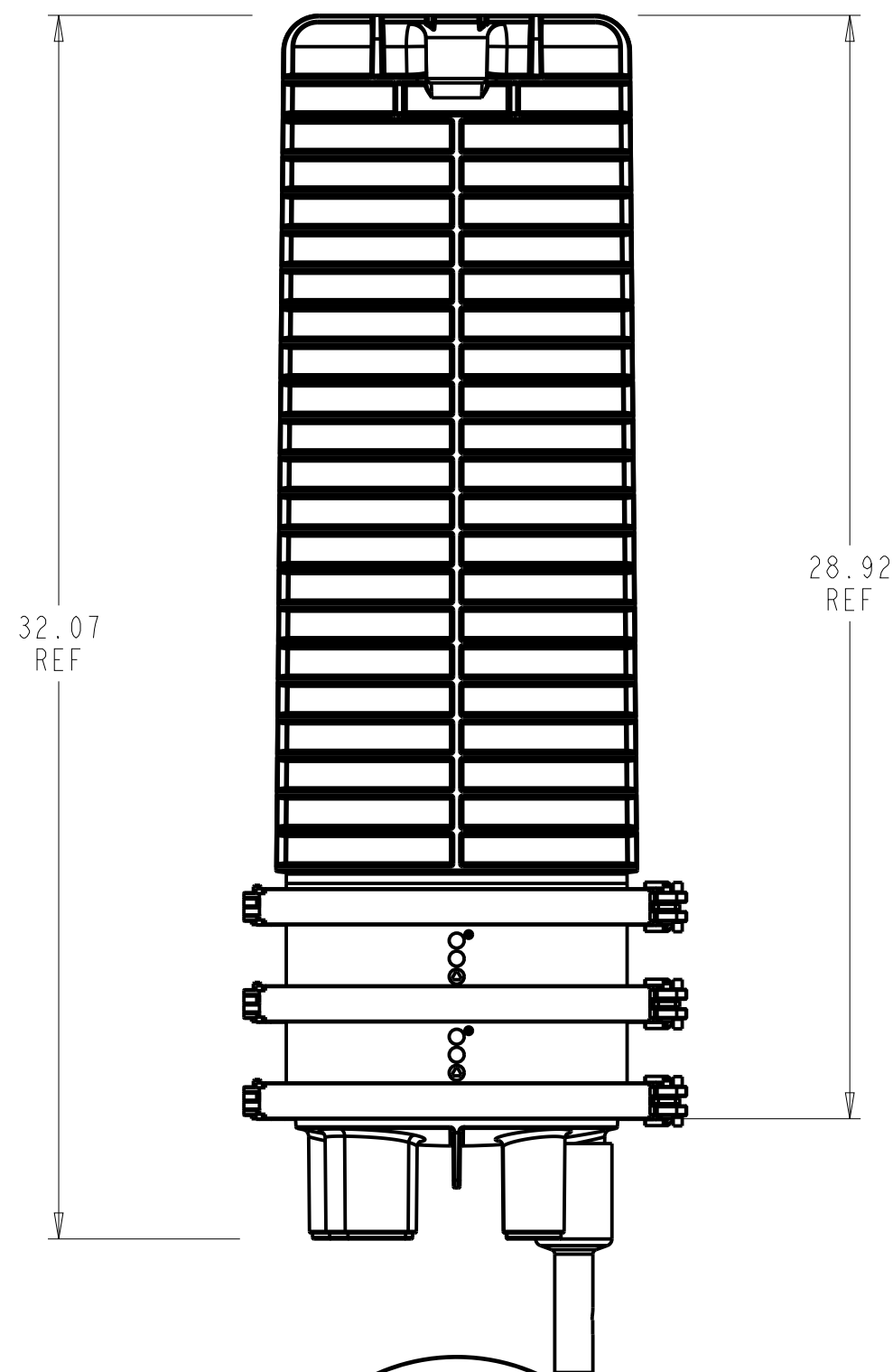
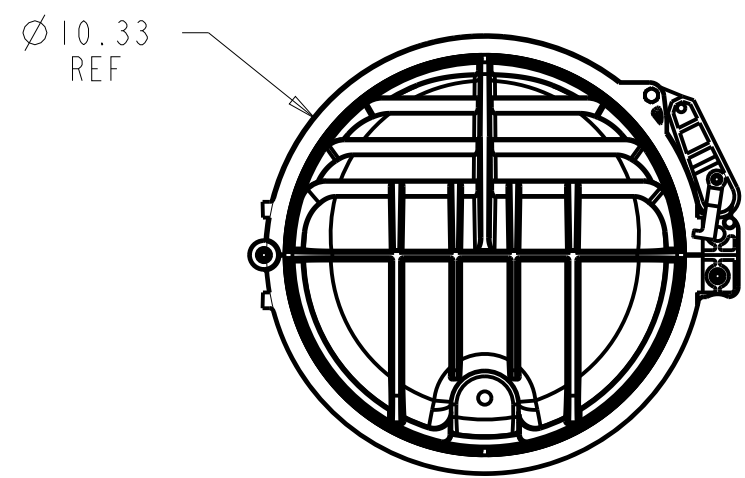

CABLE ASSIGNMENTS					
CABLES QTY	DISTRIBUTION CABLE POSITION			FEEDER CABLE POSITION	
1	CABLE 1: POS 1				
2	CABLE 1	POS 1	CABLE 2	POS 2	
3	CABLE 1	POS 1	CABLE 2	POS 2	CABLE 3 POS 3

COMMSCOPE, INC.

© 2016 COMMSCOPE, INC. CONFIDENTIAL
 NOTICE: THESE DRAWINGS AND SPECIFICATIONS
 ARE THE PROPRIETARY PROPERTY OF
 COMMSCOPE, INC. AND MAY BE USED ONLY FOR THE
 SPECIFIC PURPOSE AUTHORIZED IN WRITING BY
 COMMSCOPE, INC.

TITLE INSTALLATION DRW
 FDH4000 288F

ALL DIMS AND TOLERANCES .XX:±N/A
 ARE INCHES UNLESS .XXX:±N/A
 OTHERWISE SPECIFIED ANGULAR:±N/A

DRAWING NUMBER 300100112286

DO NOT SCALE DRAWING

ENGR: JORGE SOTO
 DWN: JORGE SOTO

SHT. 1 OF 4

DIMENSIONS IN INCHES
 THIRD ANGLE PROJECTION

A

B

C

D

SHOWN WITHOUT DOME FOR CLARITY

DISTRIBUTION, FEEDER AND SPLITTER SLOTS ARE RECONFIGURABLE

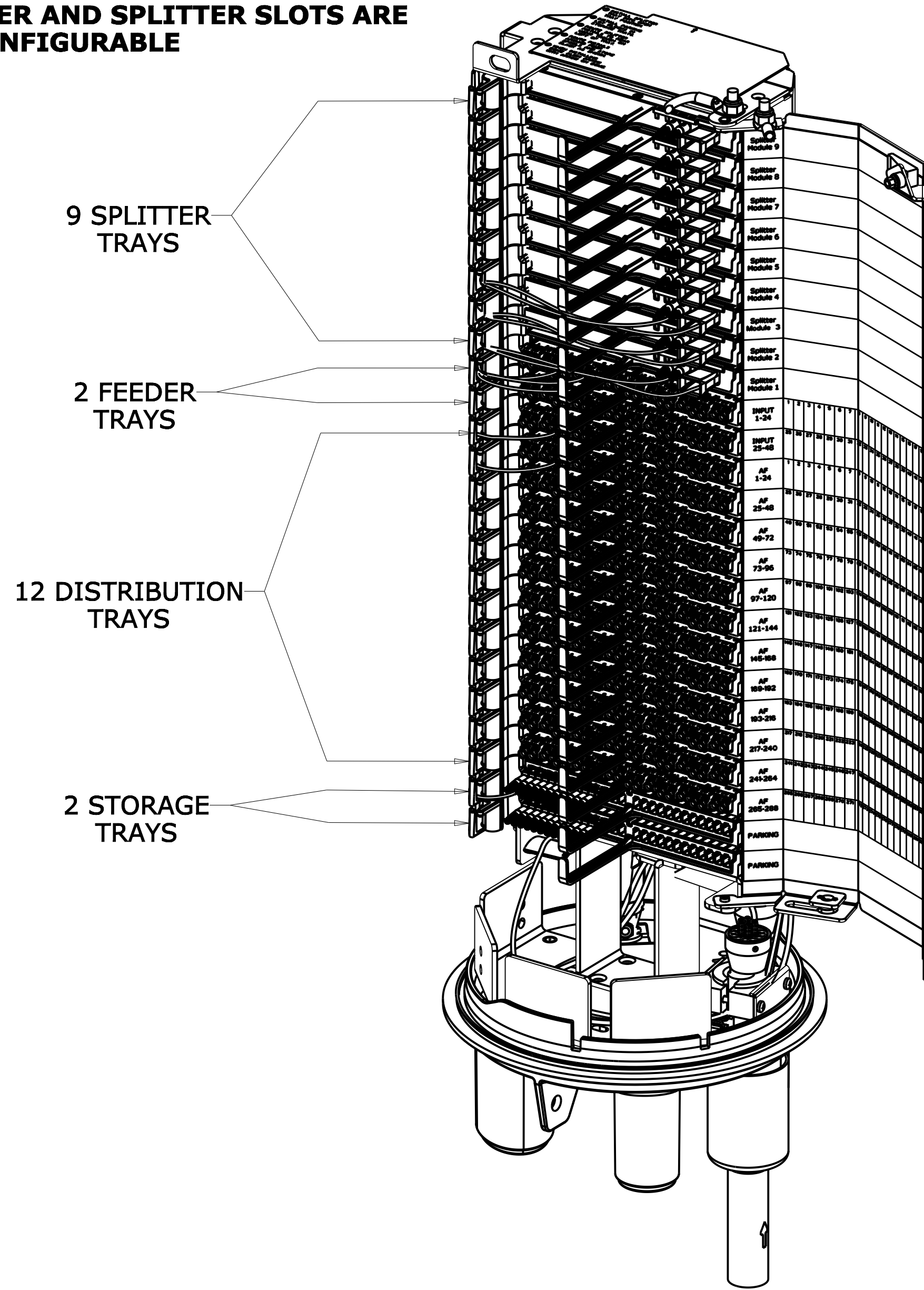

ISO FRONT VIEW

COMMSCOPE, INC.

<small>© 2016 COMMSCOPE, INC. CONFIDENTIAL NOTICE: THESE DRAWINGS AND SPECIFICATIONS ARE THE PROPRIETARY PROPERTY OF COMMSCOPE, INC. AND MAY BE USED ONLY FOR THE SPECIFIC PURPOSE AUTHORIZED IN WRITING BY COMMSCOPE, INC.</small>		TITLE INSTALLATION DRW FDH4000 288F	
<small>ALL DIMS AND TOLERANCES ARE INCHES UNLESS OTHERWISE SPECIFIED</small>	<small>.XX:±N/A .XXX:±N/A ANGULAR:±N/A</small>	C SIZE	DRAWING NUMBER 300100112286
DO NOT SCALE DRAWING		ENGR: JORGE SOTO DWN: JORGE SOTO	SHT. 2 OF 4

DIMENSIONS IN INCHES
THIRD ANGLE PROJECTION

SHOWN WITHOUT DOME FOR CLARITY

ISO BACK VIEW

ISO FRONT VIEW

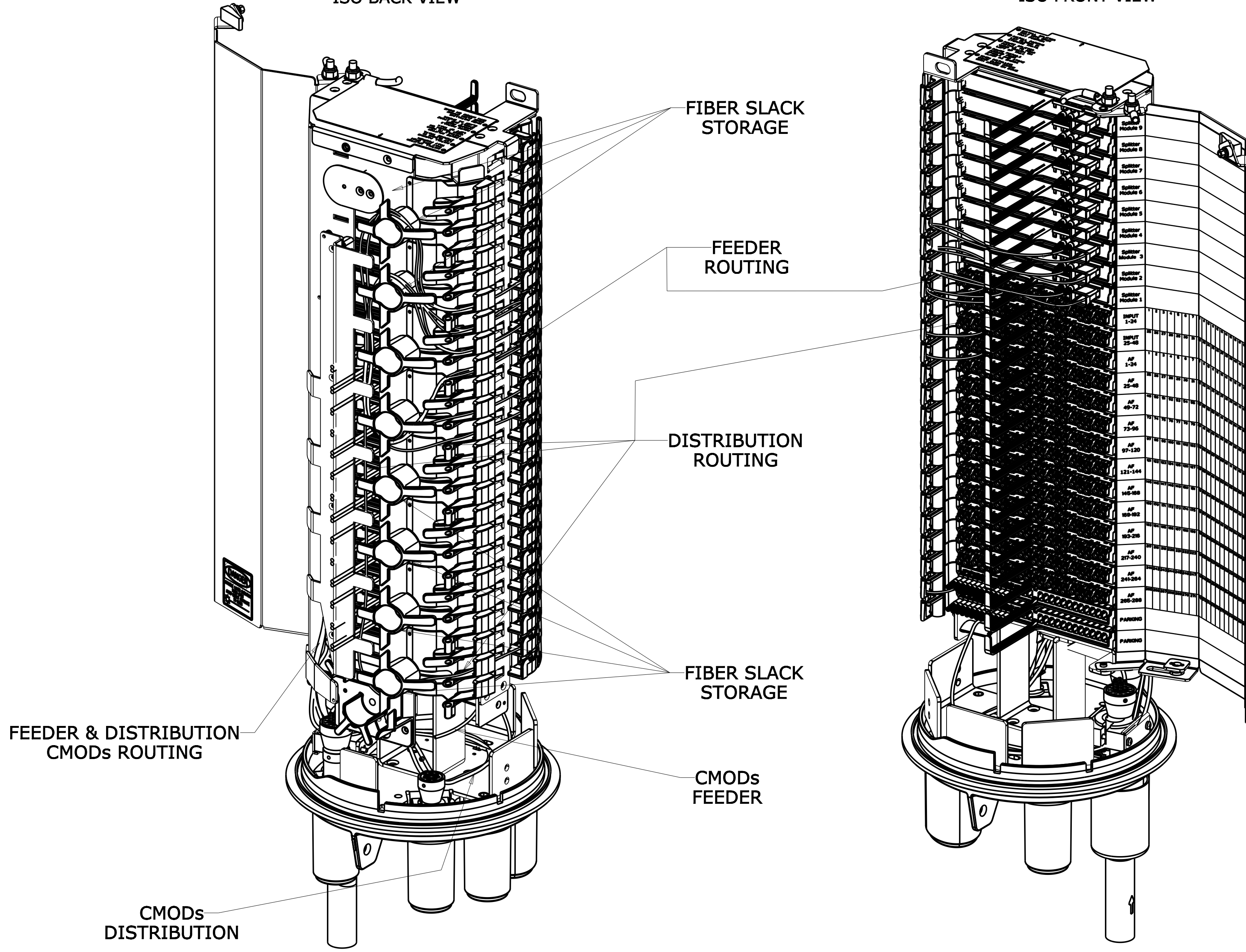

<small>© 2016 COMMSCOPE, INC. CONFIDENTIAL NOTICE: THESE DRAWINGS AND SPECIFICATIONS ARE THE PROPRIETARY PROPERTY OF COMMSCOPE, INC. AND MAY BE USED ONLY FOR THE SPECIFIC PURPOSE AUTHORIZED IN WRITING BY COMMSCOPE, INC.</small>		TITLE INSTALLATION DRW FDH4000 288F	
<small>ALL DIMS AND TOLERANCES .XX:±N/A ARE INCHES UNLESS .XXX:±N/A OTHERWISE SPECIFIED ANGULAR:±N/A</small>		C SIZE DRAWING NUMBER 300100112286	C REV
DO NOT SCALE DRAWING		ENGR: JORGE SOTO DWN: JORGE SOTO	SHT. 3 OF 4

COMMSCOPE, INC.

DIMENSIONS IN INCHES
THIRD ANGLE PROJECTION

SHOWN WITHOUT DOME FOR CLARITY
ROUTING DETAIL

**DISTRIBUTION
ROUTING**

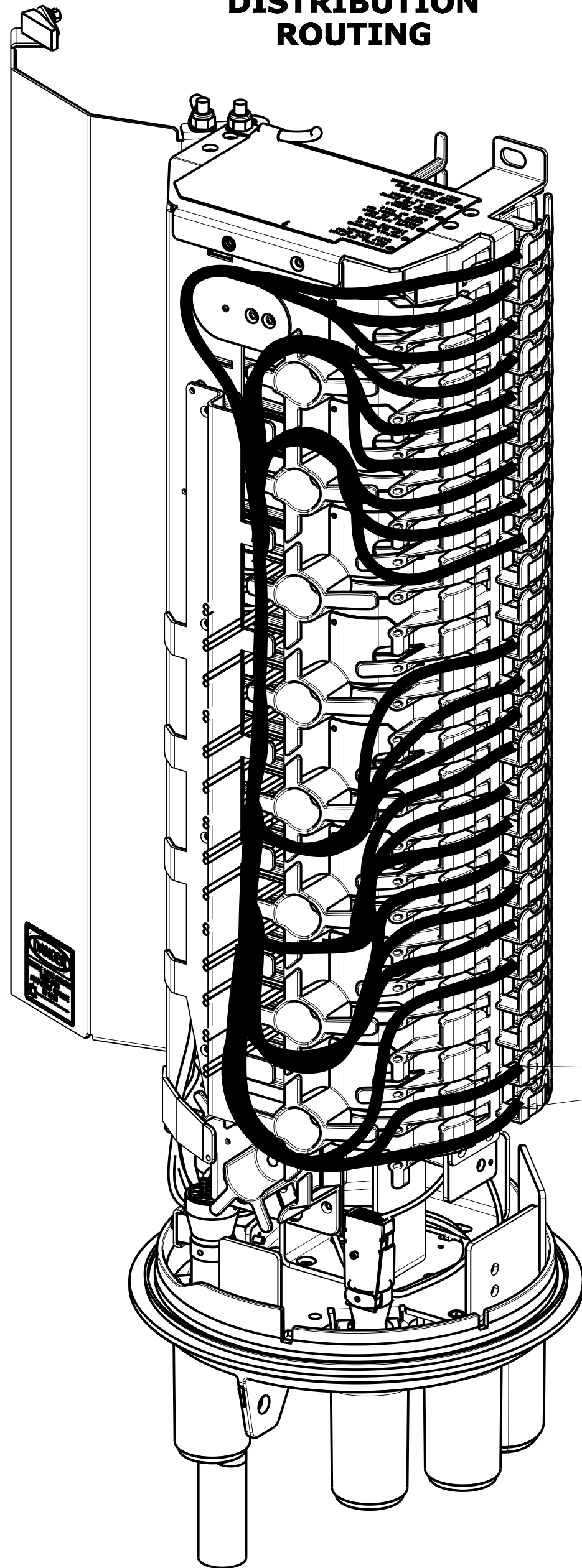

PARKING LOTS

**FEEDER
ROUTING**

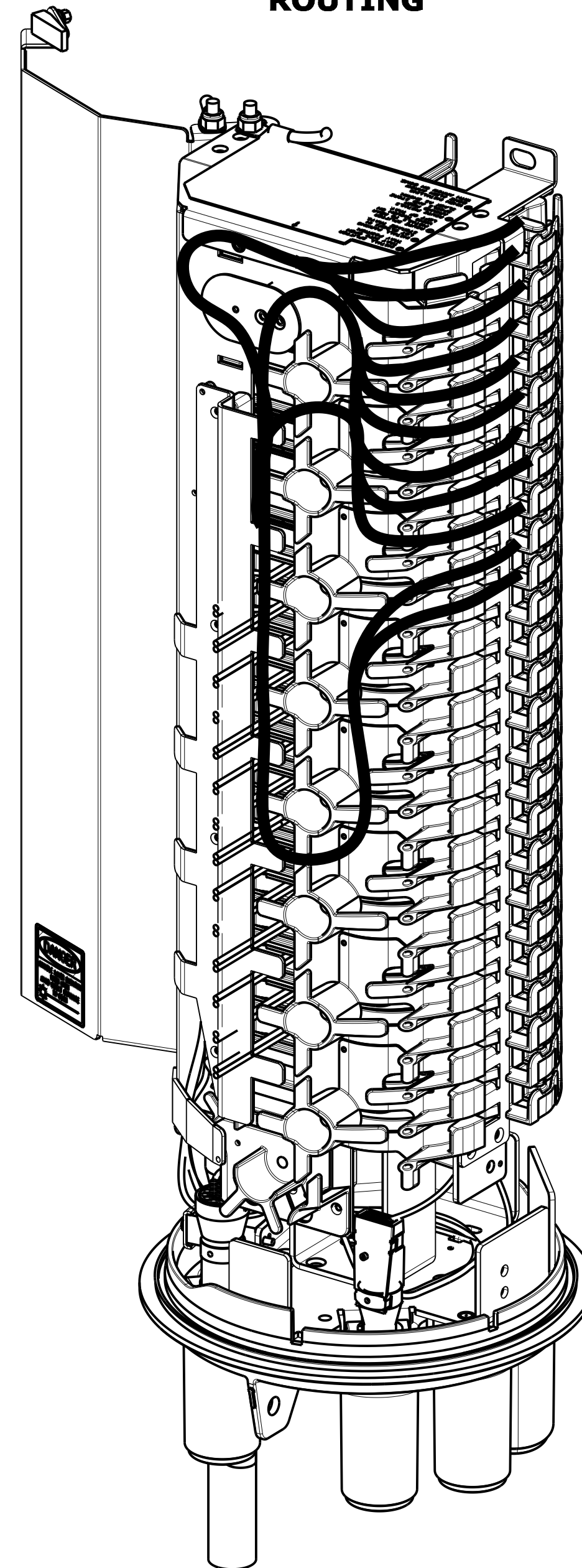

COMMSCOPE, INC.

© 2016 COMMSCOPE, INC. CONFIDENTIAL
NOTICE: THESE DRAWINGS AND SPECIFICATIONS
ARE THE PROPRIETARY PROPERTY OF
COMMSCOPE, INC. AND MAY BE USED ONLY FOR THE
SPECIFIC PURPOSE AUTHORIZED IN WRITING BY
COMMSCOPE, INC.

ALL DIMS AND TOLERANCES .XX:±N/A
ARE INCHES UNLESS .XXX:±N/A
OTHERWISE SPECIFIED ANGULAR:±N/A

DO NOT SCALE DRAWING

ENGR: JORGE SOTO
DWN: JORGE SOTO

TITLE
INSTALLATION DRW
FDH4000 288F

DRAWING NUMBER
300100112286

SHT. 4 OF 4

DIMENSIONS IN INCHES
THIRD ANGLE PROJECTION