

Installation Guidelines – HELIAX® 12 RRU Assembly Solution: Pendant Configuration

Related Support and Learning Opportunities Offered by the CommScope Infrastructure Academy

The insights and expertise contained in this manual represent just one small part of CommScope's global learning initiative. Few industries are evolving as quickly as wireless communications. Every technological innovation impacts what happens in the field. Our customers look to the CommScope Infrastructure Academy to make sure their technicians and installers are well trained, well-prepared, and well-educated to take advantage of opportunities as they evolve. To access a course, go to www.commscope.com/training/coursecatalog.php, course #6107

Section 1: HELIAX® Pendant Connect / Accessories	02
Section 2: General Specifications: Trunk	03
Section 3: Hoisting Considerations	04
Section 4: Mounting	07
Section 5: General Specifications: Junpers	08
Section 6: HQLC Installation	11
Section 8: Fiber Mapping	12
Section 9: FE-16148-OVP-B12 Junction Box Wiring Diagram	13
Section 10: Breakout Procedure / DLC Connection Considerations	15
Section 11: All-in-One Cleaner / Inspecting	16
Section 12: Excess Cable Management	17
Section 13: Jacketing Removal Procedure for Universal Grounding	19
Section 14: Installation Check List	20

Section 1: Pendant Connect

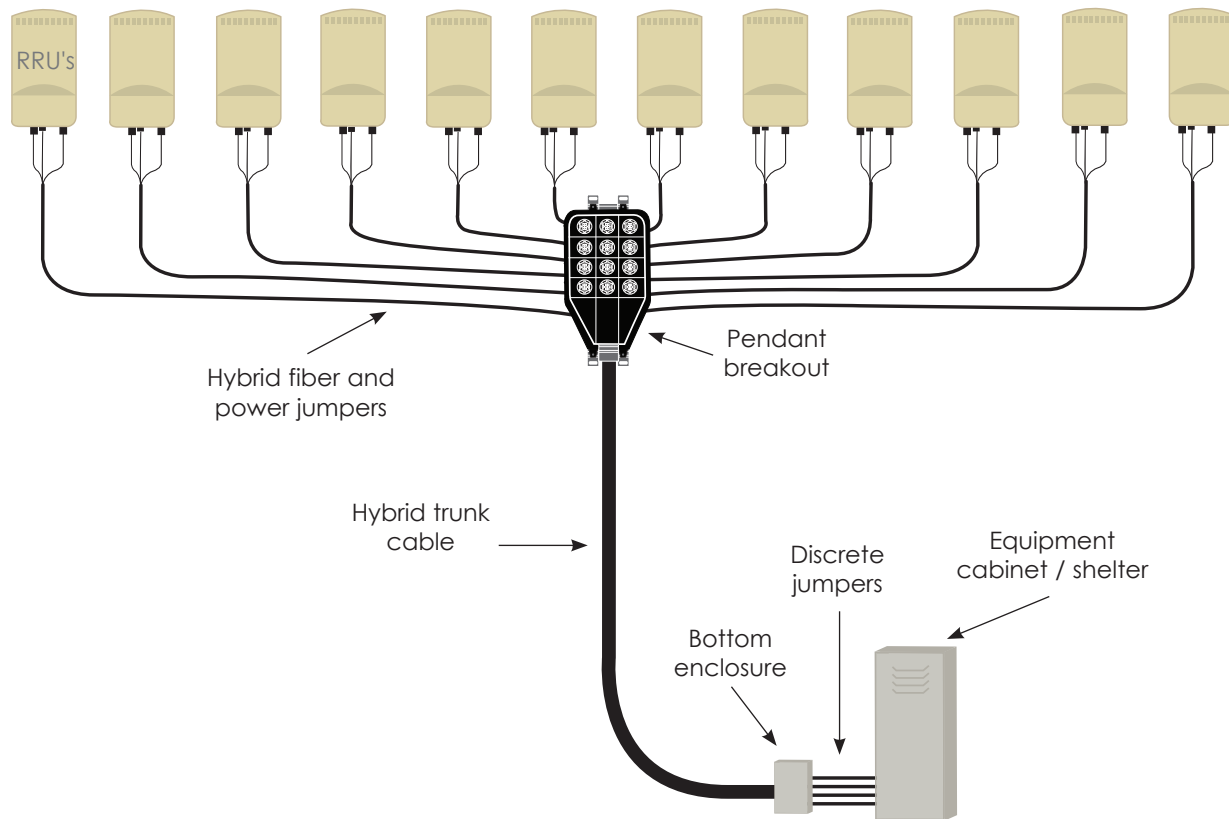

Accessories

Bottom Enclosure

PART NUMBER	DESCRIPTION
FE-16148-OVP-B12	Fiber and power cable connection enclosure. Weatherproof to IP67

Other

DESCRIPTION	CABLE PART NUMBER		
	FD21206	FD21204	Hybrid Jumper Assemblies
Hoisting Grip	29961-C	29961-C	N/A
Hanger	SSH-XL	SSH-XL	SSH-M
Angle Adapter	UA-3	UA-3	UA-3
3-way Standoff	SA-38	SA-38	SA-38
Round member adapter, 2 to 3 inch	31670-2	31670-2	31670-2
Round member adapter, 3 to 4 inch	31670-3	31670-3	31670-3
Round member adapter, 4 to 5 inch	31670-4	31670-4	31670-4
Universal grounding kit	UG12158-15B4-T	UG12158-15B4-T	UG12158-15B4-T

Section 2: General Specifications

Cable Type	FD21206-48SRC-XXX	FD21204-48SRC-XXX
Center Conductor Gauge	6 AWG (up to 225 ft)	4 AWG (250 - 450 ft)
Conductors, quantity	12	12
Total Fiber Quantity	48	48
Fiber Type	G.657.A2/B2	G.657.A2/B2
Specifications		
Cable Weight	2544.0 kg/km 1710.0 lb/kft	3,576 kg/km 2403 lb/kft
Diameter Over Jacket	39.38 mm 1.55 in	44.70 mm 1.76 in
Breakout Length, Fiber, end 2	775 mm 31 in	775 mm 31 in
	826 mm 33 in	826 mm 33 in
Breakout Length, Power, end 2	610 mm 24 in	610 mm 24 in
Minimum Bend Radius	472.44 mm 18.6 in	360.7 mm 14.2 in

PART NUMBER	DESCRIPTION
FD21206-48SRC-XXX	6AWG or 4AWG 12 RRU Hybrid Trunk Cables End 1: Pendant breakout enclosure with 12 HQLC Senko IP25 Plug connection interface.
FD21204-48SRC-XXX	End 2: 12-6 WG or 12-4AWG DC conductors blunt-cut, 48 single mode fibers (24 pairs) terminated DLC

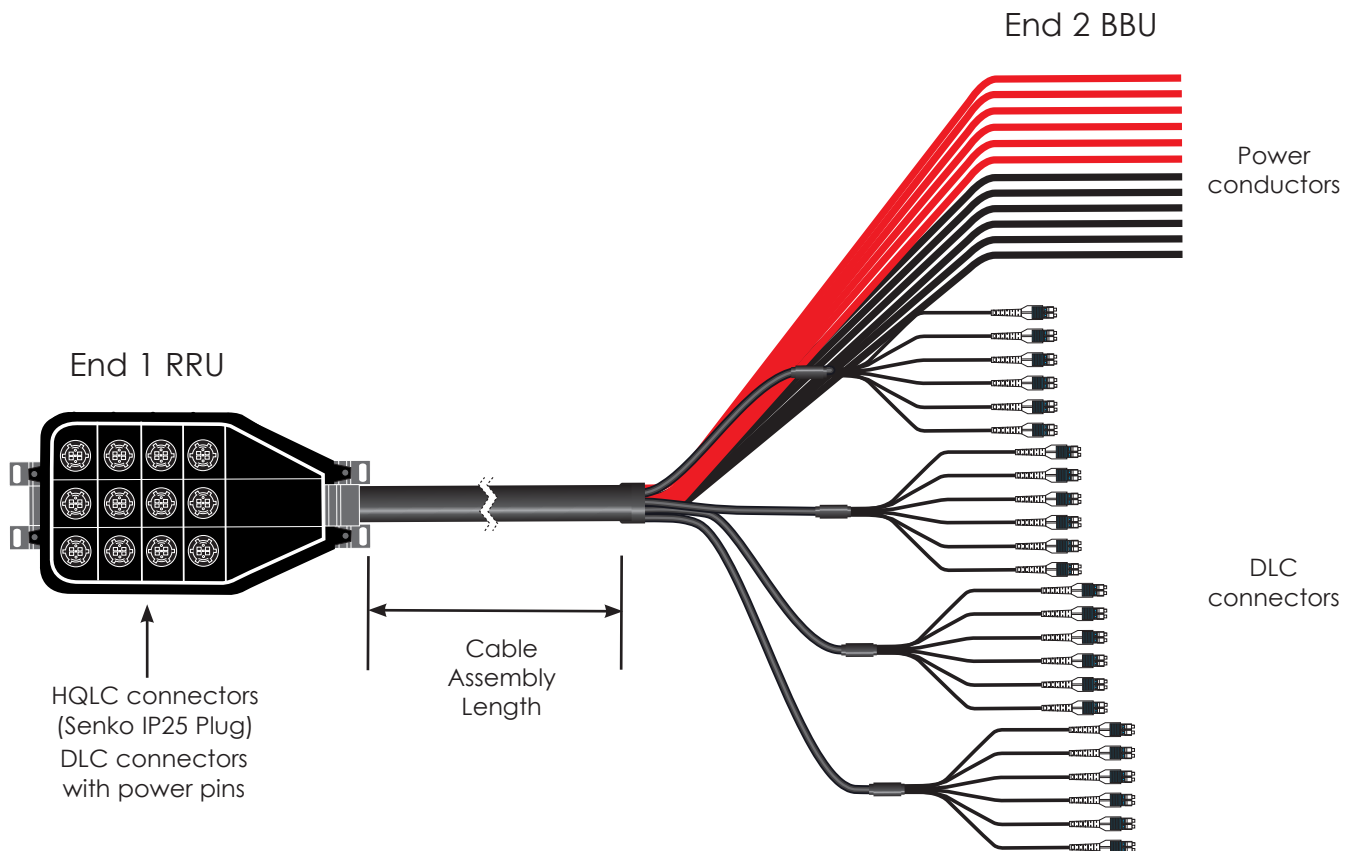

Section 3: Hoisting Considerations

- In general this cable will handle similarly to coaxial cable, and similar installation techniques apply. All cables are individually serialized, be sure to write down the cable serial number for future reference.
- Be sure that the Pendant is not damaged by attachment of a hoisting grip or during the hoisting process.
- During hoisting ensure that there is a free path and that the cable.
- Installation temperature range is -30 °C to +70 °C (-22 °F to +158 °F).
- Maximum cable tensile load can be found on-line in our eCatalog section at www.commscope.com.
- **CommScope Lace-Up Hoisting Grip 29961-C for FD21206 and FD21204 installation.**
- **Hoisting Grip should be anchored to the support structure after the hangers are installed.**

 Hybrid Fiber Cables weigh more than traditional coaxial cables. Be sure to follow proper hoisting and attachment procedures.

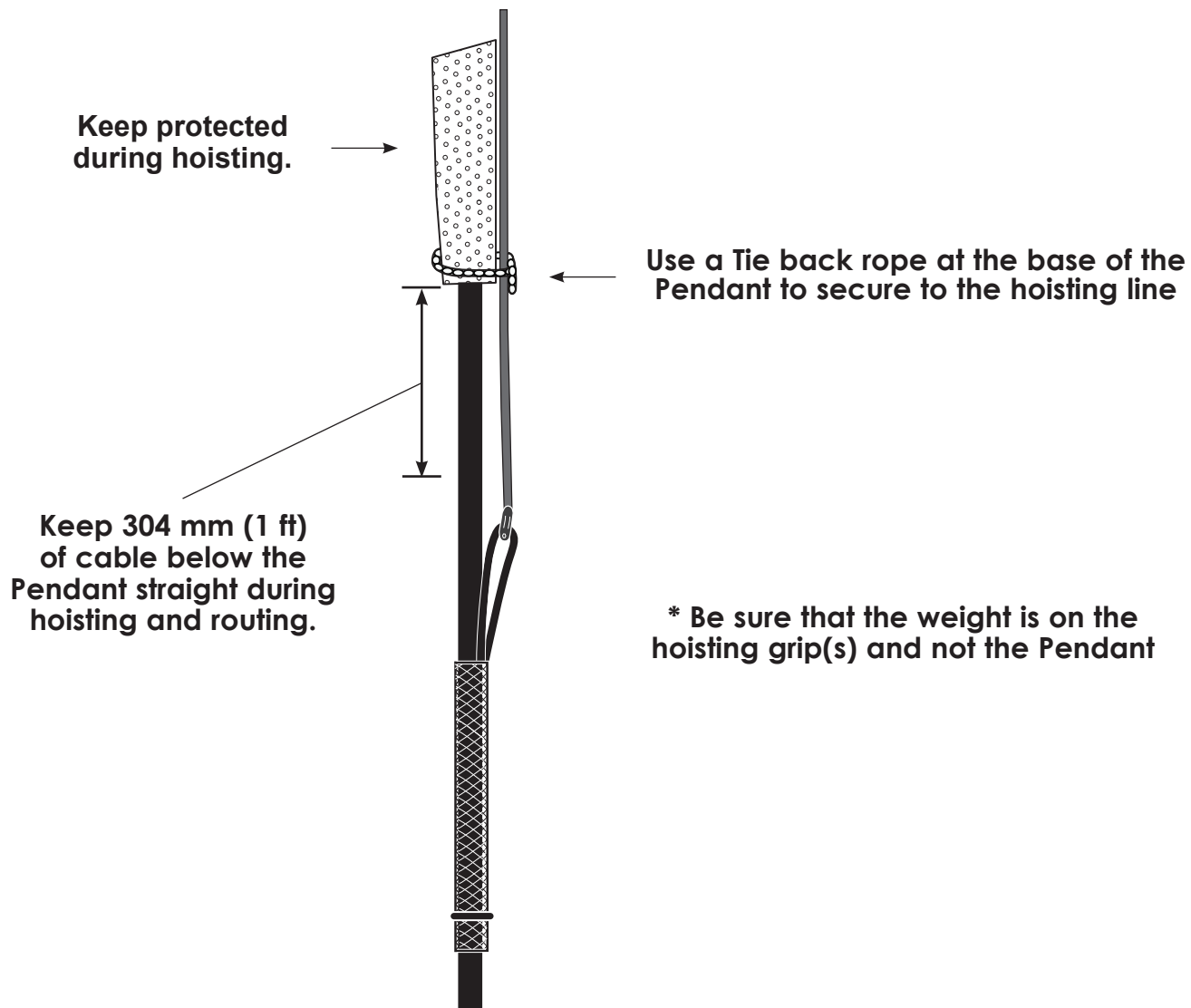

Hoisting Considerations

* If the structure does not allow the Pendant to fit through access ports due to space limitations skip to page #6

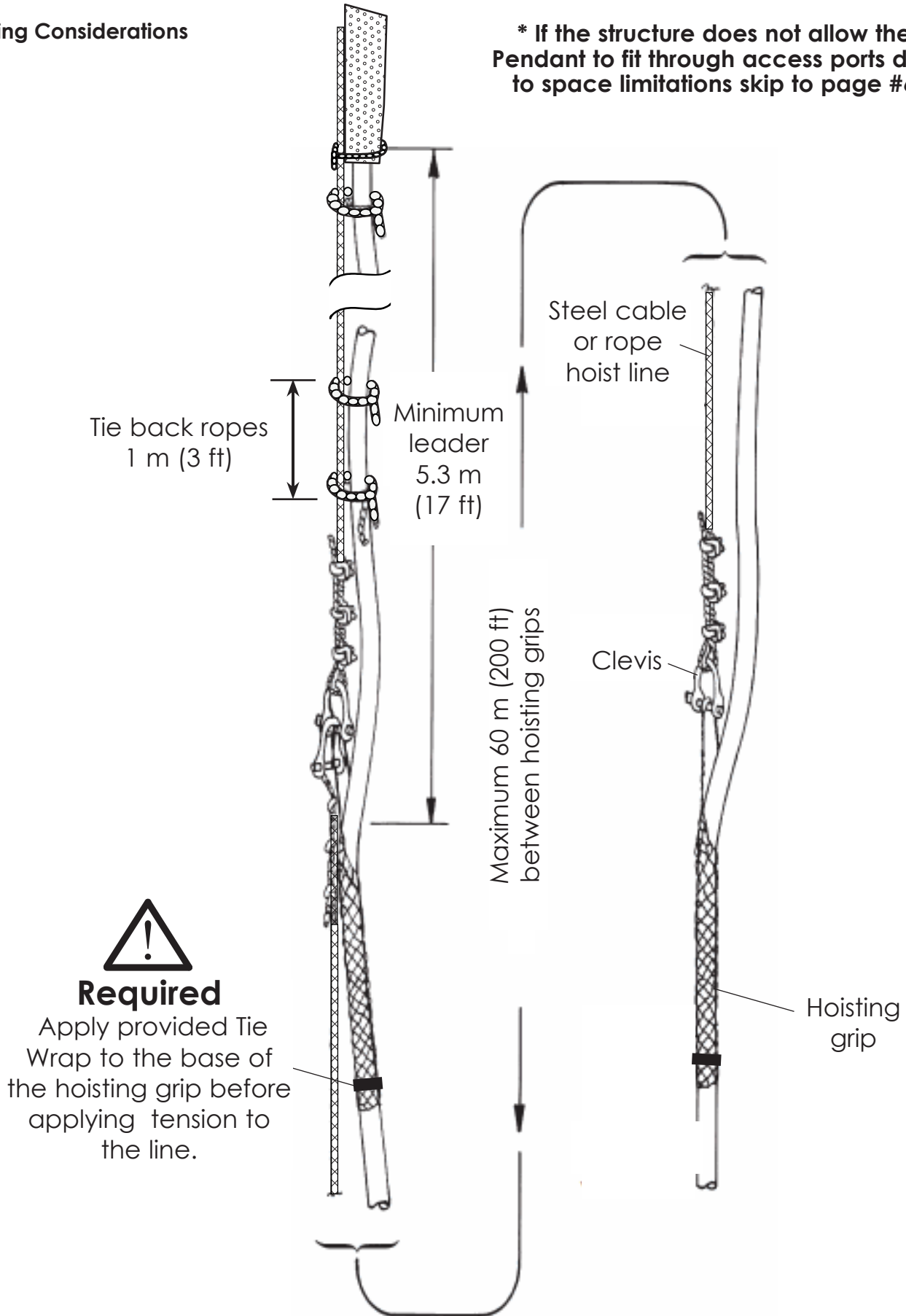

Required
Apply provided Tie Wrap to the base of the hoisting grip before applying tension to the line.

Hoisting Considerations

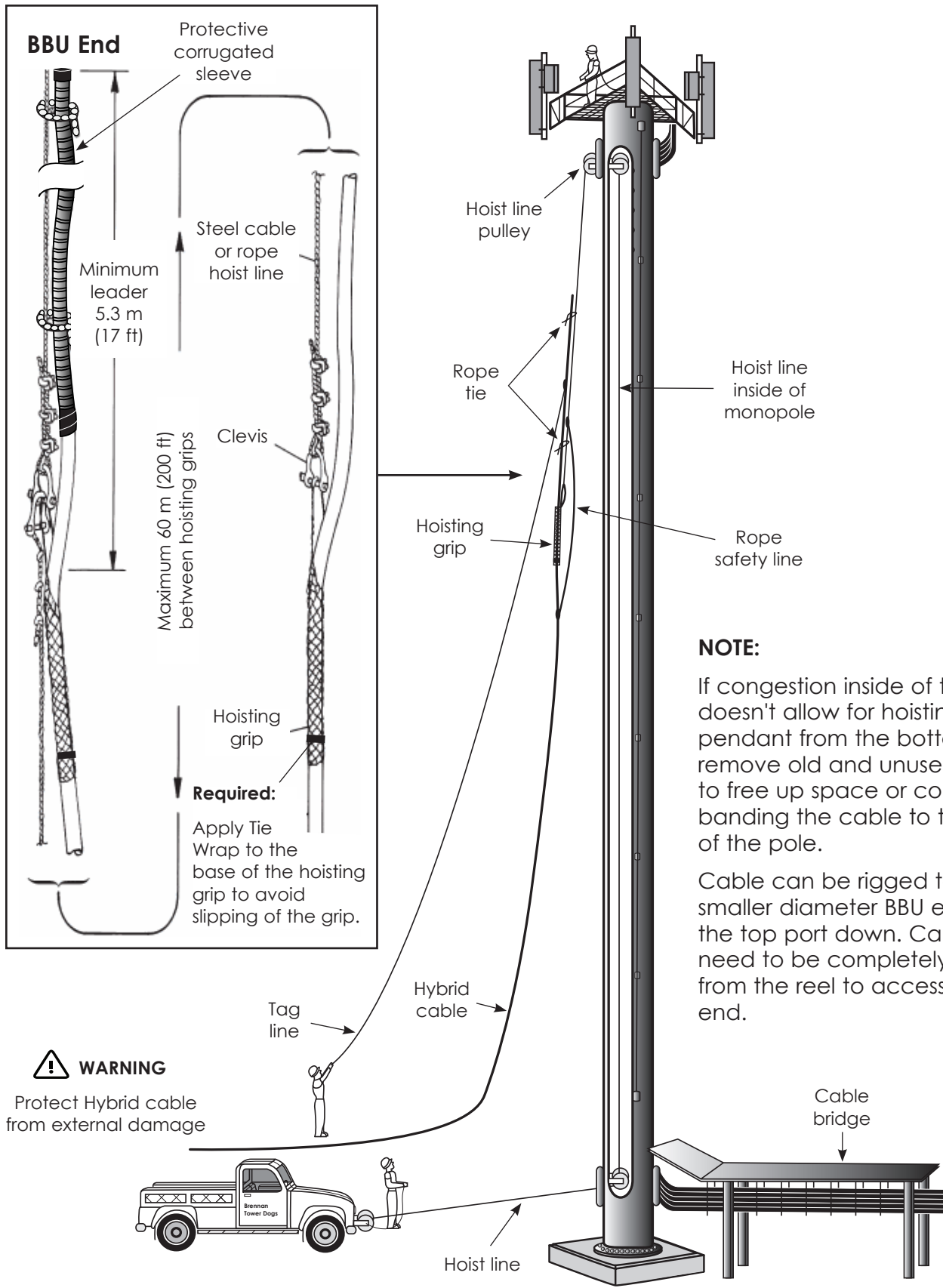

NOTE:
 If congestion inside of the pole doesn't allow for hoisting the pendant from the bottom port remove old and unused coax to free up space or consider banding the cable to the outside of the pole.
 Cable can be rigged to pull the smaller diameter BBU end from the top port down. Cable will need to be completely uncoiled from the reel to access the BBU end.

WARNING
 Protect Hybrid cable from external damage

Section 4: Mounting

Pendant allows mounting on poles, H-frames, walls, and other common structures on towers, buildings, etc. Contractor provides appropriate hardware.

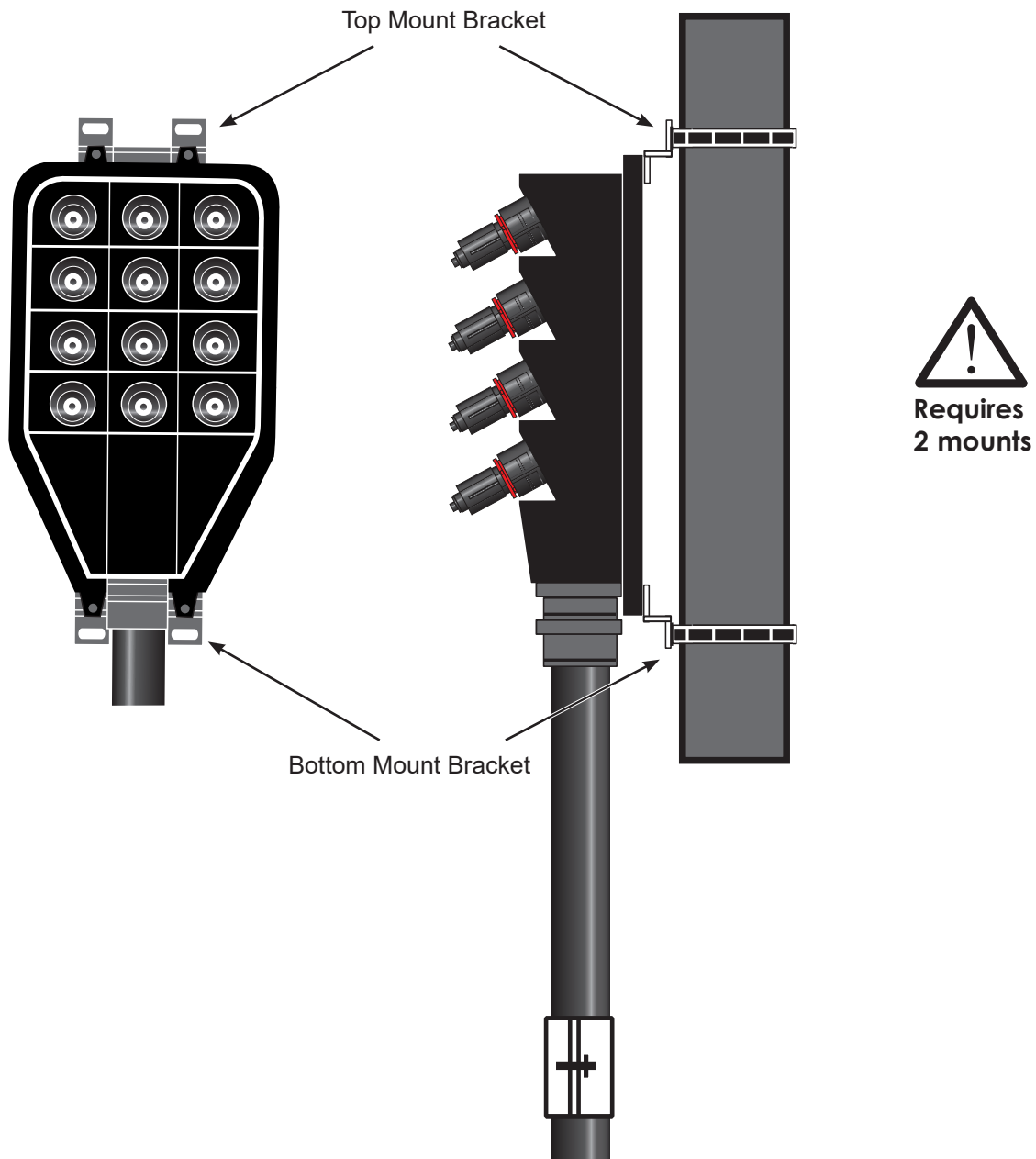

Section 5: General Specifications Jumpers

- The terminated fiber ends however are fragile and must be protected during installation. Leave the packaging around the fiber ends in place until ready to make final connection of the jumper at the RRU or BBU.
- DO NOT BEND THE FIBER ENDS TIGHTER THAN 30 mm (1.2 in) BEND RADIUS ELSE THERE IS A RISK OF BREAKING THE GLASS FIBERS.
- Attach the main cable securely to the structure or equipment using mount to prevent strain on connections from movement in wind or snow/ice conditions.
- HQLC outdoor connector is a 1/4 turn, tighten until the shell hits a positive stop.
- Installation temperature range is -30 °C to 70 °C (-22 °F to 158 °F).
- Red conductor is -48V and Black is the Return.

General Specifications

Cable Type	HFT410-4SNOK2-xx	HFT410-4SNOK4-xx	HFT410-4SNOK5-xx
Total Fiber Quantity	4	4	4
Conductor AWG quantity	10 4	10 4	10 4
Fiber Type	G.657.A2	G.657.A2	G.657.A2
Specifications			
Cable Weight	456.1 kg/km 306.5 lb/kft	456.1 kg/km 306.5 lb/kft	456.1 kg/km 306.5 lb/kft
Breakout Length Fiber, end 1	815 mm 32 in	750 mm 29.5 in	815 mm 32 in
Breakout Length Power, end 1	895 mm 35 in	775 mm 30.5 in	457 mm 18 in
Breakout Length Fiber, end 2	609 mm 24 in	609 mm 24 in	609 mm 24 in
Breakout Length Power, end 2	609 mm 24 in	609 mm 24 in	609 mm 24 in
Diameter Over Jacket	18.31 mm 0.72 in	18.31 mm 0.72 in	18.31 mm 0.72 in
Minimum Bend Radius	221.0 mm 8.7 in	221.0 mm 8.7 in	221.0 mm 8.7 in

General Specifications (cont.)

Cable Type	HFT206-4SNOK6-xx	HFT206-6SB41-xx	HFT206-8SB41-xx
Total Fiber Quantity	4	6	8
Conductor AWG quantity	6 2	6 2	6 2
Fiber Type	G.657.A2	G.657.A2 /B2	G.657.A2/B2
Specifications			
Cable Weight	456.1 kg/km 306.5 lb/kft	726.2 kg/km 488 lb/kft	726.2 kg/km 488 lb/kft
Breakout Length Fiber, end 1	787 mm 31 in	864 mm 34 in	864 mm 34 in
Breakout Length Power, end 1	762 mm 30 in	800 mm 31.5 in	800 mm 31.5 in
Breakout Length Fiber, end 2	609 mm 24 in	609 mm 24 in	609 mm 24 in
Breakout Length Power, end 2	609 mm 24 in	609 mm 24 in	609 mm 24 in
Diameter Over Jacket	18.31 mm 0.72 in	24.4 mm 0.96 in	25.8 mm 1.0 in
Minimum Bend Radius	221.0 mm 8.7 in	292.1 mm 11.5 in	309.8 mm 12.2 in

General Specifications (cont.)

Cable Type	DFJ-6S010-xx DFJ-12S010-xx	DFJ-6S025-xx DFJ-12S025-xx
Total Fiber Quantity	6 or 12	6 or 12
Fiber Type	G.657.A2	G.657.A2
Specifications		
Cable Weight	69 kg/km 46 lb/kft	69 kg/km 46 lb/kft
Breakout Length Fiber, end 1	762 mm 30 in	762 mm 30 in
Breakout Length Fiber, end 2	1067 mm 42 in	1067 mm 42 in
Diameter Over Jacket	8 mm 0.31 in	8 mm 0.31 in
Minimum Bend Radius	8.0 cm 3.1 in	8.0 cm 3.1 in

PART NUMBER	DESCRIPTION
	Hybrid Jumpers for Nokia RRU (FHFB, FRIJ, FRIG, FXFC, FRIA, FRIB, FRIE pre-v202 and FASB integrated antenna)
HFT410-4SNOK2-xxx	End 1: 4 fibers terminated DLC with weatherproofing boot for Nokia RRUs with flush cut power cord (red/black conductors) End 2: 4 fibers terminated LC and 4-10AWG conductors terminated at HQLC (Senko IP25 Plug)

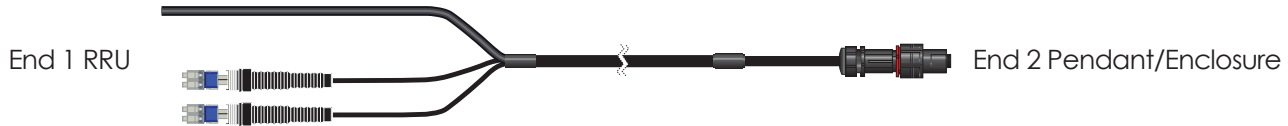

PART NUMBER	DESCRIPTION
	Hybrid Jumpers for Nokia RRU (AirScale ALHOA, AAFIA, AHFIB)
HFT410-4SNOK4-xxx	End 1: 4 fibers terminated DLC with R2CT weatherproofing shroud for Nokia AirScale radio with power connector End 2: 4 fibers terminated LC and 4-10AWG conductors terminated at HQLC (Senko IP25 Plug)

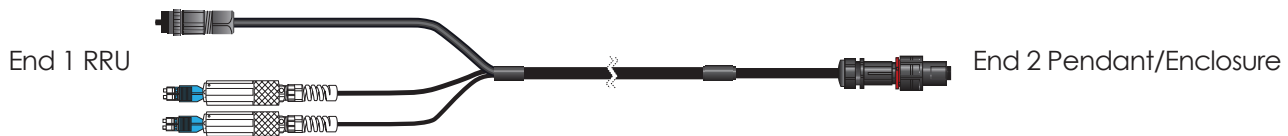

PART NUMBER	DESCRIPTION
	Hybrid Jumpers for Nokia Legacy RRU (FXFB, FRIE-v202) with Power Connector
HFT410-4SNOK5-xxx	End 1: 4 fibers terminated DLC with weatherproofing boot for Nokia RRUs with power connector End 2: 4 fibers terminated LC and 4-10AWG conductors terminated at HQLC (Senko IP25 Plug)



PART NUMBER	DESCRIPTION
	Hybrid Jumpers for Nokia RRU (AirScale AHFIG)
HFT206-4SNOK6-xxx	End 1: 4 fibers terminated DLC with weatherproofing boot for Nokia AirScale radio with R2CT weather shields and blunt-cut power leads End 2: 4 fibers terminated LC and 2-6AWG conductors terminated at HQLC (Senko IP25 Plug)

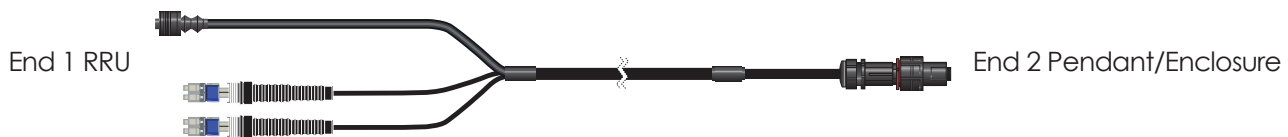

PART NUMBER	DESCRIPTION
HFT206-6SB41-xxx	Hybrid Jumpers for Nokia RRU (AirScale AAHF)
	End 1: 6 fibers terminated in 3 pairs DLC with Octis weatherproofing shroud. 55A DC power connector on 2-6AWG conductors.
	End 2: 6 fibers terminated in dual HQLC (Senko IP25) connectors, 4 fibers and 2-6AWG conductors in connector #1, 2 fibers in connector #2.



PART NUMBER	DESCRIPTION
HFT206-8SB41-xxx	Hybrid Jumpers for Nokia RRU (AirScale AEHC)
	End 1: 8 fibers terminated in 4 pairs DLC with Octis weatherproofing shroud. 70A DC power connector on 2-6AWG conductors.
	End 2: 8 fibers terminated in dual HQLC (Senko IP25) connectors, 4 fibers and 2-6AWG conductors in connector #1, 4 fibers in connector #2.



PART NUMBER	DESCRIPTION
DFJ-6S010-xxx	Discrete Fiber Jumpers with weatherproofing boot for Nokia Radios, 6 or 12 single mode fibers, armored
DFJ-12S010-xxx (shown)	End 1: DLC breakout with weatherproofing boot
	End 2: DLC breakout to enclosure

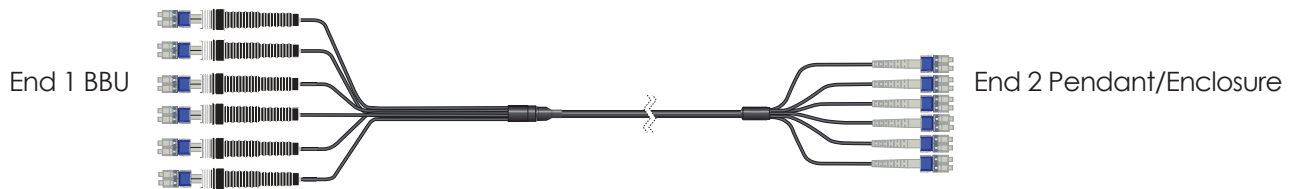

PART NUMBER	DESCRIPTION
DFJ-6S025-xxx	Discrete Fiber Jumpers for Nokia AirScale Radios, 6 or 12 single mode fibers, armored
DFJ-12S025-xxx (shown)	End 1: DLC breakout for Nokia systems module
	End 2: DLC breakout to enclosure

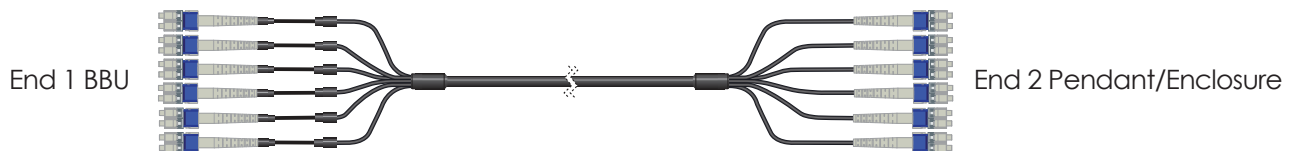

Section 6: HQLC Installation

1

Remove dust cap from pendant assembly by pulling back on red safety lock-ring. Rotate connector collar nut counter-clockwise and pull back. Remove Qty. 4 white ferrule dust caps. **DO NOT** remove caps from ports not being used.

Warning: DO NOT touch or place anything into power pins when site is powered up.

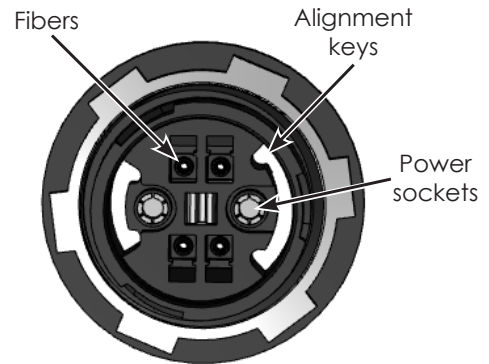
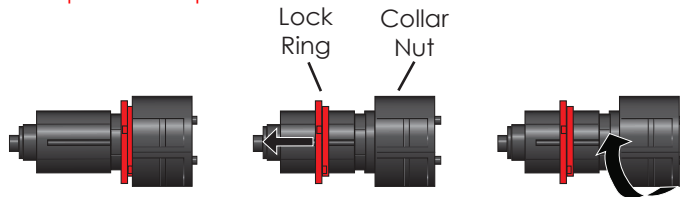

2

Remove dust cap from jumper assembly by pulling back on red Safety lock-ring. Rotate connector collar nut counter-clockwise and pull back. Pull forward on the dust cap. Remove Qty. 4 white ferrule dust caps.

Locate the alignment keys on the HQLC connector and the pendant. Insert the connector straight into the port making sure the keys are aligned correctly. Push until front seal is fully under adapter housing.

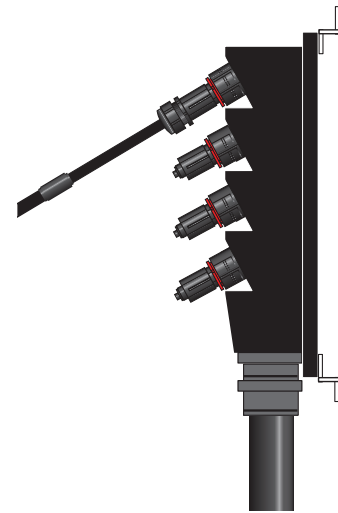
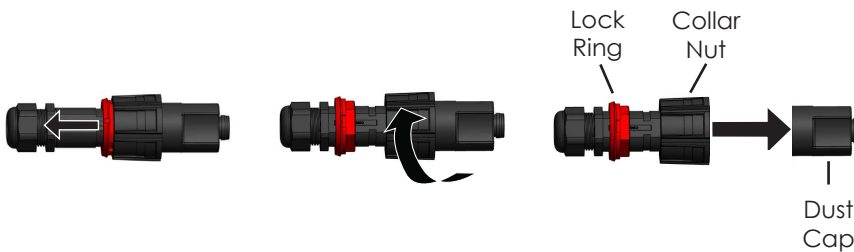

3

Engage the collar nut at pendant and twist clockwise ¼ turn until it stops and “click” is heard or felt. Slide the red safety lock-ring up and under the collar nut. Install a 20cm x 4.5mm UV rated cable tie for additional security. Collar nut should not be able to rotate once installed. Support jumper within 152 mm (6 in) from the back of the connector. **Verify the unused caps are tight before leaving the site as they provide the weather seal for the connector.**

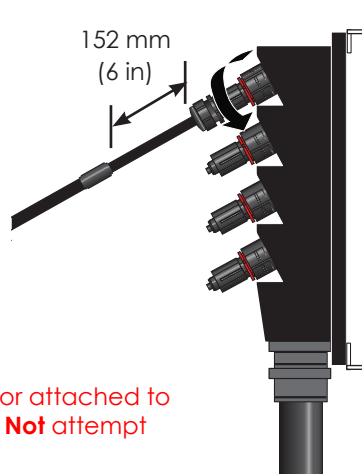
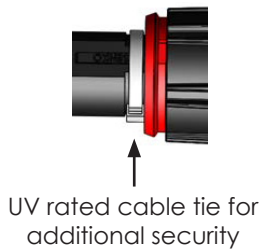

Be careful during final routing to avoid placing unwanted stress on the assembly



Warning: The female end of the connector attached to the pendant are not field removable. Do Not attempt to remove with wrench.

Section 8: Fiber/Power Mapping

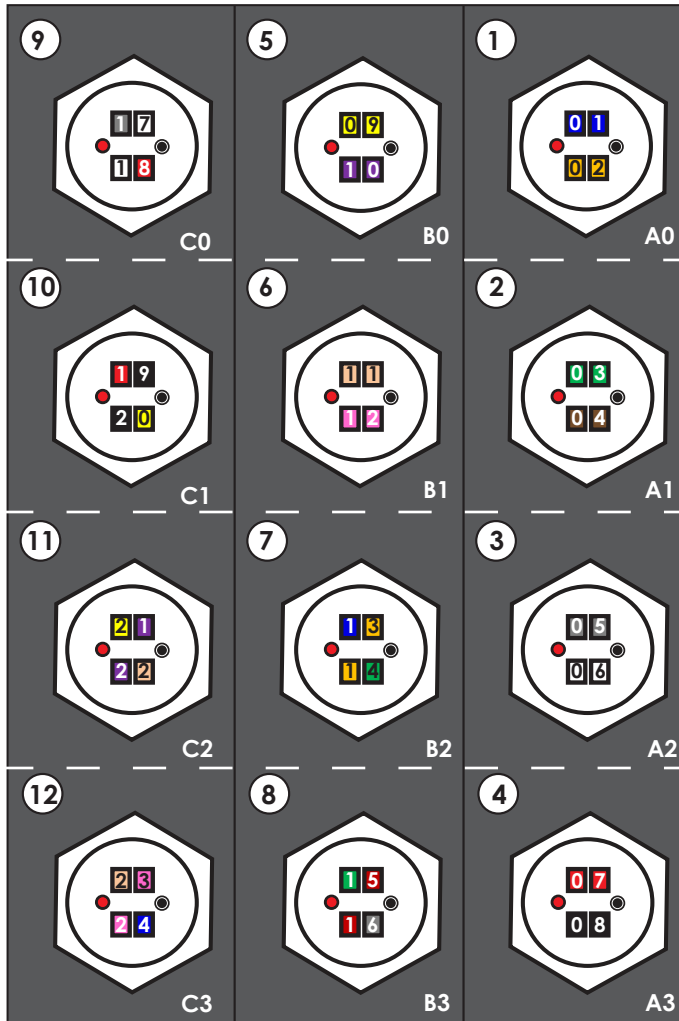

Power Pin's:

Pins on the left are RED when facing the connector.
 Pins on the right are BLACK when facing the connector

BBU ends are labeled per sector

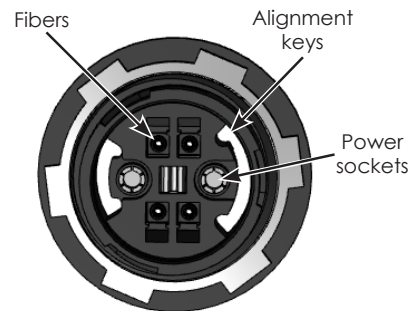

Bottom Junction Box

Radio 0		Radio 1		Radio 2		Radio 3		
Optical 1	Optical 2	Optical 1	Optical 2	Optical 1	Optical 2	Optical 1	Optical 2	
1	7	1	8	1	9	2	0	Gamma
0	9	1	0	1	1	1	2	Beta
0	1	0	2	0	3	0	4	Alpha

Section 9: FE-16148-OVP-B12 Junction Box Wiring Diagram

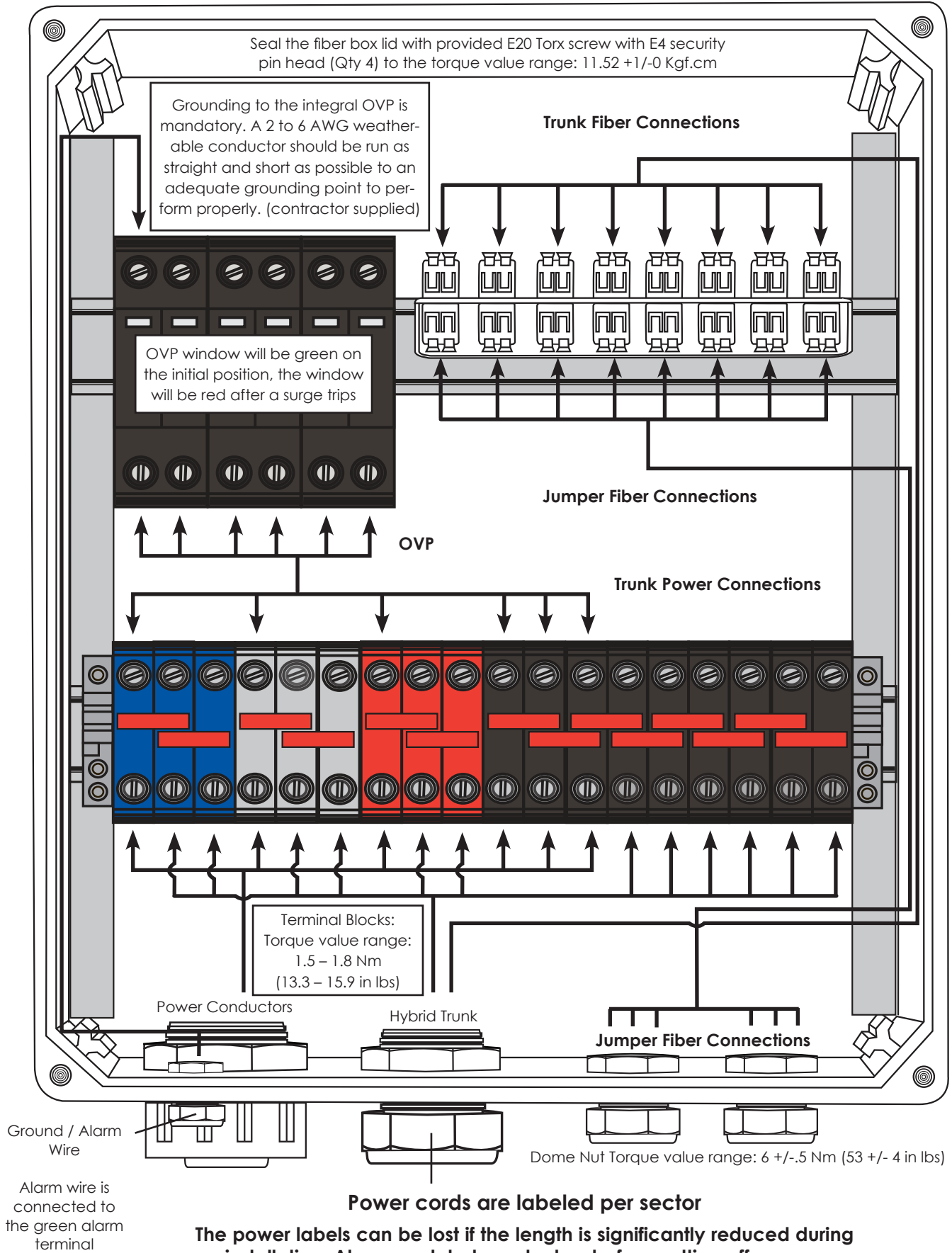

Fiber Adapter Panel

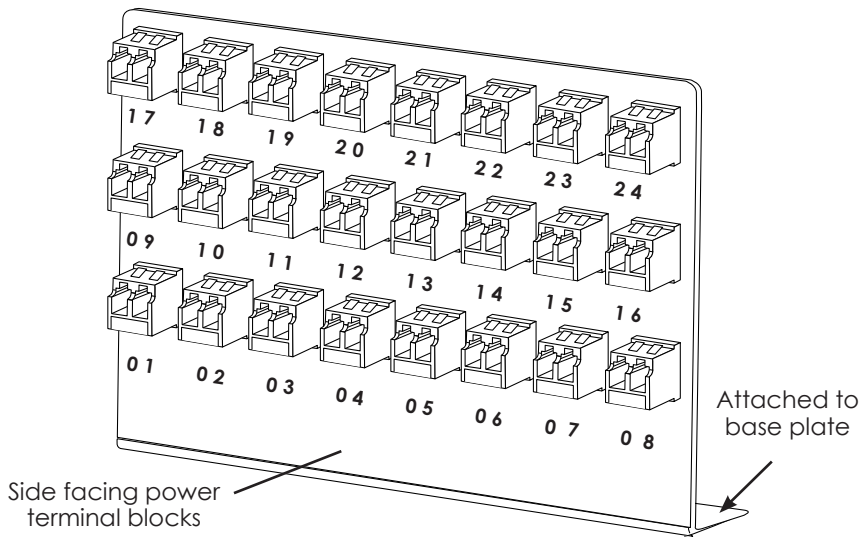

Radio 0		Radio 1		Radio 2		Radio 3										
Optical 1	Optical 2	Optical 1	Optical 2	Optical 1	Optical 2	Optical 1	Optical 2									
1	7	1	8	1	9	2	0	2	1	2	2	3	2	4	Gamma	
0	9	1	0	1	1	2	1	3	1	4	1	5	1	6	Beta	
0	1	0	2	0	3	0	4	0	5	0	6	0	7	0	8	Alpha

Alarm Wire Terminal

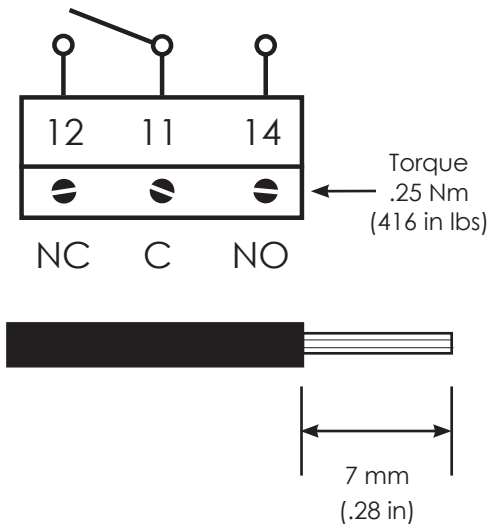

Alarm wire 30 - 18 AWG supplied by contractor

Junction Box (bottom view)

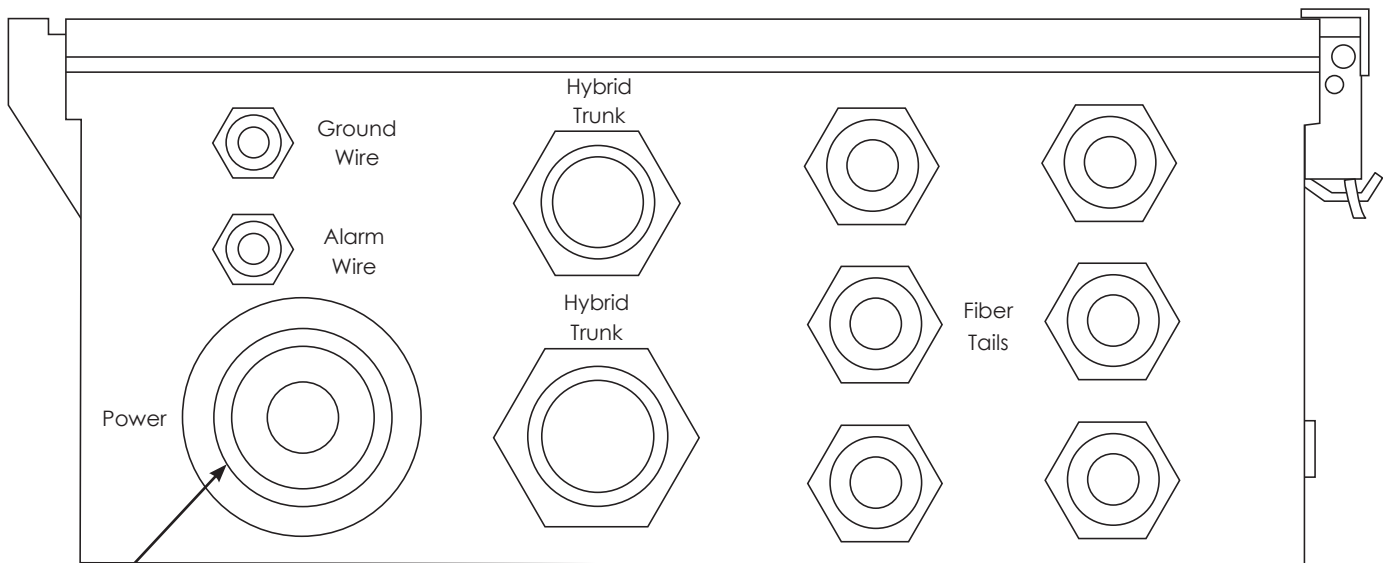

1 1/2 in
conduit fitting

Circuit Breaker Size Recommendation

Pendant	Amperage
12 RRU	90A

Section 10: Breakout Procedure

After the trunk cable has been installed and you are ready to make the final connection to the BBU follow these steps for the removal of fiber protection tube.

1



Remove electrical tape from the trunk cable and corrugated protection tube

2



While holding the protection tube straight pull the tube away from cable.

3



After you have pulled the fiber and power conductors into the OVP box remove electrical tape from the trunk cable and remove clear tube for access to all optical connectors.

DLC Connectors and Adapter cleaning

Clean exposed connector ferrule by lightly moistening lint-free wipe with fiber optic cleaning solution (or >91% isopropyl alcohol), and by applying medium pressure, first wipe against wet area and then onto dry area to clean potential residue from end face. Clean connector ferrule inside adapter by inserting lightly moistened cleaning stick with fiber optic cleaning solution (or >91% isopropyl alcohol) inside the adapter until contact is made with connector on opposite end. Rotate cleaning stick with medium pressure in one circular motion as it is pulled away from the adapter. Repeat process using dry cleaning stick.

Caution: Signal strength will be affected if end and sides of ferrule are not thoroughly cleaned. Discard cleaning sticks after each use. Do not turn cleaning sticks back and forth pressing against connector end face. This may cause scratches if large contamination is present. Always inspect connector end face for contamination after each cleaning.

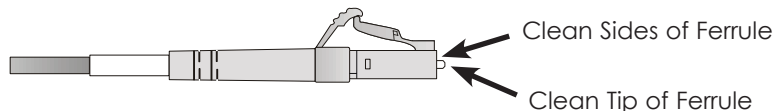

Clean adapter by inserting adapter cleaning stick (or fiber adapter sleeve brush) moistened with fiber optic cleaning solution (or >91% isopropyl alcohol) inside the adapter and gently pull out with twisting motion. Repeat process with a dry cleaning stick.

Caution: Do not try to clean adapter with a standard pipe cleaner. The sleeve inner diameter of DLC adapters is too small. Do not try to clean the adapter with cleaning stick if a connector is mounted in one side. Discard cleaning sticks after each use.



Section 11: All in one cleaner

Device designed for cleaning the ferrule end faces of LC connectors

Open guide cap, insert LC connector into guide, push the outer shell to start cleaning the LC connector interface, a "click" sound indicates end of a cleaning process, repeat, close cap immediately after use.

Caution: Be careful not to slant LC connector while inserting into the Guide cap. Do not overly exert force during insertion as this may cause damage to both the connector and the cleaner.

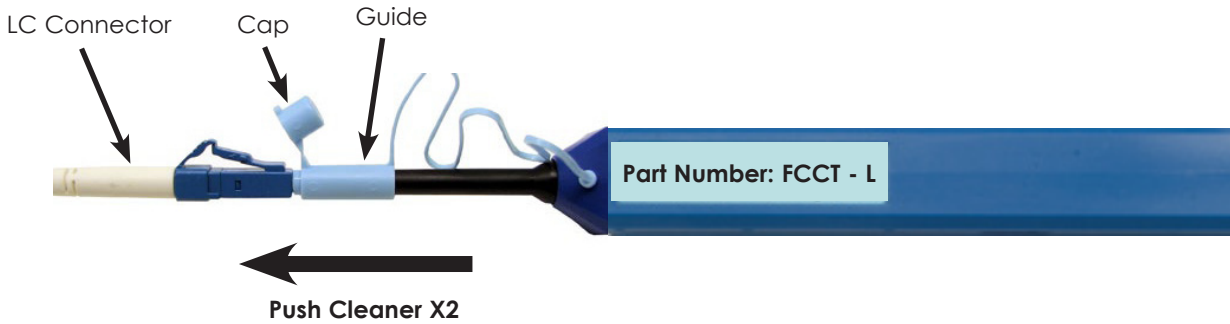

Inspecting

There are 3 basic principles that are critical to achieving an efficient fiber optic connection:

1. Perfect Core Alignment
2. Physical Contact
3. Pristine Connector Interface



Scan to view video

Today's connector design and production techniques have eliminated most of the challenges to achieving core alignment and physical contact. What remains challenging is maintaining a pristine end-face. As a result, CONTAMINATION is the #1 reason for troubleshooting optical networks.

Implementing the process of cleaning and inspecting before mating can reduce the time spent troubleshooting, optimize signal performance and prevent damage.

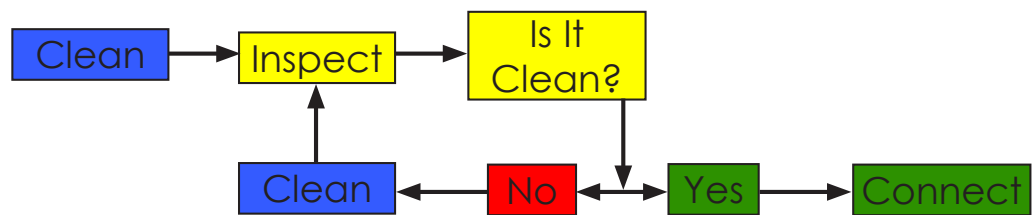

Abrasive particles (i.e. rock dust) can cause permanent damage to the interface. If interface is scratched it cannot be repaired, it would need to be replaced.

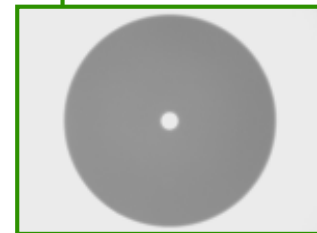
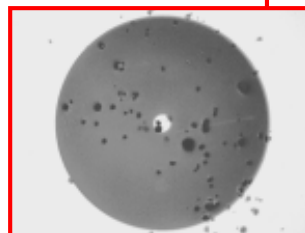





Section 12: Excess Cable Management

If length of cable installed needs to be adjusted you can split the cable at the BBU end using the process below and then coiling the excess fiber subunits in a storage box. Patch Panel Kits are available to manage any excess fiber length in the breakouts at the BBU.

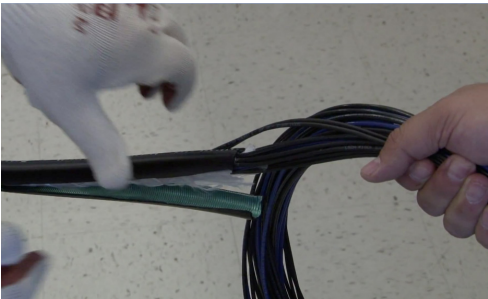

Scan to
view video

<p>1 Mark cutback length</p> 	<p>2 Notch Armor using flush cutter in-line with Kevlar strings</p> 
<p>3 Place Rip Cord in Notches'</p> 	<p>4 Pull Rip Cord Parallel to Cable (while supporting breakout)</p> 
<p>5 Stop at Length Marker</p> 	<p>6 Separate Armor</p> 

Excess Cable Management (continued)

7 Cut Armor Using Side Cutter



8 Remove Water Blocking Tape

NOTE:
Step can be expedited by using a sewing seam ripper that can be purchased at local hobby stores



9 Remove Excess Rip Cord



10 Apply Electrical Tape to Protect Breakout

NOTE:
Remember to slide identifier labels down the power conductors before trimming the cable to it's final length



Cable Splitter tool
Part Number:
FA-RCRT-PD



Seam Ripper

Section 13: Jacketing Removal Procedure for Universal Grounding Kit

1. Score the jacketing 360°
2. Measure 51 mm (2 in) and repeat
3. Identify where the aluminum shielding overlaps, this will feel like a flat spot in the cable
4. With a knife flat on the cable remove a section of jacketing between score marks
5. Lift edge of jacketing with knife tip
6. Grab lifted edge of jacketing with a pair of pliers and roll on the cable
7. Remove excess adhesive with a piece of emery cloth



Scan to
view video

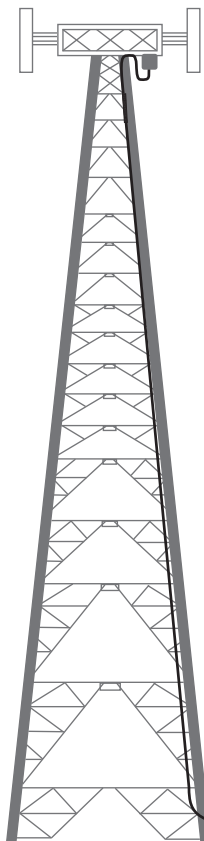

Earthing Kit **UG12158-15B4-T** is a universal solution for all trunk cables

Note: Only use Tin Plated earthing kits

Section 14: Installation Check List

- Tails are properly support to prevent strain on fiber during severe weather
- Bend radius minimums haven't been exceeded
- CommScope approved installation accessories are used
- Maximum hanger spacing of 0.9 m (3 ft) - 1.2 m (4 ft) is maintained
- Visually inspected end face for residual dirt and damage
- Avoid migration of contaminations from one connector to another
- Check continuity by using LED or laser light source from one end face and look for light from other end to identify any broken fiber (Do not look directly at cable with laser source)
- Fiber Connections are engaged and the sectors are consistent with requirements
- Verify dust caps on any unused Pendant interfaces have not come loose. Retighten if required.
- Cable serial number has been documented in the closeout paperwork and a copy has been left on-site

CommScope

1100 CommScope Place SE P.O. Box 339, Hickory, NC 28603-0339
 (828) 324-2200 (800) 982-1708
www.commscope.com

Technical Support

+1 888 297 6433, Option 3 (Toll Free US and Canada)
 +1 828 323 4220, Option 3 (local)
<https://www.commscope.com/wisupport> (open a ticket)

Notice: CommScope disclaims any liability or responsibility for the results of improper or unsafe installation, inspection, maintenance, or removal practices.
 Aviso: CommScope no acepta ninguna obligación ni responsabilidad como resultado de prácticas incorrectas o peligrosas de instalación, inspección, mantenimiento o retiro.
 Avis : CommScope décline toute responsabilité pour les conséquences de procédures d'installation, d'inspection, d'entretien ou de retrait incorrectes ou dangereuses.
 Hinweis: CommScope lehnt jede Haftung oder Verantwortung für Schäden ab, die aufgrund unsachgemäßer Installation, Überprüfung, Wartung oder Demontage auftreten.
 Atenção: A CommScope abdica do direito de toda responsabilidade pelos resultados de práticas inadequadas e sem segurança de instalação, inspeção, manutenção ou remoção.
 Avvertenza: CommScope declina eventuali responsabilità derivanti dall'esecuzione di procedure di installazione, ispezione, manutenzione e smontaggio improprie o poco sicure.
 注意: CommScope 公司申明對於不恰當或不安全的安裝、檢驗、維修或拆卸操作所導致的後果不負責任 何義務和責任

© 2020 CommScope