

PM-412-63



Adjustable Pipe Mount, 4-1/2 in OD x 63 in

Product Classification

Product Type Pipe mount

General Specifications

Mounting Saddle mounts

Note One 96 in x 8 in panel antenna per pipe mount

Pipe, quantity 1

Tower Taper Non-tapered

Dimensions

Height 1,600.2 mm | 63 in

Width 152.4 mm | 6 in

Length 152.4 mm | 6 in

Pipe Length 1,600.2 mm | 63 in

Pipe Outer Diameter 114.3 mm | 4.5 in

PM-412-63

Outline Drawing

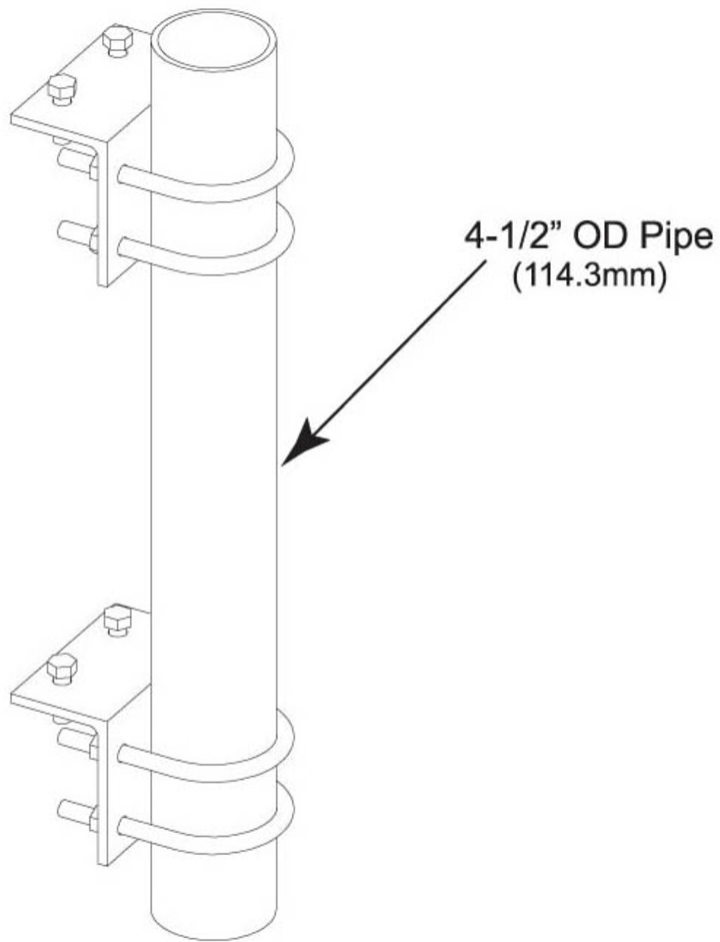

Material Specifications

Material Type Hot dip galvanized steel

Mechanical Specifications

Wind Rating 120 mph (BWS) at 150 ft AGL

Wind Rating Test Method TIA/EIA-222

Packaging and Weights

Included Brackets | Hardware | Pipe

Packaging quantity 1

PM-412-63

Weight, net 25.9 kg | 57.1 lb

Regulatory Compliance/Certifications

Agency

ISO 9001:2015

Classification

Designed, manufactured and/or distributed under this quality management system



Included Products

MT-653-63 – Plain End Pipe, 4-1/2 in OD x 63 in x .237" A500C
46Ksi

* Footnotes

Wind Rating BWS—Base Wind Speed; FBC—Florida Building Code