

# Installation Instructions

## Connector Attachment

For Braided Cable CNT-400  
N Male, Captivated Pin, Crimp-type Body

*Andrew Institute offers installation training.*

**Connector: 400APNM-CS8**

**Tools**

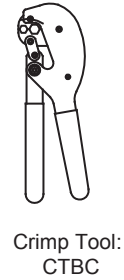
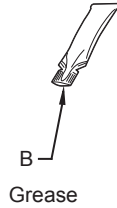
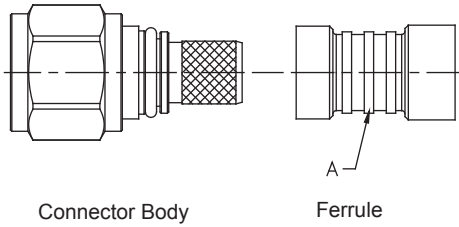

- 1.** Straighten the first 200.0 mm (7.874") min. of the cable.

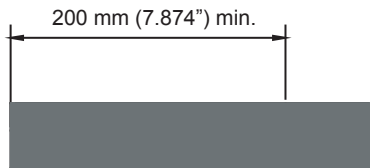

- 2.** Daub grease B onto cable uniformly as shown; Push and rotate part A onto cable as shown.

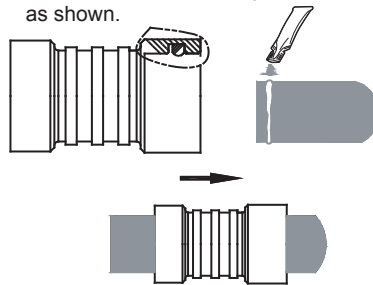

- 3.** Remove 19.0 mm (0.748") of Jacket only.

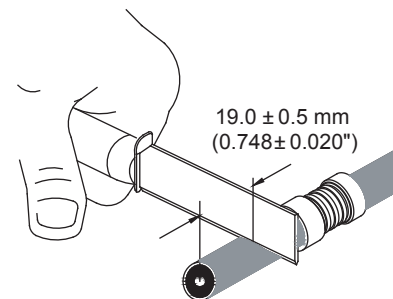

- 4.** Trim 9.0 mm (0.354") of braid, exposing outer conductor.

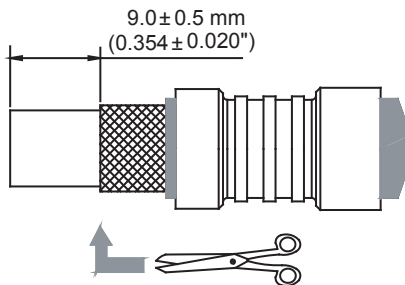

- 5.** Remove 7.0 mm (0.276") of foil & foam, exposing center conductor. Remove all foam/glue residue from the center conductor.

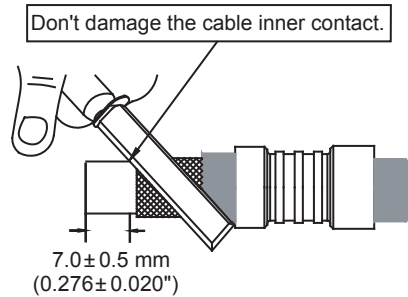

- 6.** Chamfer the center conductor at a 45° angle.

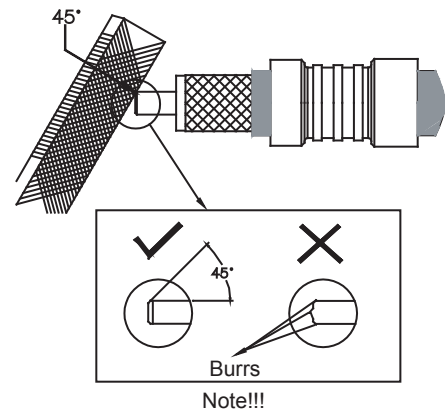

- 7.** Splay out braid as shown.

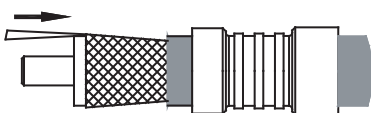

- 9.** The cable attachment must be straight and aligned with the hole of connector inner contact. Push the prepared cable attachment into connector body until stopped, the cable center conductor must be inserted into inner contact fingers. Make sure the braid cover the body sleeve, then twist part A onto braid until stopped.



- 8.** Daub grease B onto O ring circuit uniformly.

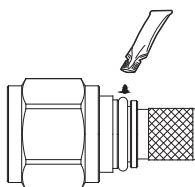

Clear all residual braid wires.

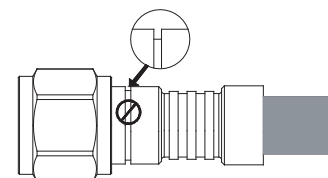
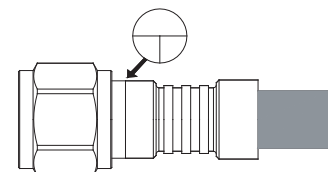
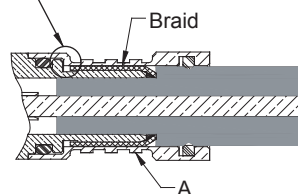

**10.** Crimp the ferrule at the area as shown.  
Crimp tool part number is: CTBC

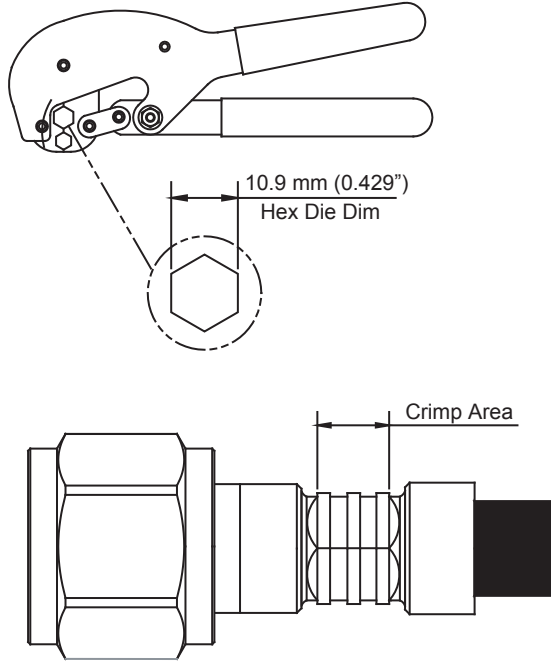

**11.** Coupling torque.

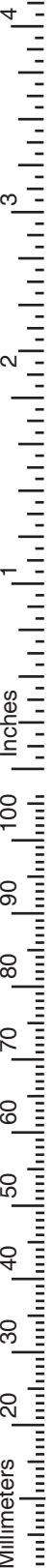
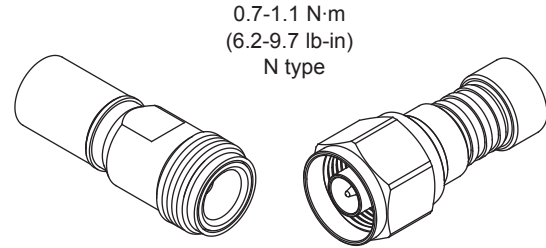

	表一 有毒有害物质或元素名称及含量标识格式					
	有毒有害物质或元素					
部件名称 (Part Name)	铅 (Pb)	汞 (Hg)	镉 (Cd)	六价铬 (Cr6+)	多溴联苯 (PBB)	多溴二苯醚 (PBDE)
连接器 (Connector)	X	O	O	O	O	O
O: 表示有毒有害物质在该部件所有的均质材料中的含量均在SJ/T 11363-2006规定的限量要求以下。 X: 表示该有毒有害物质至少在该部件的某一均质材料中的含量超出SJ/T 11363-2006规定的限量要求。						

**Andrew LLC**  
**Customer Service 24 hours**  
 U.S.A., Canada, Mexico: +1-800-255-1479  
 U.K.: 0800 250055 Brazil: +55-15-2102-4000  
 Other Europe: +44 592 782 612

[www.commscope.com](http://www.commscope.com)  
 Visit our Web site at [www.commscope.com](http://www.commscope.com) or contact your local Andrew LLC representative for more information.  
 © 2012 CommScope, Inc. All rights reserved.  
 Andrew LLC is a trademark of CommScope. All trademarks identified by ® or ™ are registered trademarks or trademarks, respectively, of CommScope. This document is for planning purposes only and is not intended to modify or supplement any specifications or warranties relating to Andrew LLC products or services.

Notice: Andrew LLC disclaims any liability or responsibility for the results of improper or unsafe installation, inspection, maintenance, or removal practices.  
 Aviso: Andrews LLC no acepta ninguna obligación ni responsabilidad como resultado de prácticas incorrectas o peligrosas de instalación, inspección, mantenimiento o retiro.  
 Avis: Andrew LLC décline toute responsabilité pour les conséquences de procédures d'installation, d'inspection, d'entretien ou de retrait incorrectes ou dangereuses.  
 Hinweis: Andrew LLC lehnt jede Haftung oder Verantwortung für Schäden ab, die aufgrund unsachgemäßer Installation, Überprüfung, Wartung oder Demontage auftreten.  
 Atenção: A Andrew LLC abdica do direito de toda responsabilidade pelos resultados de práticas inadequadas e sem segurança de instalação, inspeção, manutenção ou remoção.  
 Avvertenza: Andrew LLC declina eventuali responsabilità derivanti dall'esecuzione di procedure di installazione, ispezione, manutenzione e smontaggio improprie o poco sicure.  
 注意: Andrew公司申明對於不恰當或不安全的安裝、檢驗、維修或拆卸操作所導致的後果不負責任。何義務和責任